

Waikato stormwater management guideline

Updated version May 2020

Prepared by:
Earl Shaver (Aqua Terra International Limited)

Edited by:
Megan Wood (Wainui Consulting Limited)

For:
Waikato Regional Council
Private Bag 3038
Waikato Mail Centre
HAMILTON 3240

May 2020

Document #: 16316643

Peer reviewed by:

Megan Wood (Wainui Consulting Limited)

Judy Ansen (Coast and Catchment Limited)

Brian Richmond, Hugh Keane, Sung Soo Koh, Matthew Taylor, Duncan Grant (Waikato Regional Council)	Date	June 2018
---	------	-----------

May 2020 version peer reviewed by:	Date	April 2020
------------------------------------	------	------------

Megan Wood (Wainui Consulting Limited)

Brian Richmond (Waikato Regional Council)

Approved for release by:	Date	May 2020
--------------------------	------	----------

Brent Sinclair

Disclaimer

This technical report has been prepared for the use of Waikato Regional Council as a reference document and as such does not constitute Council's policy.

Council requests that if excerpts or inferences are drawn from this document for further use by individuals or organisations, due care should be taken to ensure that the appropriate context has been preserved, and is accurately reflected and referenced in any subsequent spoken or written communication.

While Waikato Regional Council has exercised all reasonable skill and care in controlling the contents of this report, Council accepts no liability in contract, tort or otherwise, for any loss, damage, injury or expense (whether direct, indirect or consequential) arising out of the provision of this information or its use by you or any other party.

Preface

Waikato Regional Council is pleased to release two new guidelines to address stormwater management: *Waikato stormwater management guideline* (TR2020/07) and *Waikato stormwater runoff modelling guideline* (TR2020/06).

Hamilton is the fourth largest city in New Zealand and while not equivalent in size to the large metropolitans, the population is forecast to increase 32 per cent between 2006 and 2031¹. The population in the Waikato Region grew faster than the national average between 2006 and 2013, with fastest growth experienced in the Waikato District (10.1%), Waipa District (9.8%) and Hamilton City (9.3%)².

The region supports over 35,000 km of streams and rivers, many of which are impacted by both rural and urban land use. The level of forecasted population growth in the region makes it imperative to ensure appropriate management of urban stormwater to help to protect our region's waterways from further degradation and to restore and enhance them.

The Waikato Regional Council has a number of statutory plans and policies that provide the framework to manage the region's natural resources and that support the formation of the Waikato Stormwater Management Guideline. The Te Ture Whaimana o Te Awa o Waikato – the Vision and Strategy is the prevailing document and is embedded within the Waikato Regional Policy Statement. Te Ture Whaimana o Te Awa o Waikato covers the Waikato and Waipa Rivers and their catchments. The entire Waikato Region and the remainder of the catchments not captured under the Te Ture Whaimana o Te Awa o Waikato are covered by the Waikato Regional Plan which must give effect to the Waikato Regional Policy Statement, which in turn must give effect to the National Policy Statement for Freshwater Management.

In producing these documents, the Waikato Regional Council would like to acknowledge the history of stormwater management and the many individuals who have contributed to progressing stormwater practice in New Zealand and overseas.

History of development and effort

Stormwater management best practice guidelines in use within the country largely have their origins with the Auckland Regional Council's (ARC's) documents: *Guidelines for stormwater runoff modelling in the Auckland Region* ("TP108" in 1999), *Stormwater treatment devices design guideline manual* ("TP10" in 1992 and an update in 2003) and *Low impact design manual* for the Auckland Region ("TP124" manual" in 2000). Research and promulgation emanated from monitoring of streams, estuaries and harbours that revealed issues around sediment and chemical contaminants, and the alteration of the timing and quantity of rainfall-runoff that comes with development. ARC's guidelines reflected overseas knowledge and practice, and research and characteristics of the Auckland region undertaken in the 1990s. In the 2000s Wellington Regional Council, Auckland City/Metrowater, North Shore City, Waitakere City, Christchurch City Council, Kapiti District Council and other cities and councils also progressed some of its own targeted research, while developing guidance or rules for stormwater management in its jurisdiction.

ARC continued to investigate stormwater under the Stormwater Action Plan that commenced in 2004, while Crown Research Institutes Landcare Research (e.g., Low Impact Design and Development research programme) and the National Institute for Water and Atmospheric Research (several stormwater and estuarine research programmes) progressed understanding and new tools. The University of Auckland and other universities undertook additional stormwater research. Guidelines produced in the 2010s incorporated the findings of the New Zealand and overseas research, including the Hawkes Bay and Bay of Plenty Regions stormwater guidelines and the New Zealand Transport Agency stormwater guideline.

¹ Waikato Regional Land Transport Programme 2012/13 – 2014-15

² <https://www.waikatoregion.govt.nz/Environment/Environmental-information/Environmental-indicators/Community-and-economy/p1a-report/p1a-data/> Viewed June 2018.

Overseas work drawn upon by the Waikato Regional Council and other agencies in New Zealand include research and practice that are embodied in technical reports and best practice guidelines from the United States Department of Agriculture National Resource Conservation Service (NRCS), United States Environmental Protection Agency, United States Federal Highway Agency, United States Corps of Engineers and proactive stormwater management localities including but not limited to the states of Delaware, Florida, Maryland, Washington and local or regional agencies such as the Denver Urban Drainage and Flood Control District, the city of Washington DC, the city of Portland Oregon and the city of Austin Texas. Research progressed by the American Society of Civil Engineers Environment and Water Resource Institute (ASCE EWRI) also has been utilised. Information was gleaned from several Australian Crown Research Centres (CRC) and university research, including the latest incarnation that addresses stormwater in a more holistic manner – the CRC for Water Sensitive Cities.

Content and differences

The Waikato Stormwater Management Guideline is based on Auckland Council's Technical Publication 10 (TP10) *'Stormwater Management Devices Design Guidelines Manual'* (Auckland Regional Council, 1992 and 2003) and replaces use of this guideline in the Waikato Region.

This guideline also builds on other guidance including the New Zealand Transport Agency's *'Stormwater Treatment Standards'*, Bay of Plenty Regional Council's *'Stormwater Management Guidelines for the Bay of Plenty Region'*, Hawkes Bay Regional Council's *'Waterway Guidelines Stormwater Management'* and Tauranga City Council's *'Stormwater Management Guidelines'*.

The two new guidelines importantly reflect the local characteristics of the Waikato Region. Previously stormwater design was based on ARC's documents, which incorporated a number of assumptions relevant to Auckland and which facilitated its implementation at the time. The Waikato guidelines return to the roots of TR-55 for its runoff calculations, while incorporating recommendations from the ASCE EWRI's recommendations to adjust the storage computation. The Waikato guideline further returned to the basis of the TR-55 method and adopts different soil groups than the assumptions in TP108, while requiring use of site specific soil information. As a result, the application is more scientifically valid for use in the Waikato than the Auckland guidance that they replace.

The consequence is that generally more runoff volume must be addressed to manage stormwater from what has been historically occurring in the region. Due to differences between catchments and soils in Auckland and the Waikato, the Auckland runoff modelling method results in devices that often are under-sized for Waikato conditions, and hence are not meeting expected performance, which leads to potential adverse effects. The Waikato guidelines will provide for devices and stormwater management that are designed for the Waikato Region conditions.

Another important aspect of the guidelines is the ongoing effort to address stormwater as part of urban development (i.e. low impact design, water sensitive cities) and at source rather than incorporating stormwater after the urban landscape has been designed or something appended at the bottom of the cliff. A low impact design scoring matrix is included in the guideline that enables quantification of how much low impact design has been incorporated into an urban development.

A new volume control criteria is included (in addition to existing peak flow control and water quality treatment criteria); developments will need to be designed to retain (reuse or soak) the initial abstraction volume of runoff. This criteria is to help offset the effects of impervious areas. Also, sections have been included on managing stormwater runoff from industrial areas, rural residential areas, and on managing the effects of urban stormwater runoff on Waikato Regional Council administered drainage districts. A specific section has been included on retrofitting stormwater management devices into existing built up areas.

Consultation

Consultation was undertaken in the development of this guideline, including:

- Internal consultation with Waikato Regional Council staff.
- Targeted workshops with territorial authorities.
- External workshops with key stakeholders including Iwi, territorial authorities, New Zealand Transport Agency, consultants, major industry representatives, surveyors, developers and Engineering New Zealand (Waikato Branch).

Feedback and companion guidance

Waikato Regional Council welcomes feedback on these guidelines as they are used in practice. As any guideline, amendments will be made to designs as new research and practice observation emerges that merit revisiting aspects within these guidelines.

Hard copies will not be sold or officially issued. It is the responsibility of the user of this guideline to ensure they download the most up-to-date version of the Waikato Stormwater Management Guideline.

The two new guidelines are among a series of best practice that Waikato Regional Council has published:

Principal Waikato Regional Council stormwater and related companion guidelines and documents:

- Waikato stormwater management guideline (TR2020/07).
- Waikato stormwater runoff modelling guideline (TR2020/06).
- Erosion and sediment control guidelines for soil disturbing activities (TR2009/02).
- Managing land use change and Council's administered drainage areas (TR2014/13).
- Environment Waikato best practice guidelines for waterway crossings (TR06/25R).

Acknowledgements

Waikato Regional Council would like to thank Judy Ansen from Coast and Catchment Limited for review comments that were received and that have been incorporated into this guideline.

Useful comments have also been received from Matthew Lillis (Hamilton City Council), Scott King (AECOM), Britta Jensen (Opus) and Iain Smith (Beca).

Waikato Regional Council would like to thank all of those who attended the first stakeholder workshop held on 28 February 2017 and who provided input to both guidelines. Representatives attended from Hamilton City Council, Hauraki District Council, Matamata-Piako District Council, South Waikato District Council, Taupo District Council, NZTA, Fonterra, AECOM, Beca, BBO, Civil Plan, CKL, MWH Global, Opus, Tonkin & Taylor, Wainui Environmental and Stormwater 360.

Waikato Regional Council would like to thank the following for their attendance at a meeting in Taupo on 1 November 2017 to discuss items relating to the stormwater management guidelines: Brent Aitken (Taupo District Council), Roger Stokes (Taupo District Council), Joanne Lewis (Lewis Consultancy Ltd), Mike Keys (Key Solutions Ltd) and Chris Todd (Todd Land Development Consultants Ltd).

Waikato Regional Council would like to thank the attendees at a targeted territorial authority workshop on 22 February 2018 to discuss the key changes in the approach from previous Auckland Council guidance that has been used in the Waikato. The following people attended this workshop: Andrea Phillips (Hamilton City Council), Matthew Lillis (Hamilton City Council), Mark Marr (Hamilton City Council), Sarah Pitches (Waipa District Council), Richard Pullar (Waikato District Council) and Scott Wilson (Opus – on behalf of Waikato District Council).

Waikato Regional Council would like to thank the attendees at a second targeted territorial authority workshop that was held on 12 March 2018. This workshop was held to discuss the low impact design scoring matrix and to score some existing development proposals. The following people attended this workshop: Andrea Phillips, Fraser McNutt, Jonathan Brooke, Martyn Smith and Mark Marr (all from Hamilton City Council), Mark Walmsley and Murray James (from Waipa District Council) and Britta Jensen (on behalf of Waikato District Council).

Waikato Regional Council would also like to thank those who attended the two further workshops held on 2 May and 10 May 2018 and for the feedback provided at both workshops. These two workshops were attended by representatives from Hamilton City Council, Hauraki District Council, Matamata Piako District Council, South Waikato District Council, Taupo District Council, Thames Coromandel District Council, Waikato District Council, Waipa District Council, New Zealand Transport Agency, Engineering New Zealand Waikato Branch, Fonterra, AECOM, Beca, Bloxam Burnett & Olliver, Blue Wallace, BTW Company, Cheal Consultants, CKL, Gray Consulting, Harrison Grierson, Hartland Environmental, Key Solutions Ltd, Lewis Consulting Ltd, Opus, PF Olsen NZ, Stantec, Stormwater 360, Tonkin and Taylor, Civil Plan, Wainui Environmental and Waikato Regional Council.

May 2020 Edition

Waikato Regional Council would like to thank all those that provided feedback on the first version of this guideline, and those that attended the three Territorial Authority workshops held in March and May 2019.

Table of Contents

Acknowledgements	iv
Part I: Stormwater management overview and orientation	1
1 Introduction	2
1.1 Overview	2
1.2 Principles of stormwater management	2
1.3 Best practicable option	4
1.4 How to use this guideline	4
2 Impacts of stormwater runoff	6
2.1 Hydrological cycle	6
2.2 Stormwater quantity	7
2.2.1 Flood effects	8
2.2.2 Case study – water quantity effects	9
2.3 Stormwater quality	10
2.3.1 Contaminant types	11
2.3.2 Contaminant sources	12
2.3.3 First flush	14
2.4 Stream morphology and aquatic resource	15
2.4.1 Bankfull discharge	15
2.4.2 Stream channel dimensions	16
2.4.3 Stream channel patterns	16
2.4.4 Stream channel profile	17
2.4.5 Stream ecology	17
2.4.6 Physical habitat	19
2.4.7 Ecological stress factors	20
2.4.8 Importance of first and second order streams	21
2.5 Cumulative effects	23
3 Waikato context	24
3.1 The Waikato Region	24
3.2 Regulatory framework	25
3.2.1 The Vision and Strategy	25
3.2.2 Waikato Regional Policy Statement	25
3.2.3 Relevant WRPS Policy Provisions	26
3.2.4 Waikato Regional Plan	27
3.2.5 Healthy Rivers Wai Ora: Plan for Change He Rautaki Whakapaipai	27
3.3 Tangata whenua and te taiao	28
3.3.1 Tangata whenua and water	29
3.3.2 Tangata whenua and the land	29
3.3.3 Tangata whenua and mauri	30
3.3.4 Joint management agreements in the Waikato	30
3.3.5 Iwi management plans	31
4 Receiving environments	32
4.1 Streams and rivers	32
4.1.1 Examples of impacted aquatic resources	34
4.2 Floodplains	34
4.2.1 Catchment size and slope	35
4.2.2 Surface conditions and land use	35
4.2.3 Floodplain topography	36
4.2.4 Floodplain values	36
4.3 Wetlands	37
4.4 Ground	39
4.4.1 Soil compaction	39

4.4.2	Contamination of soils	39
4.4.3	Migration of contaminants to groundwater	40
4.4.4	Soil type	41
4.5	Estuaries	44
4.6	Harbours	46
4.7	Open coasts	46
4.8	Lakes	47
4.9	Geothermal areas	48
4.10	Stormwater management and receiving environments	49
5	Stormwater management concepts	50
5.1	Avoid, remedy or mitigate	50
5.1.1	Avoid	50
5.1.2	Remedy	51
5.1.3	Mitigate	52
5.2	Low impact design	52
5.2.1	Achieve multiple objectives	53
5.2.2	Integrate stormwater design early in the process	53
5.2.3	Avoid rather than mitigate	53
5.2.4	Manage stormwater at-source	53
5.2.5	Rely on natural soil and plant processes	54
5.3	Approaches and techniques	54
5.3.1	Low impact design approaches	54
5.3.2	Low impact design devices	54
5.3.3	Clustering and alternative lot configuration	55
5.3.4	Reduce imperviousness	57
5.3.5	Minimise site disturbance	63
5.4	Cost of low impact design approach	64
5.5	Stormwater treatment processes	65
5.5.1	Sedimentation	65
5.5.2	Aerobic and anaerobic decomposition	68
5.5.3	Filtration and adsorption to filter material	69
5.5.4	Biological uptake	69
5.5.5	Biofiltration	70
5.5.6	Flocculation	71
5.6	Summary	71
Part II:	Stormwater management design	72
6	Choosing a stormwater management approach	73
6.1	Regulatory and design requirements	73
6.1.1	Design responsibility	73
6.1.2	Information requirements	73
6.1.3	Low impact design scoring approach	75
6.2	Individual device suitability	83
6.2.1	Site considerations	83
6.2.2	General constraints	86
6.2.3	Contaminant generation	90
6.2.4	Contaminant removal processes	92
6.2.5	Device selection	94
6.2.6	Treatment train approach	95
7	Design criteria	99
7.1	Water quantity design	99
7.1.1	Preventing existing flooding problems from getting worse	99
7.1.2	Controlling intermediate storms	100
7.1.3	Catchment location	102
7.1.4	Design rainfall	102
7.1.5	Hydrologic design method	102

7.1.6	Effects of climate change	103
7.1.7	Peak flow control criteria	105
7.2	Stream channel erosion	105
7.2.1	Runoff volume control	106
7.2.2	Detention time control	108
7.2.3	General discussion	108
7.2.4	What criteria should be established?	109
7.2.5	Where the criteria should be applied	109
7.2.6	Water quality credit for extended detention	109
7.2.7	Erosion control criteria	110
7.2.8	Lands within and draining into Hamilton City Council jurisdiction	112
7.3	Water quality design	112
7.3.1	General sizing requirements	112
7.3.2	Effluent limits versus best practicable option	114
7.3.3	Water quality treatment criteria	115
7.4	Summary of recommendations	115
7.4.1	Peak flow control	115
7.4.2	Stream erosion control	116
7.4.3	Water quality treatment	118
8	Stormwater management device design	119
8.1	Introduction	119
8.2	Source control	119
8.3	Designing for ease of operation and maintenance	119
8.3.1	Spend a year at the practice	119
8.3.2	Maintenance questions	120
8.3.3	Uniform materials or components	120
8.4	Designing for safety	121
8.5	Specific design guidance for stormwater management devices	121
8.5.1	Swales	123
8.5.2	Filter strips	133
8.5.3	Sand filters	138
8.5.4	Bioretention	145
8.5.5	Infiltration	162
8.5.6	Stormwater pond	172
8.5.7	Wetlands	190
8.5.8	Green roofs	206
8.5.9	Bush revegetation	211
8.5.10	Water tanks	215
8.5.11	Compacted soil remediation	224
8.5.12	Oil/water separators	228
9	Outlet design	230
9.1	Introduction	230
9.2	Design references	231
9.3	Design approach	231
9.3.1	Pipe or channel grade	231
9.3.2	Inlet and outlet velocities	231
9.3.3	Riprap aprons	232
9.3.4	Engineered energy dissipators	233
9.3.5	Outfalls to channels	234
9.3.6	Outfalls in coastal areas	235
9.4	Detailed design	236
9.5	Construction	238
9.6	Operation and maintenance	238
10	Landscaping	240
10.1	Introduction	240
10.2	Objective	240

10.2.1 Aesthetic appeal of stormwater devices	240
10.2.2 Water quality and ecological function	241
10.2.3 Economic value of the site	241
10.3 Native vegetation	241
10.4 General landscape guidance	242
10.4.1 Stormwater device area	242
10.4.2 Landscape screening	242
10.4.3 Soils	242
10.4.4 Site preparation	242
10.4.5 Planting	243
10.4.6 General guidance	243
10.5 Specific landscape provisions for individual devices	244
10.5.1 Ponds and wetlands	244
10.5.2 Infiltration and filter devices	245
10.5.3 Swales and filter strips	246
10.5.4 Green roofs	247
11 Proprietary devices and innovative products	248
11.1 Introduction	248
11.2 Approval options	248
11.2.1 Approval through another certification process	248
11.2.2 Information submission to Waikato Regional Council	250
11.3 Information requirements	251
11.4 Information required to determine adequacy of monitoring data	252
11.4.1 Catchment parameters	252
11.4.2 Device design parameters	252
11.4.3 Water quality analysis	253
11.5 Discussion	254
12 Contaminant loads	255
12.1 Introduction	255
12.2 Determining water quality loads	255
12.3 Auckland Council's contaminant load model	255
12.4 Recommended approach	256
12.4.1 Rainfall differences	256
12.4.2 Local soils	258
12.4.3 Case study – Contaminant load model	258
12.5 Summary	259
Part III: Different site applications for stormwater management	260
13 Industrial site management	261
13.1 Introduction	261
13.2 Source control and housekeeping	261
13.2.1 Importance of having site plans	261
13.2.2 Stormwater pipes, their inlets and outlets	262
13.2.3 Outdoor areas	263
13.2.4 Stormwater and wastewater systems	263
13.2.5 Housekeeping	263
13.2.6 Roofs	266
13.3 Industries, contaminants and treatment devices	266
13.4 Stormwater management devices	273
13.4.1 Stormwater management ponds	274
13.4.2 Constructed wetlands	275
13.4.3 Sand and sand/peat filters	275
13.4.4 Bioretention	276
13.4.5 Infiltration devices	277
13.4.6 Swales and filter strips	278
13.4.7 Oil and water separators	279

13.4.8	Oxidation	279
13.5	Conclusion	280
14	Rural residential development	281
14.1	Introduction	281
14.2	Key objectives	281
14.3	General principles	281
14.4	Source, flowpaths and receiving environments	282
14.4.1	Source	282
14.4.2	Pathway	282
14.4.3	Receiving environment	285
14.5	Hydrology	286
14.5.1	An individual residence	286
14.5.2	Rural residential subdivision	286
14.5.3	Device capability to detain flows	286
14.6	Stormwater management device design	288
15	Waikato Regional Council administered drainage areas	289
15.1	Introduction	289
15.2	Drainage standards	290
15.3	Problem identification	291
15.4	Urban development issues	292
15.5	Land use change and drainage areas	293
15.5.1	Introduction	293
15.5.2	Site specific criteria	293
15.5.3	Information requirements	293
15.5.4	Information requirements for small scale subdivision	294
15.5.5	Information requirements for larger scale development	294
15.5.6	Funding	295
15.5.7	Land ownership	296
15.6	Conclusion	296
16	Retrofitting stormwater management	297
16.1	Introduction	297
16.2	Retrofit process	297
16.3	Prioritisation of projects	298
16.4	Magnitude of impact	299
16.4.1	Public safety	299
16.4.2	Collaborative projects	299
16.4.3	Water quality retrofits	299
16.4.4	Stream erosion reduction	300
16.5	Device availability	301
16.5.1	Downstream flooding impacts	301
16.5.2	Downstream channel erosion effects	301
16.5.3	Stormwater quality	302
16.6	Space availability	303
16.7	Positive drainage	303
16.8	Magnitude of benefit	303
16.9	Cost	303
16.9.1	Cost benefit analysis	303
16.9.2	Total cost	304
16.9.3	Total cost for the maintenance programme	304
16.10	Taking advantage of opportunities	305
16.10.1	Retrofitting existing stormwater quantity control structures	305
16.10.2	Using existing road crossings to impound stormwater	306
16.10.3	Demonstration projects	306
16.10.4	Use of new consenting to exceed individual project benefits	307

16.10.5	Retrofitting through education	307
Part IV:	Construction, operations and maintenance	308
17	Construction related issues	309
17.1	Introduction	309
17.2	Responsibility for construction	309
17.3	Pre-construction activities	311
17.4	Device construction	311
17.4.1	Swale and filter strip construction	311
17.4.2	Sand filters	314
17.4.3	Bioretention devices	315
17.4.4	Infiltration	316
17.4.5	Ponds and wetlands	318
17.4.6	Green roofs	321
17.4.7	Water tanks	322
17.4.8	Bush revegetation	323
17.4.9	Oil/water separators	323
17.5	Final acceptance	324
17.6	Inspection reports and construction notes	324
17.7	Construction inspection checklists	324
18	Operation and maintenance	325
18.1	Introduction	325
18.2	Inspection and maintenance	326
18.2.1	Device inspection frequencies	326
18.2.2	Timing of device maintenance	341
18.3	Documenting inspection and maintenance	346
18.4	Prioritising maintenance tasks	346
18.4.1	Corrective maintenance	347
18.4.2	Preventive maintenance	347
18.4.3	Aesthetic maintenance	347
18.5	Disposal of removed contaminants	348
18.6	Safety issues	349
18.7	Inspection reports and operational notes	349
18.8	As-built certification	349
	References	351
Appendix A:	Glossary of terms	359
Appendix B:	Low impact design scoring matrix	364
Appendix C:	Forms for construction and operation	368
	Pre-construction meeting form	370
	Device construction forms	376
	As-built documentation forms	379
	Operation and maintenance forms	401

Figures

Figure 2-1: Hydrological cycle	6
Figure 2-2: Changes in the hydrological cycle as a result of urbanisation	7
Figure 2-3: Stormwater hydrographs – pre-and post-development	8
Figure 2-4: Hydrograph comparison for pre and post development scenarios	10
Figure 2-5: Effects of urbanisation on stream cross section	15
Figure 2-6: Stream cross section showing velocity distributions	16
Figure 2-7: Stream channel geometry	17
Figure 2-8: Sensitive aquatic organisms versus impervious surface percentages	21
Figure 2-9: Conceptualisation of a stream hierarchy	21
Figure 4-1: Groundwater movement	41
Figure 4-2: Location of pumice soils in the Central North Island ³⁶	42
Figure 4-3: Location of organic soils in the Central North Island ³⁸	43
Figure 5-1: Conventional site development versus an LID approach	56
Figure 5-2: Turnaround options	60
Figure 5-3: Parking area dimensions	61
Figure 5-4: Comparison of individual and combined driveways	63
Figure 5-5: Particle size and general classification	67
Figure 5-6: Wetland process for denitrification	68
Figure 6-1: Development process and stormwater management design	80
Figure 6-2: Pre-development site showing land use	81
Figure 6-3: Conventional site development	81
Figure 6-4: Low impact design approach	82
Figure 6-5: Slope versus available storage	85
Figure 6-6: Groundwater schematic	86
Figure 6-7: Groundwater mounding under an infiltration practice ⁶⁵	87
Figure 6-8: Slope and seepage from an infiltration trench	87
Figure 7-1: Pre and post-development 100-year ARI peak flow rates in a catchment	100
Figure 7-2: Comparison of flood frequency curves for various stormwater policies ⁷⁹	101
Figure 7-3: Average days between rains per month	107
Figure 7-4: Discharge versus flow duration for pre and post development scenarios	108
Figure 7-5: Frequency distribution of runoff events ⁹¹	113
Figure 7-6: 90th percentile storm at different locations within the Waikato Region ⁹²	113
Figure 8-1: Swale with check dams and diversion of lateral inflow	126
Figure 8-2: Swale channel geometry	128
Figure 8-3: Swale schematic showing soils and underdrain	129
Figure 8-4: Schematic of a filter strip	135
Figure 8-5: Sand filter basin	139
Figure 8-6: Vault sand filter ¹⁰³	139
Figure 8-7: Linear sand filter ¹⁰³	140
Figure 8-8: Diversion weir ¹⁰³	141
Figure 8-9: Large flow bypass schematic ¹⁰³	142
Figure 8-10: Schematic of bioretention device key elements and flow paths	146
Figure 8-11: Schematic of a rain garden cross section ¹⁰⁸	147
Figure 8-12: Schematic of a planter box cross section	148
Figure 8-13: Schematic of a planter box cross section ¹⁰⁹	149
Figure 8-14: Schematic of a bioretention swale cross section ¹⁰⁹	149
Figure 8-15: Bioretention device with a submerged zone	151
Figure 8-16: Schematic of an infiltration basin	163
Figure 8-17: Schematic of an infiltration trench ¹¹⁹	164
Figure 8-18: Schematic of a soakage pit	164
Figure 8-19: Schematic of permeable pavement ¹¹⁶	165
Figure 8-20: Schematic of a stormwater management pond	175
Figure 8-21: Pond cross-sections ¹²⁴	176
Figure 8-22: Design detail for a filter collar	176
Figure 8-23: Schematic of safety benches and slopes	180
Figure 8-24: Schematic of pond outlet components	181
Figure 8-25: Example of an orifice cover plate to prevent clogging	182
Figure 8-26: Schematic of extended detention outlet structures ¹²⁷	184
Figure 8-27: Banded bathymetric wetland schematic	195

Figure 8-28: Cross-section of a wetland swale	199
Figure 8-29: Longitudinal slope on a wetland swale	200
Figure 8-30: Channel geometry ¹³⁷	202
Figure 8-31: Wetland case study – percentage areas	205
Figure 8-32: Green roof cross-section showing components	207
Figure 8-33: Case study parameters for a green roof ¹³⁹	210
Figure 8-34: Bush revegetation for runoff control	214
Figure 8-35: Annual rainfall throughout the region	217
Figure 8-36: Calculation of roof surface areas	218
Figure 8-37: Combination attenuation and water use tank	220
Figure 8-38: Water tank detention storage volumes	220
Figure 8-39: Water tank schematic showing case study elevations and volumes	223
Figure 8-40: Orifice and exterior pipe details	223
Figure 8-41: Infiltration rates for sandy soil conditions	225
Figure 8-42: Infiltration rates for clayey soil conditions ¹⁴⁸	225
Figure 9-1: Engineered stilling basin	233
Figure 9-2: Set back outfall into a stream ¹⁵⁰	235
Figure 9-3: Schematic of riprap outfall protection ¹⁵⁵	237
Figure 13-1: Typical industrial site showing various site elements	262
Figure 14-1: Example of a small rural residential development	285
Figure 15-1: Waikato Regional Council and territorial authority drainage areas	290
Figure 16-1: Retrofit process	298
Figure 16-2: Auckland Council stormwater demonstration area	306

Tables

Table 2-1: Typical urban stormwater contaminants	11
Table 2-2: Sources of urban stormwater contaminants	12
Table 2-3: Impacts of urbanisation on aquatic ecosystems	18
Table 2-4: Order of streams and rivers in the Waikato Region	22
Table 4-1: Values of the Mannings roughness coefficient ‘n’ in floodplains	35
Table 4-2: Summary of wetland functions and values	38
Table 4-3: Receiving environments and stormwater issues	49
Table 5-1: Comparison of capital costs for LID	64
Table 5-2: Particle characteristics	66
Table 5-3: Metals distribution and particle sizes	66
Table 5-4: Particle size versus settling velocity	67
Table 5-5: Ability of biota to uptake contaminants	70
Table 6-1: Low impact design scoring matrix	75
Table 6-2: Target scores (excluding highway projects)	76
Table 6-3: Target scores for highway projects	76
Table 6-4: Infiltration rate for various soil textural classes	84
Table 6-5: Soil and suitability of various stormwater management devices	84
Table 6-6: Slope limitations of various stormwater management devices	85
Table 6-7: Stormwater management devices related to catchment areas	86
Table 6-8: Contaminant loads for various daily traffic counts	91
Table 6-9: Contaminant discharges from roofing materials ⁷⁴	91
Table 6-10: Summary of contaminant removal mechanisms	93
Table 6-11: Stormwater management device capabilities	94
Table 6-12: Treatment train examples	95
Table 6-13: Removal rates for various stormwater devices	98
Table 7-1: Maximum permissible velocities	106
Table 8-1: Site suitability parameters	123
Table 8-2: Swale design elements	124
Table 8-3: Flow depth vs. Manning’s n versus discharge	131
Table 8-4: Filter strip design elements	134
Table 8-5: Sand specification	143
Table 8-6: Main components of a bioretention device ¹⁰⁷	150
Table 8-7: Site design considerations for bioretention devices	152
Table 8-8: Design considerations for bioretention devices ¹⁰⁷	153

Table 8-9: Bioretention device planting media specification	156
Table 8-10: Recommendations for trees and shrubs	157
Table 8-11: Grasses, ground covers and other plants	158
Table 8-12: Infiltration device components ¹⁰⁷	165
Table 8-13: Site constraints for the use of infiltration devices	166
Table 8-14: Case study – stormwater pond summary table	187
Table 8-15: Stage-storage relationships	188
Table 8-16: Stormwater contaminant removal mechanisms of constructed wetlands	191
Table 8-17: Site considerations for wetlands ¹⁰⁷	192
Table 8-18: Design considerations for wetlands ¹⁰⁷	192
Table 8-19: Vegetation suitable for wetlands	198
Table 8-20: Wetland case study - summary table	204
Table 8-21: Bush planting requirements	213
Table 8-22: Estimated residential water demand for a 3 member household	218
Table 8-23: Building occupancy ratios for different activities	219
Table 9-1: Maximum permissible velocities for unlined channels	232
Table 11-1: Evaluation criteria for water quality treatment devices in Switzerland	249
Table 12-1: Urban contaminant yields for use in the Waikato Region	257
Table 13-1: Industrial activities contaminants and treatment processes	267
Table 13-2: Summary of contaminant removal mechanisms	273
Table 14-1: Recommended design values of Manning’s roughness coefficients	283
Table 14-2: Maximum permissible velocities for unlined channels	284
Table 15-1: Drainage runoff design standard	291
Table 15-2: Information requirements	293
Table 16-1: Zinc and copper contaminant levels in runoff ¹⁷²	302
Table 18-1: Recommended maintenance schedule for swales and filter strips	327
Table 18-2: Recommended maintenance schedule for sand filters	328
Table 18-3: Troubleshooting for sand filters	330
Table 18-4: Recommended maintenance schedule for bioretention devices	331
Table 18-5: Troubleshooting for bioretention devices	332
Table 18-6: Recommended maintenance schedule for wetlands	335
Table 19-7: Trouble shooting for wetland	338
Table 18-8: Physical function impairment criteria	342
Table 18-9: Initial monitoring timeframes for stormwater devices	345
Table 18-10: Heavy metal concentrations in sediments from stormwater devices	348
Table 18-11: Heavy metal concentrations from stormwater devices by land use type ¹⁸²	348

Part I: Stormwater management overview and orientation

1 Introduction

1.1 Overview

The Waikato Region is increasingly facing natural resource constraints from a growing population. There are pressures on our soil, water, air, coastal areas, biodiversity and other natural resources and existing infrastructure. Sustainable growth – developing our economy without harming the environment upon which it depends – is important for our future. An important aspect of sustainable growth is ensuring a low impact design or water sensitive design approach is taken to reduce the impact of stormwater from urban areas.

This document provides guidance for engineers, planners, landscape architects, developers, and contractors in selecting, designing, constructing and maintaining stormwater management systems for urban areas, with a focus on encouraging a low impact design approach.

Additional insight on the topics presented in this guideline may be found by studying the papers and documents listed in the references section.

The guideline provides design criteria and standards recommended by Waikato Regional Council. Designing stormwater management systems that go beyond minimum design criteria is encouraged. In addition, there may be other requirements by local authorities or the New Zealand Transport Agency that need to be met in addition to the minimum design criteria provided in this guideline.

1.2 Principles of stormwater management

Adequate stormwater management for urban and rural areas is necessary to preserve and promote the general health, welfare, enhancement of ecological values and economic wellbeing of the Waikato Region. Stormwater management is a catchment issue that affects all parcels of land in some way or form. This characteristic of stormwater management makes it necessary to formulate a programme that considers the whole of catchment where practicable. Overall, the local authorities most directly involved must provide coordination and master planning, but drainage planning must also be integrated on a catchment level.

The general principles outlined in the section below provide direction for planning stormwater management systems. When considered in a comprehensive manner, at a catchment level, stormwater management devices can enhance general health and wellbeing of the region and assure optimum economic and social relationships while avoiding uneconomic flood losses and disruption and environmental degradation.

Council's general principles and policies for stormwater management and floodplain management are briefly summarised below:

1. Stormwater management is a catchment-based issue that crosses territorial boundaries. This makes it necessary to develop programmes at a catchment level. Overall, the territorial authorities most directly involved must provide coordination and catchment management planning or master planning, but stormwater catchment planning must be integrated at a catchment level if optimum results are to be achieved.
2. A stormwater system is a subsystem of the total water resource system. Stormwater system planning and design for any site must be compatible with comprehensive catchment plans and should be coordinated with planning for land use, open space and transportation. Erosion and sediment control, flood control, water quality and ecological values all closely interrelate with stormwater management. Any catchment management plan or site specific stormwater management plan should address all of these considerations.
3. Every urban area has a primary and secondary stormwater system, whether or not they are planned and designed. The primary system is designed to provide public convenience and to accommodate moderate, frequently occurring flows. The secondary

system carries more water and operates when the rate or volume of runoff exceeds the capacity of the primary system. Both systems should be carefully considered.

4. Stormwater runoff routing is primarily a space allocation problem. The volume of water present at a given point in time cannot be compressed or diminished. Channels and stormwater systems serve both conveyance and storage functions. If provision is not made for adequate space for stormwater, runoff will conflict with other land uses, result in damages, and impair and disrupt the functioning of other urban systems.
5. Planning and design of stormwater systems should not be based on the premise that problems can be transferred from one location to another, i.e. downstream.
6. A stormwater management system should address multi objectives and values. The many competing demands placed upon space and resources within an urban area mean that stormwater management should meet a number of objectives, including water quality treatment, groundwater recharge, ecological habitat, protection of landmarks/amenities, erosion and sediment control, and creation of open spaces/recreation areas.
7. Design of stormwater management systems should consider the values of the existing site features. Every site contains natural features that contribute to stormwater management without significant modification. Such as natural streams, depressions, wetlands, gullies, floodplains, permeable soils and vegetation provide for infiltration, help reduce runoff velocities, extend the time of concentration, filter sediments and other contaminants and recycle nutrients. Each development proposal should consider how to incorporate, protect and enhance existing natural site features.
8. In conjunction with new development and re-development, efforts should be made to minimise increases in, and reduce where possible, stormwater runoff volumes, flow rates, and contaminant loads to the maximum extent practicable. Key practices include:
 - Retaining site perviousness and natural drainage paths.
 - The rate of runoff should be slowed with preference given to stormwater management systems that maximise vegetative and pervious land cover. Existing best practice normally requires control of peak flows to predevelopment levels to the maximum extent practicable, and control of runoff volumes for smaller, frequently occurring events and volume reduction.
 - Water quality treatment is best accomplished by implementing a series of measures, which can include source control, minimising directly connected impervious areas, and construction of on-site and subdivision/growth cell facilities to manage stormwater quality and quantity effects. Implementing measures that reduce the volume of runoff through infiltration and disconnection of impervious areas is one of the most effective means for reducing the pollutant load delivered to receiving waters.
9. The stormwater management system should be designed beginning with the discharge point for the site, giving full consideration to downstream effects. The downstream system should be evaluated to ensure that it has sufficient capacity to accept design discharges without adverse upstream or downstream effects such as flooding, stream bank erosion and sediment deposition.
10. Stormwater management systems require regular maintenance. Failure to provide proper maintenance reduces the hydraulic capacity and contaminant removal efficiency of the system. Local maintenance capabilities should be considered when designing a stormwater management system. Waikato Regional Council recommends that stormwater management systems are located in public spaces (carriageways, drainage reserves, public open spaces) and that they are vested to territorial authorities to ensure that ongoing management of the systems is assured.

11. Floodplains should be preserved. Floodplain encroachment must not be allowed unless competent engineering and planning have proven that flow capacity is maintained, risks of flooding are defined and risks to life and property are strictly minimised. Council recommends that floodplains be preserved to manage flood hazards, preserve habitat and open space, create a more liveable urban environment and protect public health, safety and welfare.

1.3 Best practicable option

A common approach to determining the appropriate standards to be achieved in a consent application process is by consideration of the best practicable option (BPO). Section 108(2)(e) of the Resource Management Act 1991 states that:

“A resource consent may include...a condition requiring the holder to adopt the best practicable option to prevent or minimise any actual or likely adverse effect on the environment of the discharge and other discharges (if any) made by the person from the same site or source”

Generally a BPO approach is considered acceptable when determining a stormwater management system for a proposed development. However there are situations where the sensitivity of the downstream receiving environment or the scale of proposed development necessitates a more determinative approach, i.e. a science based assessment of potential effects and development of a stormwater management system that ensures effects are mitigated accordingly.

Using a BPO approach that is in accordance with design guidance provided in this guideline is recommended. An applicant can propose an alternative approach to site development, however the applicant will be required to demonstrate that a comparable outcome is achieved, relative to the approach recommended in this guideline, in terms of mitigating and avoiding potential adverse effects to the receiving environment.

1.4 How to use this guideline

It is not intended that this guideline be read from cover to cover. It is intended that this guideline is used as a reference document to gain insight and understanding on how to manage stormwater runoff from existing and proposed development.

Part I provides an overview of stormwater management and includes the following sections:

- *Section 1* provides an introduction.
- *Section 2* discusses the impacts of stormwater runoff from urban developments. Refer to this section to understand why stormwater management is necessary.
- *Section 3* provides the Waikato context and outlines the regulatory framework in place in the Waikato Region. Refer to this section to find out what the regulatory documents require in terms of managing stormwater effects. This section also discusses Tangata Whenua perspectives to be considered when designing stormwater management systems.
- *Section 4* outlines the receiving environments in the Waikato Region and summarises the constraints that need to be considered when designing stormwater management systems depending on the receiving environment.
- *Section 5* discusses stormwater management concepts including low impact design and stormwater treatment processes. Refer to this section for insight on approaches to progress development of your site that result in better overall outcomes than more conventional development approaches.

Part II of the guideline covers stormwater design approaches, device design and provides sample design calculations. This part of the guideline includes the following sections:

- *Section 6* discusses factors to be considered when choosing a stormwater management approach.
- *Section 7* presents key design criteria for peak flow control, stormwater quality treatment and stream channel erosion control. This section also discusses how to address climate change predictions in your assessment.
- *Section 8* discusses the individual stormwater management devices and provides methodology on how to design these devices. Case studies are provided.
- *Section 9* discusses outlet design to ensure effective mitigation of potential adverse erosion and scour effects associated with stormwater discharges.
- *Section 10* provides general information on landscaping of stormwater management devices and also provides specific landscape advice for individual devices.
- *Section 11* discusses innovative products and Waikato Regional Council's approach to acceptance of them.
- *Section 12* provides details on how to prepare a contaminant load model for your site to inform the selection of a stormwater management system and to support your consent application.

Part III of the guideline provides discussion about the different site application for stormwater management. This part of the guideline includes the following sections:

- *Section 13* focusses on industrial land use and provides guidance on how to manage stormwater effects from this land use type.
- *Section 14* considers rural residential development and discusses items to be considered when designing stormwater management systems to mitigate potential effects from this land use type.
- *Section 15* discusses Waikato Regional Council's administered drainage areas and constraints to consider when your development interacts with a drainage area.
- *Section 16* discusses retrofitting stormwater management into existing built up areas. This section outlines a possible method that can be followed to consider, prioritise, assess and eventually implement retrofit projects.

Part IV of the guideline discusses construction, operations and maintenance for stormwater management systems, and includes the following:

- *Section 17* discusses construction related issues for stormwater management devices. This section is essential reading for designers (to ensure potential construction issues are addressed as effectively as possible in the design), contractors (to know what to look out for when constructing stormwater management devices), and agencies who the stormwater management assets will vest in (to assist with construction inspections and pre-transfer considerations).
- *Section 18* outlines operation and maintenance requirements for the various stormwater management devices discussed in this guideline. This section will be useful when considering what devices to use in a stormwater management system, or when preparing an operation and maintenance plan for your site. This section will also be useful for those agencies with ongoing responsibility to operate and maintain stormwater management devices.

The *Appendix* contains a glossary of stormwater management terms used in this guideline in *Appendix A*. The low impact design scoring matrix is provided in *Appendix B*. Useful documents relating to the construction and ongoing operation and maintenance of stormwater management devices are included in *Appendix C*. This appendix includes a pre-construction meeting form, device construction forms, as-built document forms and operation and maintenance forms. These forms will be useful for designers, contractors and for agencies with whom the assets will vest.

2 Impacts of stormwater runoff

Urban development in the Waikato Region has had significant impacts on the natural water cycle. Historically the drainage of urban areas focussed on conveying stormwater into receiving waters as quickly as possible. This approach reduced flooding and enabled urban areas to be established and to grow, however it has led to the degradation of natural waterways in our region.

Urbanisation results in the establishment of significant impervious surfaces such as roofs, roads and other hard surfaces that cover the land. These surfaces prevent rainfall from soaking into the ground and cause impacts related to the increased stormwater runoff from those surfaces. Impervious surfaces also convey contaminants efficiently into drainage systems where they are transported to receiving environments.

This section presents the key issues of stormwater quantity, stormwater quality and stream channel stability.

2.1 Hydrological cycle

To better understand the effects associated with stormwater runoff we must first consider the hydrological cycle. The hydrological cycle describes the movement of water in the environment. Catchments are part of a gigantic water circulation network. Powered by the sun, the water cycle moves water between the earth's surface and atmosphere in a continual circuit. The following figure demonstrates the hydrological cycle.

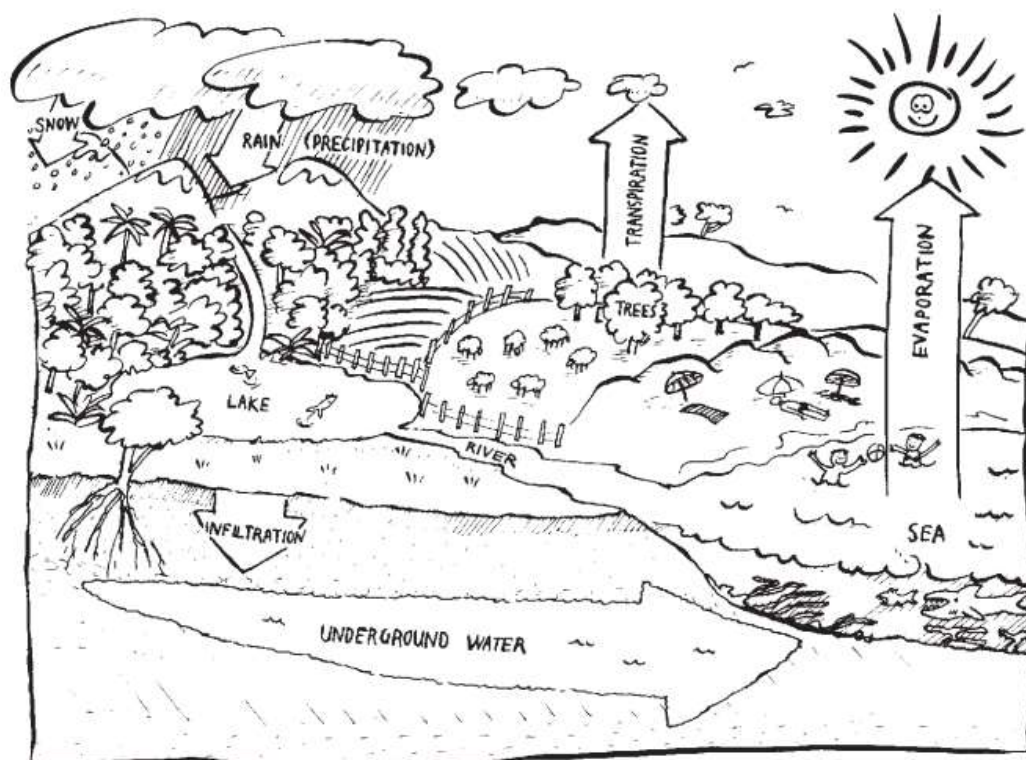

Figure 2-1: Hydrological cycle³

The rate of movement of water through the cycle can be altered dramatically through changes that are made to the land surface. Vegetation and wetlands act like sponges to slow and absorb water during wet times of the year. When vegetation and wetlands are replaced with impervious surfaces (roofs, roading, paving, etc.) less water infiltrates into the ground and more water flows directly into streams through drainage ditches and stormwater drainage pipes. The increased

³ <https://www.waikatoregion.govt.nz/assets/PageFiles/5949/04understanding.pdf>

runoff may cause a variety of problems, including flooding, streambank erosion, sedimentation and pollution.

2.2 Stormwater quantity

Urban development results in the establishment of impervious surfaces that cover the land. These surfaces prevent rainfall from soaking into the ground hence changes the natural hydrological cycle. Urban development can also remove significant amounts of vegetation resulting in reduced plant moisture uptake, evapotranspiration and interception (where a plant's leaves will intercept rainfall and reduce contact with the ground). These processes cause impacts related to the increased stormwater runoff from those surfaces, including:

- Reduced base flow to streams
- Increased flow rates, velocities and volumes of stormwater runoff, which can cause flood effects and can increase erosion of waterways and coastal environments
- Degradation of stream channel physical structure (increases in bank instability, structural constraints (stream crossings, channel reinforcement), incised channels and reduced connectivity with the floodplain). This is discussed further in Section 2.4 below.

Figure 2-2 below illustrates two landscapes; one natural and one with urban development, and shows the natural hydrological cycle for both. In this figure, indicative percentages are provided for the components of the hydrological cycle to enable comparison.

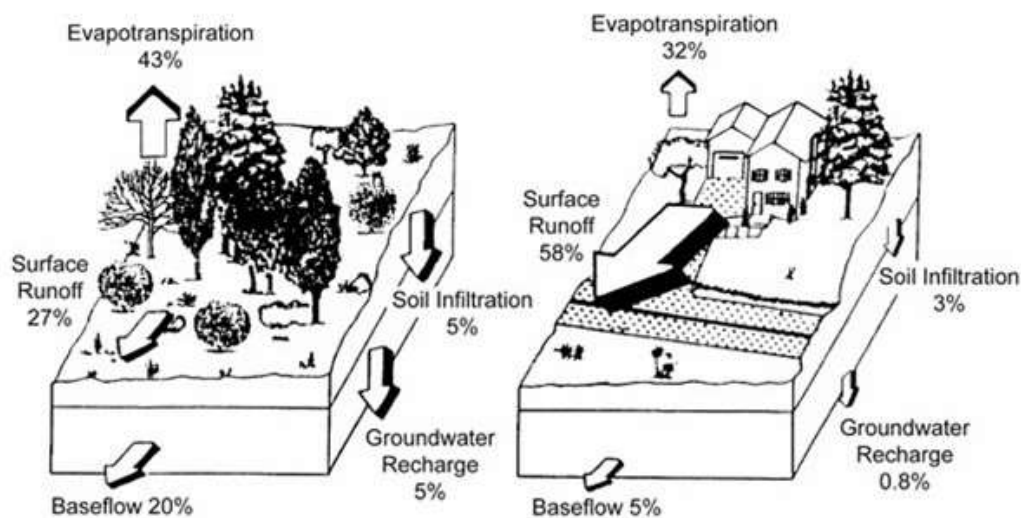

Figure 2-2: Changes in the hydrological cycle as a result of urbanisation⁴

As can be seen from Figure 2-2, when an area is urbanised, surface runoff (stormwater runoff) can more than double, while soakage of stormwater to ground (soil infiltration and groundwater recharge) is reduced. This results in a change in stormwater runoff being released to the receiving environment with potential associated adverse effects.

Figure 2-3 below shows another representation of stormwater quantity impacts associated with urban development. This figure provides stormwater hydrographs for a site before and after development, with the site changing from vegetated land to urban land use.

⁴ Shaver, Low Impact Design Guideline for the Auckland Region, 2000

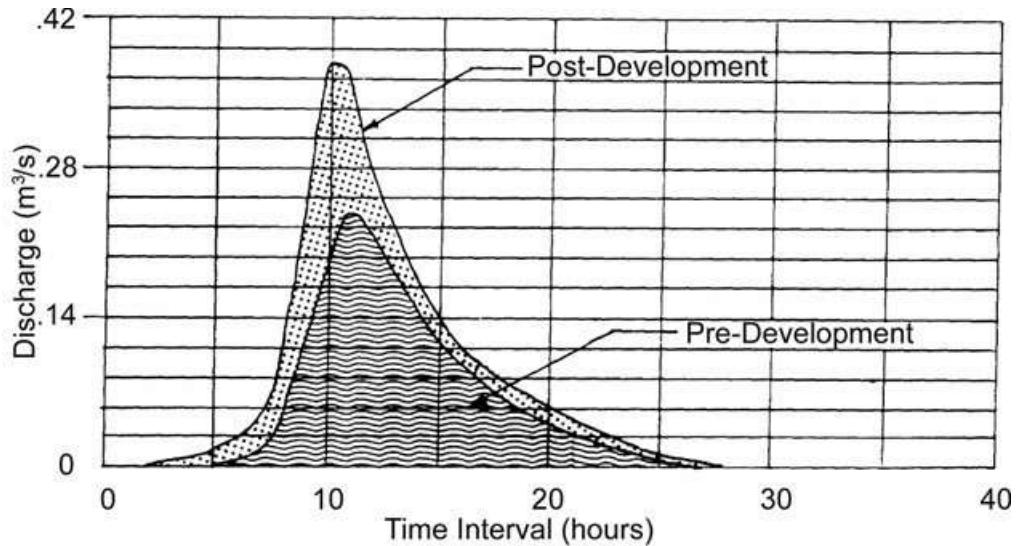

Figure 2-3: Stormwater hydrographs – pre-and post-development

Comparison of the hydrographs demonstrates the following:

- The peak rate of discharge from the site increases post development.
- The total volume of stormwater exiting the site increases post development, and
- The peak rate of discharge of the developed site occurs prior to the discharge from the pre-development site.

All of these items combine to increase the magnitude and frequency of downstream flooding and increasing downstream channel erosion potential.

2.2.1 Flood effects

Generally, stormwater drainage systems are designed for a moderate level of performance and territorial authorities may adopt up to a 10-year Average Recurrence Interval (ARI) event for pipe sizing. However, the importance of more severe, less frequent events is acknowledged and allowance is made for overland flow paths for events up to the 100-year ARI event. These two systems are termed the primary and secondary drainage systems. To protect the public and their property, the Building Act requires that habitable building floor levels have a contingency freeboard above the 50-year ARI flood level.

Flooded house for sale



Flooding adjacent to waterways occurs naturally but urbanisation can increase flood potential due to either a gradual increase in peak flows, or where a constriction in the drainage channel (culvert, pipe drainage system) or stream channel reduces the flow capacity.

Ngarimu Bay, Coromandel flood



The safe passage of flood flows is not always a case of “making the pipes big enough”. Water flow can change with its location along the channel due to changes in topography, channel dimensions, roughness, pools and other factors. The flood level at a given point is therefore determined by how quickly upstream catchments deliver water and how quickly downstream channel and floodplain capacities allow it to get away. The equilibrium sets the flood level. The flow rate also changes with time, as the flood passes down a catchment. The flood level will therefore constantly change as both the physical-spatial factors change and the variation of flow with time balance varies.

The case study below considers the effects of increasing urban land cover on peak flows.

2.2.2 Case study – water quantity effects

Consider a 27.7 hectare site that was previously pasture with two existing houses on it. The site has been developed into 297 lots with average lot size of 600m². For average sized houses, garages, driveways and subdivision roading, the imperviousness increases from less than 1% for the pre-developed scenario to 54% for the developed scenario.

Figure 2-4 shows the pre-development and post-development 2-year and 10-year ARI hydrographs the site.

The hydrographs show that the peak flow rate for the 2-year ARI event increases from 1.51 m³/s to 2.80 m³/s and for the 10-year ARI event increases from 2.7 m³/s to 4.37 m³/s. The volume of stormwater runoff for the 2-year ARI event increases from 10,200 m³ to 16,800 m³.

Stormwater from the development discharges to a stream. The extra peak flow in the watercourse raises the flood level in the stream. The flood level equivalent to the pre-development 2-year ARI event now occurs more frequently, resulting in more frequent bankfull flows. This results in more stream bank erosion. Urbanisation of catchments can result in major flooding and sedimentation problems.

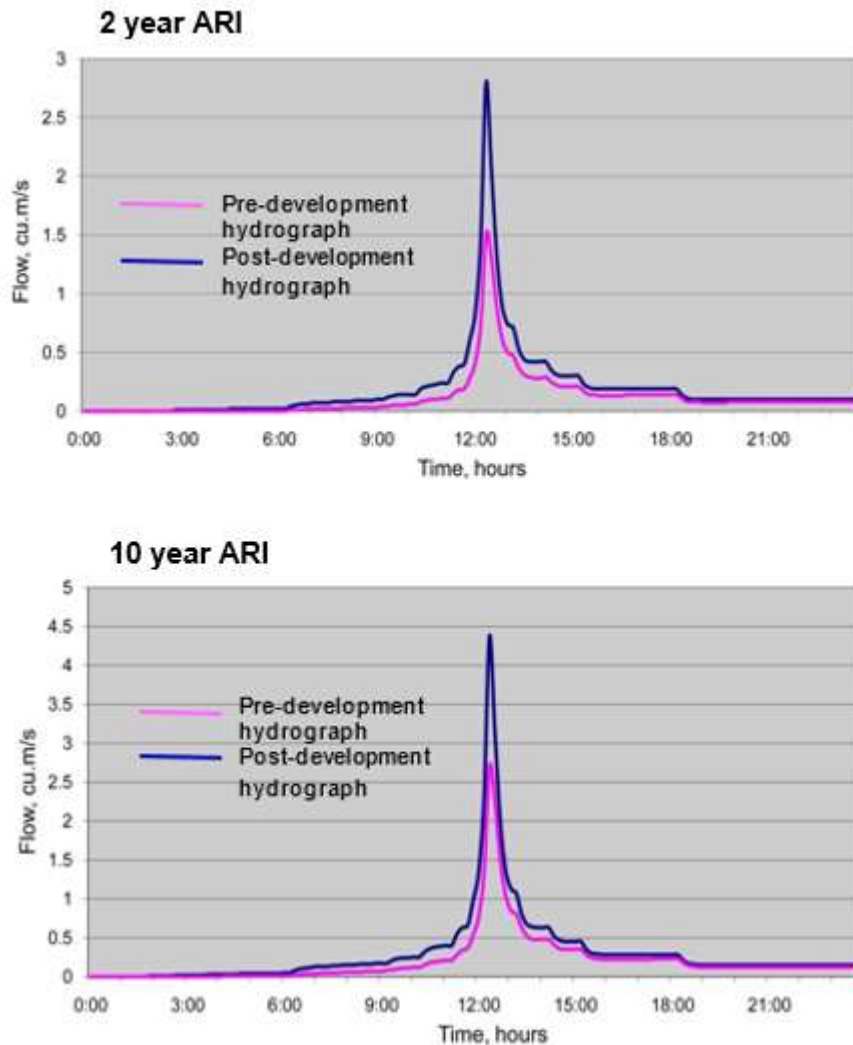

Figure 2-4: Hydrograph comparison for pre and post development scenarios

The more important stormwater quantity effects of urbanisation include the following:

- Complete reticulation of a catchment when urbanised will almost double the mean annual flood return period.
- A fully urbanised catchment, completely reticulated and with approximately 50% impervious cover, will increase the peak discharge of a 2-year ARI event by approximately four times.
- Large floods of low frequency, such as 50-year or 100-year ARI events, show a relatively lesser effect from urbanisation, with their peak flows increasing about 2.5 times.
- The number of bank overflows increases, perhaps doubling where the catchment is 20% storm reticulated and 20% impervious.
- Floods rise to a higher peak more quickly than under previous rural conditions, and also runoff occurs more rapidly.
- Natural baseflow may decrease as a result of reduced groundwater recharge.
- Where channel materials are erodible, the stream channel will tend to enlarge as part of the process of larger and more frequent floods.

2.3 Stormwater quality

When rain contacts the ground and drains downhill, a range of contaminants are entrained in the stormwater depending on the land use type. Urban activities typically increase and

introduce new contaminants when compared to runoff from natural areas, which can cause adverse effects in the receiving environment.

Some of the key pollutants associated with urban stormwater include: sediments, pathogens, total and dissolved metals, hydrocarbons and oil, organics and pesticides, nutrients and gross pollutants.

An additional impact of urbanisation is an increase in water temperature of stormwater runoff from contact with hard stand areas heated by the sun. Thermal effects of stormwater can have a significant adverse effect on aquatic species in downstream receiving environments.

A very simple way to note stormwater effects is to walk along an urban stream and note the changes as the land use changes. Areas with greater levels of imperviousness discharge higher quantities of contaminants and water volumes that quickly change the physical structure and quality of the stream. Effects are particularly evident where the upper reaches of a catchment are undeveloped. A visual survey can document comparative downstream changes, such as channel erosion locations, fish pass blockages and areas of sedimentation.

Measuring contaminant levels in water or sediment and comparing results against accepted threshold values can also indicate effects on organisms. A number of urban runoff studies have been carried out in New Zealand and internationally to monitor water quality effects. There is national and international evidence that catchment development can have dramatic adverse effects on aquatic habitat, diversity and abundance.

2.3.1 Contaminant types

Urban stormwater carries with it a wide variety of contaminants from multiple sources. Representing the majority of recognised classes of water contaminants, these originate not only from land activities in the catchment but can also occur due to atmospheric deposition. In addition, surface and groundwater can exchange. Streams flowing during times with no rain are an indication of the surface groundwater interaction.

Contaminants commonly found in urban stormwater that can harm receiving waters are listed in Table 2-1 below.

Table 2-1: Typical urban stormwater contaminants

Parameter	Description
Suspended sediments	Soil and organic particles entrained in stormwater flows
Oxygen demanding substances	Soil organic matter and plant detritus which reduce the oxygen content of water when they are consumed by bacteria
Pathogens	Pathogens are disease-causing bacteria and viruses, usually derived from sanitary sewers. Faecal coliform and enterococci are often used as indicators of the presence of pathogens
Metals	Can be in particulate or soluble form. Most commonly measured metals of concern are zinc, lead, copper and chromium. Metals are persistent and do not decompose
Hydrocarbons and oils	Generally associated with vehicle or industrial use
Toxic trace organics and organic pesticides	Compounds found in New Zealand waters including polycyclic aromatic hydrocarbons (PAHs) and organo-chlorine pesticides
Nutrients	Usually considered for nitrogen and phosphorus
Gross pollutants	Litter. Has a high visual and amenity impact

Contaminants other than solids and pathogens are associated with being in a solid or in a dissolved state. In stormwater, many contaminants are associated with solids or soil or other natural particulates. This condition differs among the specific contaminants. For example, depending on overall chemical conditions, each metal differs in solubility. For instance, lead is relatively insoluble and will generally be in a particulate form, while zinc may be found in either a particulate or dissolved form. Nutrients phosphorus and nitrogen typically differ substantially

in that phosphorus can be found either in particulate or soluble form while nitrogen is generally found in soluble form only.

Besides these contaminants, other water quality characteristics affect the behaviour and fate of materials in water. These characteristics include:

- Temperature
- pH - an expression of the relative hydrogen ion concentration
- Dissolved oxygen
- Alkalinity - the capacity of a solution to neutralise acid
- Hardness - an expression of the relative concentration of divalent cations, principally calcium and magnesium
- Conductivity - a measure of a water's ability to conduct an electrical current as a result of its total content of dissolved substances (often expressed as salinity in estuarine and marine waters or total dissolved solids).

These characteristics affect contaminant behaviour in several ways. Metals generally become more soluble as pH drops below neutral and hence become more available to harm organisms. In addition, pH also affects the toxicity of some metals and ammonia.

Depleted dissolved oxygen can also increase metals solubility. Anaerobic conditions in the bottom of lakes release phosphorus from sediments, as iron changes from the ferric to the ferrous form.

Elements creating hardness reduce toxicity of many heavy metals. Water quality analyses account for this by varying the allowable level as a function of hardness.

2.3.2 Contaminant sources

Table 2-2 provides discussion of where stormwater contaminants originate in the urban environment.

Table 2-2: Sources of urban stormwater contaminants⁵

Parameter	Source
Atmospheric deposition	From urban and rural areas: fine particles, phosphorus, ammonia, nitrate, metals, pesticides, petroleum products, toxic organics and metals
Litter and leaf fall	Personal and commercial debris discarded to roadways and parking lots such as plastics, paper, cans, and food; leaves and organic debris from roadside and parking lot trees; BOD, nitrogen, phosphorus, humic organics, metals
Residential and roadside landscape maintenance	Phosphorus and nitrogen, pesticides and herbicides, dissolved organics from soil amendments
Urban wildlife and pets	Bacteria, phosphorus and nitrogen
Transportation vehicles	Fuels, brake drum and tire wear, body rust, fine particles, metals in particular zinc, copper, cadmium, lead, and chromium; and petroleum products such as oil/grease and PAH
Pavement and pavement maintenance	Temperature modification, petroleum derivatives from asphalt
Pavement de-icing	Chlorides, sulphates, organics from acetate de-icers, coarse sediments, and cyanide
Building exteriors	Galvanised metals, chipped and eroded paints, corrosion of surfaces accelerated by acid rain, metals. Various roof materials have the potential to release contaminants including Zinalume,

⁵ Minton, 2002

Parameter	Source
	coated iron, copper, bitumen, decramastic and factory painted steel products.
Industrial businesses	Varies widely with the industry. Includes the contaminants commonly contributed by other sources but may also include those less commonly detected in general urban runoff or at concentrations greater than normally found in contaminants from inappropriate connections, petroleum products, phenols, solvents, metals.
Commercial businesses	Parked vehicles, improperly disposed refuse such as discarded food, used cooking oil and grease, and packaging materials, internal drains improperly connected to the stormwater system, metals, BOD, bacteria, phosphorus, nitrogen, oil and grease
Residential activities	Landscaping, pest control, moss control, vehicle maintenance, painting, wood preservation, pesticides and herbicides, phosphorus, nitrogen, petroleum products, zinc and bacteria
Site development	High pH from fresh concrete surfaces, petroleum products from fresh asphalt and spills, organics and particles from landscaping materials, eroded sediment and associated constituents such as phosphorus, contaminants associated with improperly disposed construction materials like fresh concrete and paints, cement from preparation of exposed aggregate concrete
Public infrastructure	Metals from galvanised stormwater drain systems, metals and petroleum products from maintenance shops, bacteria, nitrogen, phosphorus and organics from exfiltration or overflowing sanitary sewer

There are a number of statements that can be made regarding water quality:

- The impact of stormwater on the aquatic environment is due to three factors: a large increase in the volume of water that runs off impervious surfaces compared with more absorbent vegetated surface land uses; the greatly accelerated rate of runoff; and contamination of stormwater with a wide range of substances.
- Contaminants are collected by runoff from a variety of diffuse and point sources within a wide catchment area but are often concentrated by reticulated collection system at outfalls into aquatic receiving environments.
- The contaminants of most concern are suspended solids, a range of heavy metals, organochlorines, polycyclic aromatic hydrocarbons (PAHs), nutrients and human pathogens. Sources typically are widespread throughout the urban catchment and are classified as diffuse sources.
- Many sources of stormwater contamination are difficult to control because of their diffuse distribution catchment-wide.
- Discrete sources of stormwater contaminants increase in industrial areas through yard and equipment washing and accidental or deliberate discharge of products and wastes from industrial processes that allow contaminants to enter the stormwater system.
- Depending on the contaminant, many contaminants are bound to particulate matter in stormwater. A high proportion of these suspended solids pass through the drainage

Stormwater discharge into a stream



channels and eventually reach the marine receiving environment. In the marine receiving environment, suspended solids are then incorporated into marine sediments.

- Other settling processes also occur when contaminants move from freshwater to estuarine or saline waters.
- Settling occurs least along open coasts and harbour entrances due to their being high energy environments. Most sedimentation occurs in upper estuaries where flow velocities are reduced and salt tends to flocculate finer particles. The headwaters of most estuaries are poorly flushed because much of the water draining on the ebb tide returns on the following flood tide. In contrast, open coastal regions are well flushed by tides and contaminants can be re-mobilised into the water column by wave, current and tidal action and are widely dispersed.
- Upper estuaries are therefore regarded as highly sensitive to stormwater contamination, because they act as retention zones where suspended solids are deposited, and where contaminants continually accumulate. There is a higher rate of build-up of contaminants near stormwater outfalls. Concentrations then decrease with increasing distance from individual stormwater outfalls.
- Urban stormwater in New Zealand has similar concentrations and types of contaminants to those found in other developed countries.
- In urban streams, acute and chronic toxicity water quality criteria for the protection of sensitive biological species are regularly exceeded for heavy metal contaminants. Organic contaminant levels in stormwater may sometimes exceed the relevant chronic water quality criteria but the New Zealand information base is sparse. Further downstream where urban streams discharge into larger water bodies, water quality criteria are predicted to be rarely exceeded because of dilution and settling of particulates, which carry most of the contaminants.
- The impacts of land development on small urban streams have been severe. Many impacts are caused by modifications to channel and riparian areas, as well as by the hydrological changes accompanying urbanisation.
- In sheltered coastal sediments, there is a clear link between urban stormwater contamination and build-up of contaminants. There is strong evidence that this build-up is detrimental to species living in the sediment and which provide the basis of the estuarine ecosystem. Sediment contaminant concentrations in some urban estuaries and harbours exceed North American sediment quality criteria, and there is evidence of chronic toxic effects to species in urban waters.
- In streams and near stormwater outfalls, many contaminants regularly exceed sediment quality criteria for the protection of sediment-dwelling species. Many of the retention zones of estuaries with significantly urbanised catchments exceed the criteria for lead, zinc, copper and organochlorines.
- If contaminant generation continues at present day rates, the rate of sediment contamination will accelerate with urban expansion, and the extent of the affected areas will increase.

2.3.3 First flush

Managing water quality also requires an understanding of the “first flush” event where the initial runoff from a surface contains (by volume) the highest proportion of contaminant load compared to runoff in the remainder of the storm. The first flush is generally characterised by a peak in some pollutant loads (such as sediments and metals) immediately prior to the peak in flow volumes.

Best practice for water quality improvement promotes the capture and treatment of **at least** the first flush event, as this is often more practical and cost effective than treating flow volumes from the entire storm event.

2.4 Stream morphology and aquatic resource

Stream channel physical structure is another issue that is adversely impacted by catchment development. The creation of impervious surfaces reduces the amount of soakage that can occur in a given area thus increasing the amount of stormwater runoff for a given storm.

An example of this increase is the initial abstraction depth that wets and fills lower areas prior to runoff initiation. On a pervious surface, it may take a significant amount of rainfall before any runoff initiates. On impervious surfaces, that number is essentially zero.⁶ There may be some wetting of the impervious surface but runoff initiates soon after the wetting. As catchment imperviousness increases there is a shift in the frequency of storm generated stream flows and the amount of subsequent work that is undertaken on stream physical structure.

A study undertaken on stream erosion in the Auckland Region⁷ predicts a three-fold increase in stream channel cross-section when a catchment goes from pastoral to urban land use.

Where bankfull stream discharge in a rural catchment may occur once every 1.5 - 2 years, urban streams can flow at full stage a number of times a year. Less rainfall generates more runoff, which increases the amount of work undertaken on stream channel boundaries.

To consider this visually, Figure 2-5 shows the stages of a stream cross-section when going from a bush covered catchment, to a modified catchment, to a fully urbanised catchment.

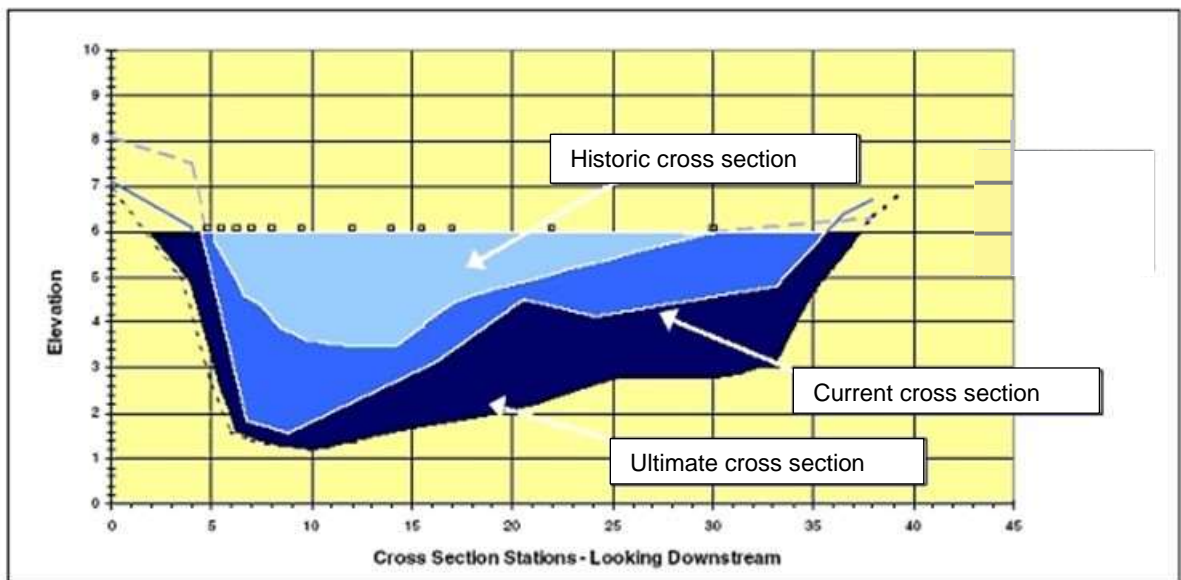

Figure 2-5: Effects of urbanisation on stream cross section⁸

This figure illustrates the altered channel structure that can result as a stream catchment is urbanised.

The physical appearance and function of a stream's boundaries, generally called stream morphology, is a product of the magnitude of stream flow and erosional debris produced by a catchment. The influence of channel materials, catchment slope and other features of catchment morphology further modify individual stream characteristics. As the catchment area increases so do the requirements of the stream to convey water and sediment.

2.4.1 Bankfull discharge

A common term used in stream morphology is "bankfull" flow. This is a term that is used to denote channel capacity. When bankfull flow is exceeded, floodplain flow initiates.

⁶ Waikato Regional Council, 2020

⁷ New Zealand Herald article, 1989

⁸ Center for Watershed Protection, 2003.

Stream dimensions, patterns and bed features are a function of channel width measures at bankfull stage. The bankfull stage corresponds to the discharge at which channel maintenance is most effective, i.e. the discharge at which moving sediment, forming or removing bars, forming or changing bends and meanders and generally doing work that results in the average morphologic characteristics of channels.

Typical velocity distributions are shown in Figure 2-6 below. It is this discharge in combination with the range of flows that make up an annual hydrograph which govern the shape and size of the channel. Bankfull discharge is associated with a momentary maximum flow that on the average has a recurrence interval of 1.5 - 2 years as determined using a flood frequency analysis.

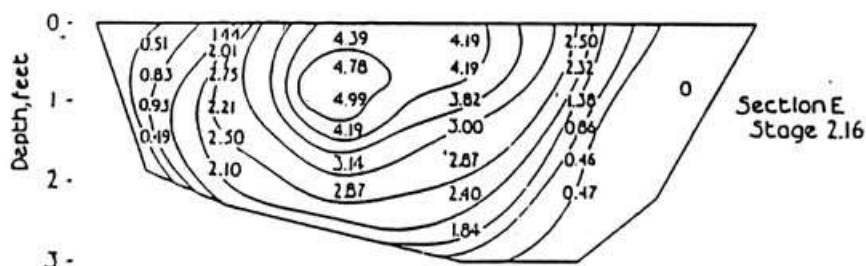

Figure 2-6: Stream cross section showing velocity distributions⁹

2.4.2 Stream channel dimensions

Stream width is a function of stream flow occurrence and magnitude, size and type of transported sediment and the bed and bank materials of the channel. Channel width is influenced by the following:

- Direct channel disturbance such as channelization
- Changes in riparian vegetation that may alter boundary resistance and increase channel erosion potential, and
- Changes in streamflow regime due to catchment changes such as increased impervious surfaces or increased sediment delivery resulting from construction.

2.4.3 Stream channel patterns

Un-modified streams are rarely straight for any substantial distance rather they tend to follow a sinuous course. Meander geometry is most often expressed as a function of bankfull width.

An example of the relationships that exist and the various components of a meander pattern are shown in Figure 2-7. The parameters include bankfull width, meander wavelength and radius of curvature.

Stream flow regimes not only include bankfull channel widths but can also change stream patterns, depending on the magnitude and duration of flows. As catchments are urbanised, widening of streams and changes in channel patterns can be observed. These channel adjustments are brought on by an acceleration of streambank and bed erosion.

⁹ Chow, 1959

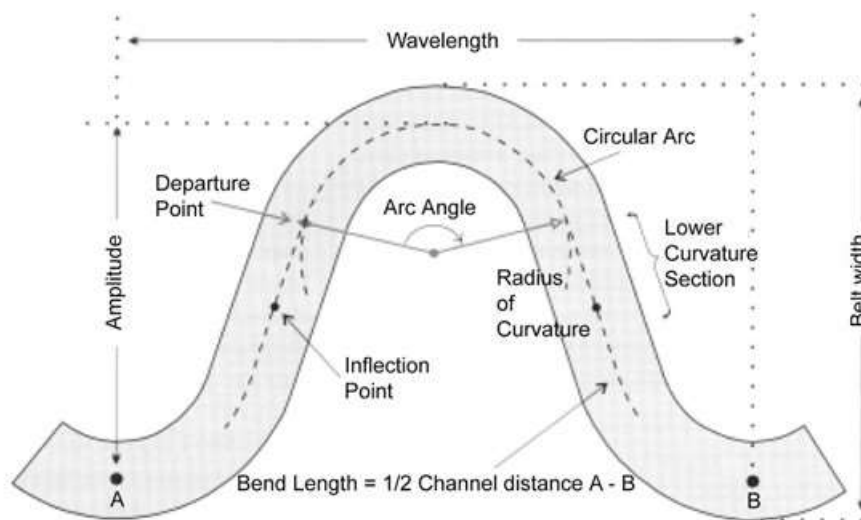

Figure 2-7: Stream channel geometry¹⁰

The patterns of streams are naturally developed to provide for the dissipation of the kinetic energy of moving water and the transport of sediment. The meander geometry and associated riffles and pools adjust in such a way that the work expended on natural processes is minimised.

Consequently, straightening stream channels ultimately leads to a state of disequilibrium or instability, often causing entrenchment and changes in morphology and stability.

Example of a natural stream meander pattern



Over the last 150 years, numerous streams have been straightened under the assumption that their functional efficiency would increase.

The meander patterns that streams exhibit result in maintaining a slope such that the stream neither degrades nor aggrades, as the meanders increase stream length, therefore reducing channel slope and reducing velocity. Reducing the natural meander changes the alignment of the stream, local stream reach slopes are changed and instability may result.

2.4.4 Stream channel profile

Generally channel gradient (or slope) decreases in a downstream direction with increases in stream flow. The shape of a longitudinal profile of a first or second order stream at the top of the catchment to the lower part of the catchment is generally concave. Since steep gradient streams are relatively straight, they dissipate energy along the longitudinal profile in relatively close spaced features, normally called riffles and pools. Their spacing is inversely related to slope and proportional to the bankfull width.

2.4.5 Stream ecology

Water in streams only moves in one direction (downhill) hence there is a constant loss of organisms and materials to the sea. The stream community is entirely dependent on materials entering the system from mostly terrestrial ecosystems, typically as particulate matter (leaves,

¹⁰ Rosgen, 1996

organic and inorganic matter). As a result, different streams and reaches of streams have different aquatic communities. Upland fast-flowing streams with stony beds differ in community structure from slow-flowing lowland rivers with muddy bottoms.

Looking at what lives in a stream in an undisturbed forested condition and relating that to what commonly exists in a stream that is impacted by urban development can provide a barometer of what we can expect if development was to occur in a traditional manner.

A discussion of ecological issues also can provide guidance of what site resources are important to maintain if aquatic ecosystem protection is a goal.

The dynamic nature of wet-weather flow regimes and water quality make it difficult to assess the impact of urbanisation and stormwater on aquatic ecosystems. Physical habitat and biological measures reflect aquatic ecosystem conditions over months and years and thus integrate these variable conditions into a more easily understood set of measures. Physical habitat is a principal element of ecological analysis. Without the proper channel and riparian characteristics (floodplain, shade, stable channel, riffles, pools, etc.) improvements in hydrology and water quality will demonstrate little change in ecosystem function or value. Most importantly, the aquatic community (plants, invertebrates, fish) provides a direct measure of ecosystem quality and sustainability.

Table 2-3 provides a summary of the impacts of urbanisation on aquatic ecosystems.

Table 2-3: Impacts of urbanisation on aquatic ecosystems¹¹

Environmental concern	Potential impact	Cause-source
Increase in runoff driven peak or bankfull stream flows	Degradation of aquatic habitat and/or loss of sensitive species	Increased stormwater runoff volume due to an increase in catchment imperviousness
Increase in runoff –driven flooding frequency and duration	Degradation of aquatic habitat and/or loss of sensitive species	Increased stormwater runoff volume due to an increase in catchment imperviousness
Increase in wetland water level fluctuations	Degradation of aquatic habitat and/or loss of sensitive species	Increased stormwater runoff due to an increase in catchment imperviousness
Decrease in dry season baseflows	Reduced aquatic habitat and less water for human consumption, irrigation or recreational use	Water withdrawals and/or less natural infiltration due to an increase in catchment imperviousness
Streambank erosion and stream channel enlargement	Degradation of aquatic habitat and increased fine sediment production	Increase in stormwater runoff driven stream flow due to an increase in catchment imperviousness
Stream channel modification due to hydrologic changes and human alteration	Degradation of aquatic habitat and increased fine sediment production	Increase in stormwater runoff driven stream flow and/or channel alterations such as stopbanks
Streambed scour and incision	Degradation of aquatic habitat and loss of benthic organisms due to washout	Increase in stormwater runoff driven stream flow due to an increase in catchment imperviousness
Excessive turbidity	Degradation of aquatic habitat and/or loss of sensitive species due to physiological and/or behavioural interference	Increase in stormwater runoff driven stream flow and subsequent streambank erosion due to an increase in catchment imperviousness

¹¹ Shaver et al, 2007

Environmental concern	Potential impact	Cause-source
Fine sediment deposition	Degradation of aquatic habitat and loss of benthic organisms due to fine sediment smothering	Increase in stormwater runoff driven stream flow and subsequent streambank erosion due to an increase in catchment imperviousness
Sediment contamination	Degradation of aquatic habitat and/or loss of sensitive benthic species	Stormwater runoff contaminants
Loss of riparian integrity	Degradation of riparian habitat quality and quantity, as well as riparian corridor fragmentation	Human development encroachment and stream road crossings
Proliferation of exotic and invasive species	Displacement of natural species and degradation of aquatic habitat	Encroachment of urban development
Elevated water temperature	Lethal and non-lethal stress to aquatic organisms – reduced DO levels	Loss of riparian forest shade and direct runoff of high temperature stormwater from impervious surfaces
Low dissolved oxygen (DO) levels	Lethal and non-lethal stress on aquatic organisms	Stormwater runoff containing fertilisers and wastewater treatment system effluent
Lake and estuary nutrient eutrophication	Degradation of aquatic habitat and low DO levels	Stormwater runoff containing fertilisers and wastewater treatment system effluent
Bacterial contamination	Human health (contact recreation and drinking water) concerns, increases in diseases to aquatic organisms and degradation of shellfish harvest beds	Stormwater runoff containing livestock manure, pet waste and wastewater treatment effluent
Toxic chemical water contamination	Human health (contact recreation and drinking water) concerns, as well as bioaccumulation and toxicity to aquatic organisms	Stormwater runoff containing toxic metals, pesticides, herbicides and industrial chemical contaminants
Reduced organic matter and large woody debris	Degradation of aquatic habitat and loss of sensitive species	Loss or degradation of riparian forest and floodplain due to development encroachment
Decline in aquatic plant diversity	Alteration of natural food web structure and function	Cumulative impacts of urbanisation
Decline in aquatic invertebrate diversity	Alteration of natural food web structure and function	Cumulative impacts of urbanisation
Decline in amphibian diversity	Loss of ecologically important species	Cumulative impacts of urbanisation
Decline in fish diversity and abundance	Loss of ecologically important species	Cumulative impacts of urbanisation

2.4.6 Physical habitat

The increased frequency and magnitude of peak flows destabilises stream banks and increases sedimentation. Sedimentation can smother stable and productive aquatic habitats such as rocks, logs and aquatic plants. The roots of large trees are undercut and trees fall into the stream while new growth has less opportunity to become established. Bare soil stream banks also result from deliberate removal of vegetation and are a common feature of urban streams.

Stream erosion with bank being undercut



The direct removal of trees and shrubs as part of urban development accelerates the loss of stable riparian vegetation. The resulting stream ecosystem is in a constant state of instability with little opportunity to become stable and more complex.

Ecosystem function and quality increases with increased complexity, and the more complex the habitat, the more complex the ecosystem functions. Forests are more complex ecosystems than pastures.

2.4.7 Ecological stress factors

The main factors influencing plants and animals in streams include the following:

- Physical habitat
- Temperature
- Dissolved oxygen
- Contaminants (including suspended solids, nutrients, metals, hydrocarbons and oils and pesticides)
- Stream flow
- Light
- Instream barriers, and
- Clearance of riparian vegetation.

Urbanisation results in impacts related to all of the above items. No one single item is of primary importance. If impacts to aquatic ecosystems are to be minimised, approaches must address all of the above items. Thus, the council's recommended approach to stormwater management attempts to reduce the impacts associated with each item.

Figure 2-8 below relates imperviousness of a catchment to stream health. In this figure stream health is represented by presence of sensitive aquatic macroinvertebrate (Ephemeroptera Plecoptera Trichoptera or EPT) and the horizontal axis relates to percentages of impervious surface in a given catchment. Imperviousness is an imperfect surrogate but it does incorporate many of the factors listed above.

Figure 2-8 shows that increased levels of imperviousness adversely affect the survivability of sensitive aquatic species as imperviousness increases. Once urbanisation is completed, the macroinvertebrate community generally consists of worms and midges, which indicates a degraded stream condition.

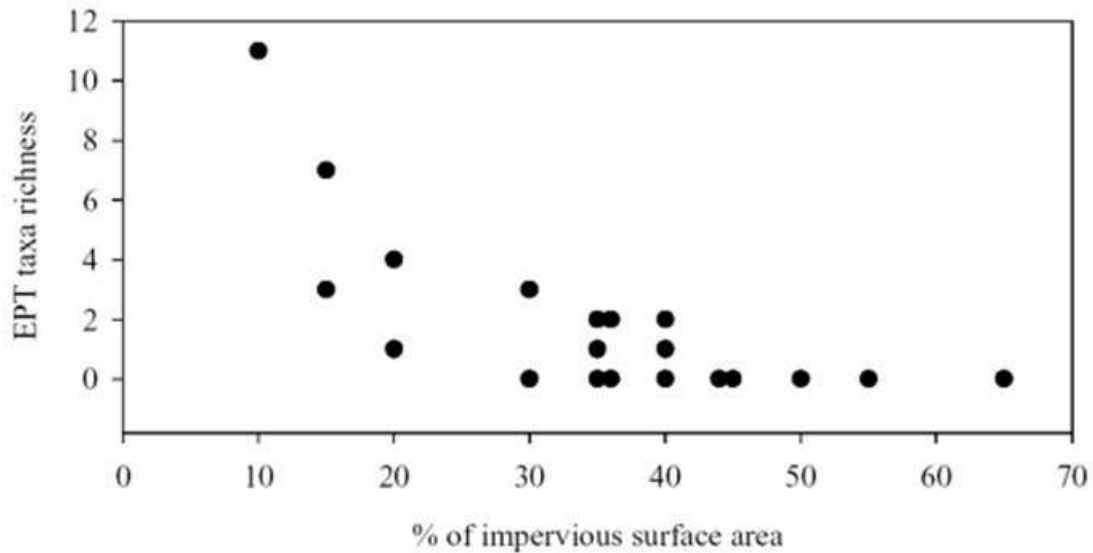

Figure 2-8: Sensitive aquatic organisms versus impervious surface percentages¹²

2.4.8 Importance of first and second order streams

When considering aquatic resource protection, it is important to consider the entire catchment and to recognise that all streams, regardless of how small, are integral components of the whole system. To understand the relative importance of each part it is helpful to classify streams in terms of their 'order'. Stream order is based upon smaller streams draining into larger ones. First order streams are catchment headwater streams. They are generally the smallest streams and flow can be perennial or ephemeral. Second order streams are those formed by the junction of two first order streams. The junction of two second order streams forms a third order stream. A schematic representation of stream order is shown in Figure 2-9 below.

More recently, the term 'zero' order streams, or 'non-perennial' streams has been used to indicate streams that may not have base-flow throughout the year but have saturated channel soils. These streams have biological values that add additional biodiversity to perennial streams.

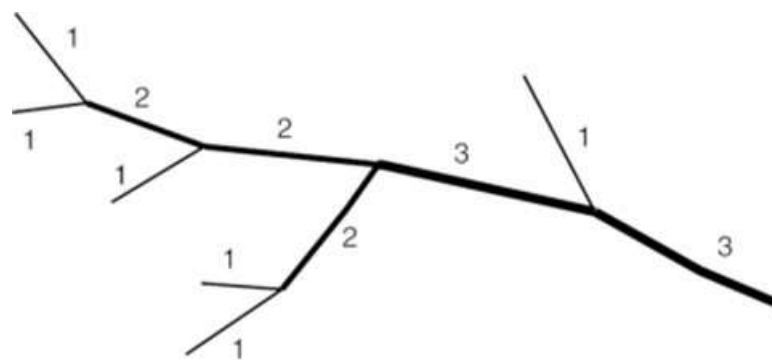

Figure 2-9: Conceptualisation of a stream hierarchy¹³

The following table provides specific information about streams and rivers in the Waikato Region, including their order and percentage of total length.

¹² Allibone et al, 2001

¹³ Parkyn et al, 2006

Table 2-4: Order of streams and rivers in the Waikato Region¹⁴

Stream Order	Length (m)	Length in % of total length
1	26,718,000	62
2	7,879,637	18
3	4,486,129	10
4	2,336,487	5
5	1,181,286	3
6	522,597	1
7	435,126	1
Total	43,559,262	100

It is important to recognise that over 60% of the streams in the Waikato Region are first order streams (in terms of total length). When combined with second order streams, that total increases to 80% of all streams.

A similar review of streams in the United States indicates that approximately 70% of all streams are first and second order streams.

If it is a programme goal to protect third order or larger streams, that goal cannot be attained if first and second order streams are destroyed by mass earthworks or enclosed in pipes.

A study¹⁵ assessed the effectiveness of structural devices for protection of stream aquatic resources from a catchment-wide perspective and made the following key findings:

- Until catchment total impervious area exceeds 40% biological decline was more strongly associated with hydrologic fluctuation than with chemical water and sediment quality decreases.
- Structural stormwater management devices at current densities of implementation demonstrated less potential than the non-structural methods (riparian buffers, vegetation preservation) to forestall resource decline as urbanisation starts and progresses. Analysis showed that none of the stormwater management options are without limitations and widespread landscape preservation must be incorporated to retain the most biologically productive aquatic resources.
- Structural stormwater management devices can make a substantial contribution to keeping stream ecosystem health from falling to the lowest levels at moderately high urbanisation and, with extensive landscape preservation, to maintaining relatively high biotic integrity at light urbanisation.

A major reason this guideline stresses the importance of combining conventional stormwater management with low impact design is that the volume of stormwater generated must be reduced if aquatic resource protection is to be provided. Just providing mitigation for urban development will only reduce the rate of decline.

The combination of low impact design in conjunction with conventional stormwater management provides the best opportunity to ensure receiving environments in the Waikato are protected and restored and enhanced in accordance with the Regional Policy Statement.

This guideline recommends the protection of first and second order streams. Piping natural water courses is not supported.

¹⁴ Waikato Regional Council, LINZ 1:50,000 topographic scale

¹⁵ Horner, 1999

2.5 Cumulative effects

From a catchment perspective, the water quality and quantity effects of stormwater runoff from an individual site may be relatively minor. If we consider a 10% increase in peak flow from one individual site, downstream flood levels may only increase 10mm. However, a 10mm increase in flood level for many sites across a catchment combined is likely to cause a significant increase in flood level that could result in flood damage to properties.

Therefore, in addition to any site-specific effects, cumulative effects must also be considered for the maximum probable development scenario within the catchment.

3 Waikato context

3.1 The Waikato Region

The Waikato is the fourth largest region in New Zealand, covering 25,000 square kilometres (land and water). It stretches from the Bombay Hills and Port Waikato in the north to the Kaimai Ranges and Mt Ruapehu in the south, and from Mokau on the West Coast to the Coromandel Peninsula in the east.

The Waikato Region has one city (Hamilton) and ten districts. At the time of the last census in 2013, 403,638 people lived in the Waikato Region, about three quarters of them in urban areas. The Waikato Region has about 9.5% of New Zealand's population.

The Waikato Region contains:

- The longest river in New Zealand (the Waikato River)
- The largest lake (Lake Taupo)
- Internationally significant wetlands
- The country's most important geothermal systems
- Extensive native and exotic forests, and
- Tongariro National Park.

The Waikato Region has a mean annual rainfall of 1,342 mm, which puts it in the temperate rainforest category.

The region supports over 35,000 km of streams and rivers¹⁶. Rivers in the Waikato Region are mainly alluvial, which means they flow through flood plains they have created by depositing sediment. The Waikato River is 425 km long and begins on Mount Ruapehu, flowing from Lake Taupō across the Volcanic Plateau, into the Waikato basin and out to the Tasman Sea. Its major tributary, the Waipā River, rises in the Rangitoto Range in the King Country. The two rivers converge at Ngāruawāhia.

The Thames Valley and Hauraki Plains areas are drained by the Waihou River, which flows from the Mamaku and Pātetere plateaus; the Piako River, which rises near Maungakawa; and the Waitoa River, which has its source in hill country near Piarere.¹⁷

Wetlands, peat lakes and peat bogs abound in the Waikato lowlands, particularly in the central Thames Valley, north of Taupiri and south of Hamilton. Drainage works to lower the groundwater levels and create farmland have destroyed some wetlands and split others into fragments. However, in the early 2000s the Waikato Region still contained around 30% of New Zealand's wetlands, including the Whangamarino Wetland and Kopuatai Peat Dome.²

Waikato Regional Council monitors changes in the amount of freshwater wetland vegetation using information from satellite data and also has a Regional Indigenous Vegetation Inventory that provides an estimate of historic wetland vegetation (1840). This information shows that:

- Before European settlement freshwater wetlands covered approximately 1,100 km² or 5% of the region, and
- Today approximately 280 km² or 1% of the region is in wetland vegetation.

There are approximately 103 natural 'named' lakes in the Waikato Region plus five hydro-power lakes.¹⁸

The region has abundant aquatic resources that are vulnerable to degradation from both rural and urban land uses unless appropriately managed.

¹⁶ Collier et al, 2010.

¹⁷ Te Ara The Encyclopedia of New Zealand. (Online version <https://teara.govt.nz/en> 2017)

¹⁸ Wildlands Consultants, 2009

3.2 Regulatory framework

The Waikato Regional Council has a number of statutory plans and policies that provide the framework to manage the region's natural resources and that support the formation of the Waikato Stormwater Management Guideline. The Te Ture Whaimana o Te Awa o Waikato – the Vision and Strategy is the prevailing document and is embedded within the Waikato Regional Policy Statement (WRPS). The Te Ture Whaimana o Te Awa o Waikato covers the Waikato and Waipa Rivers and their catchments. The entire Waikato Region and the remainder of the catchments not captured under the Te Ture Whaimana o Te Awa o Waikato are covered by the Waikato Regional Plan (WRP) which must give effect to the WRPS, which in turn must give effect to the National Policy Statement for Freshwater Management (NPS-FM).

3.2.1 The Vision and Strategy

Te Ture Whaimana o Te Awa o Waikato – the Vision and Strategy for the Waikato River (the Vision and Strategy) is the primary direction-setting document for the Waikato River and its catchments. There are three River Acts which establish co-governance arrangements for the Waikato and Waipa Rivers, including the Vision and Strategy. These are Waikato-Tainui Raupatu Claims (Waikato River) Settlement Act 2001, Ngati Tuwharetoa, Raukawa, and Te Arawa River Iwi Waikato River Act 2010 and Nga Wai o Maniapoto (Waipa River) Act 2012. As stated previously, the Vision and Strategy prevails in the case of any inconsistencies in a national policy statement or New Zealand coastal policy statement, and is deemed to be part of the Waikato Regional Policy Statement (WRPS).

Although the Waikato and Waipā Rivers do not represent the whole catchment within the Waikato Region, they do represent a significant proportion of it. The approach contained in Te Ture Whaimana includes the following objectives that support the purpose of the Waikato Stormwater Management Guideline:

- The restoration and protection of the health and wellbeing of the Waikato River.
- The adoption of a precautionary approach towards decisions that may result in significant adverse effects on the Waikato River.
- The recognition and avoidance of adverse cumulative effects, and potential cumulative effects, of activities undertaken both on the Waikato River and within its catchments on the health and wellbeing of the Waikato River.
- The recognition that the Waikato River is degraded and should not be required to absorb further degradation as a result of human activities.
- The restoration of water quality within the Waikato River so that it is safe for people to swim in and take food from over its entire length.

The Waikato Stormwater Management Guidelines represent the latest expertise in the management of stormwater and is a significant step towards achieving Te Ture Whaimana. The document's strategies reference the need to:

- Develop and share local, national and international expertise, including indigenous expertise, on rivers and activities within their catchments that may be applied to the restoration and protection of the health and wellbeing of the Waikato River.

3.2.2 Waikato Regional Policy Statement¹⁹

The purpose of the WRPS is to achieve the purpose of the RMA by providing an overview of the resource management issues of the region, and policies and methods to achieve integrated management of the natural and physical resources. The Vision and Strategy, in its entirety, is deemed to be part of the WRPS and prevails over the WRPS if there is any inconsistency.²⁰

¹⁹ <http://www.waikatoregion.govt.nz/PageFiles/6777/2016/WaikatoRegionalPolicyStatement2016.pdf>

²⁰ Waikato-Tainui Raupatu Claims (Waikato River) Settlement Act 2010, s11

A number of the issues identified in Section 1 of the WRPS support the introduction of a step change in the management of stormwater. These issues note the importance of addressing declining water quality by:

- Restoring and protecting the health and wellbeing of the Waikato and Waipa Rivers.
- Addressing the effects of sedimentation and nutrients in estuaries and harbours that are not derived from natural processes.
- Protecting domestic and municipal water supply sources from the adverse effects of land use.

3.2.3 Relevant WRPS Policy Provisions

The WRPS addresses non-point source discharges (such as agricultural or stormwater run-off) through a range of methods and overarching policy guidance. These can be summarised as follows:

- Policy 6.1 makes provision for planned and coordinated subdivision, use and development. The implementation methods associated with this policy include:
 - The requirement for district plan zoning for new urban development (and redevelopment), subdivision and consent decisions to be supported by information which identifies how stormwater will be managed having regard to a total catchment management approach and low impact design methods.
- Policy 6.2 provides for planning for development in the coastal environment, particularly ensuring that development of the built environment results in the provision of adequate stormwater services.
- Section 6A outlines general development principles, with the expectation that new development should:
 - Avoid as far as practicable adverse effects on natural hydrological characteristics and processes (including aquifer recharge and flooding patterns), soil stability, water quality and aquatic ecosystems including through methods such as low impact urban design and development (LIUDD).
 - Adopt sustainable design technologies, such as the incorporation of rain gardens, rainwater harvesting and grey water recycling techniques where appropriate.
- Policy 7.2 addresses the management of discharges to marine waters. Its implementation methods include seeking that local authorities promote and support initiatives to improve marine water quality (including diffuse discharges and discharges of stormwater and wastewater) such that adverse effects on marine water quality are lessened. These initiatives could include the development and implementation of best practice guidelines and industry standards.
- Policy 8.3 seeks to maintain or enhance water quality by reducing sediment that is derived from human based activities and by reducing microbial, nutrient and other identified contaminants. A range of implementation methods support the policy including those which require regional plans to control point source discharges of contaminants. The implementation methods associated with this policy include:
 - The requirement for the regional plan to manage the adverse effects of activities in riparian areas, including ensuring reduced sedimentation of fresh water bodies.
 - Management of the adverse effects of land use and activities on fresh water bodies from non-point source discharges of nutrients and other contaminants.
 - Promotion of land-based mitigation of stormwater, including the use of wetlands and low-impact options.

- The requirement for territorial authorities to manage the effects of subdivision, use and development either by promoting best practice stormwater management for urban areas, including the need for stormwater catchment plans for greenfield development, and managing contaminant loadings (including sediment) entering stormwater networks.

3.2.4 Waikato Regional Plan

Section 63(1) of the RMA directs a regional council to prepare a regional plan to assist a regional council to carry out any of its functions in order to achieve the purpose of this Act. The Waikato Regional Plan (April 2012) recognises the importance of effectively managing discharges to land and water. Stormwater discharges are addressed in Section 3.5 of the Plan. Section 3.5.3 contains the key policies:

- Policy 1 enables discharges that have only minor adverse effects and outlines the parameters for this.
- Policy 2 addresses the management of discharges to water with more than minor effects, among other matters, ensuring that there are no significant adverse effects from downstream siltation.
- Policy 3 considers the alternatives to direct discharge to water.
- Policy 7 encourages at-source management and treatment of stormwater discharges to reduce adverse water quality and water quantity effects of discharges on receiving waters. The associated explanation refers to statutory and non-statutory means to encourage stormwater management prior to its discharge to receiving waters.
- Section 3.5.11 outlines implementation methods associated with stormwater discharges. Among other matters, it states that Waikato Regional Council will work with resource users to:
 - Find ways to mitigate adverse effects of existing stormwater discharges.
 - Promote the development of stormwater management plans which record the way in which the stormwater network is operated, including methods to avoid, remedy or mitigate the adverse effects of stormwater discharge.
 - Promote alternative methods for the treatment and disposal of stormwater from existing and new subdivisions and development.

3.2.5 Healthy Rivers Wai Ora: Plan for Change He Rautaki Whakapaipai

The Waikato community has consistently identified water quality as the top issue for the Waikato Region for the past two decades. Healthy Rivers/Wai Ora Proposed Waikato Regional Plan Change 1 is the bold response to addressing the complex problem of water quality facing our Waipa and Waikato Rivers. The proposed plan change gives effect to Government legislation on the management of fresh water (passed in 2014) and the Vision and Strategy for the Waikato and Waipa Rivers which was adopted by Government as part of Treaty Settlement legislation.

Through a collaborative plan making process, Plan Change One: Healthy Rivers Wai Ora: Plan for Change He Rautaki Whakapaipai has been developed and was publicly notified on 22 October 2016. The plan change is a change to the Operative Waikato Regional Plan (WRP) to restore and protect water quality in the Waikato and Waipa Rivers by managing discharges of nitrogen, phosphorous, sediment and microbial pathogens to land in the catchment, where it may enter surface water or groundwater and subsequently enter the rivers, or directly into a water body.

The regional council has a legal requirement to give effect to both of these. The proposed plan has been developed using a collaborative process involving community and sector representation which has ensured that those who are most affected by the changes have been

at the table developing the policy and providing input and feedback from their communities and sectors over a period of 2 – 3 years.

New rules will complement existing rules in the Waikato Regional Plan. Existing rules in the Waikato Regional Plan will continue to apply, e.g. farm dairy effluent rules, earthwork rules and point-source discharge rules.

3.3 Tangata whenua and te taiao

Māori see the natural world holistically – being wholly inter-connected and complementary. According to this concept Ranginui (sky), Papatūānuku (Earth), the mountains, open lands, rivers and the sea and the life therein exist seamlessly together and not as individual resources in isolation from one another.

Māori believe that humans, too, form part of the natural world. An interdependent relationship exists between humans and the natural world. This allows people to live off te taiao (the environment) and use resources but at the same time requires them to ensure that they are cared for and protected. This relationship extends from ancestral beginnings and carries with it resource management knowledge (a component of Mātauranga Māori) and responsibilities that are shared by successive generations. The nature of this relationship is recognised and provided for in Part II of the Resource Management Act.

Mātauranga Māori informs tikanga and kawa which guide resource management practices used by tāngata whenua. An example of such a practice is the imposition of rahui to enable regeneration of stocks, to preserve and protect species, or to minimise any adverse effects of resource use.

The relationship with te taiao suffers when tāngata whenua cannot fulfil their responsibilities, including managing resources to ensure mauri is preserved and that they are not depleted beyond their ability to replenish. These management responsibilities are embodied in the concept of kaitiakitanga. Kaitiakitanga extends beyond purely protection or preservation of resources to use and enjoyment, and includes for economic purposes.

An inability to influence decision making has been a long-standing and common concern of tāngata whenua within the Waikato Region. One of the impacts of this is on the ability of tāngata whenua to effectively carry out their kaitiaki duties. While there has been improvement in recent years, including through the settlement of Treaty of Waitangi claims, this remains an issue for tāngata whenua.

A lack of understanding, awareness and recognition of the nature and existence of cultural heritage and its importance to tāngata whenua has frequently led to the destruction of areas, sites, places, landscapes or resources of significance, or the destruction of their values and/or of the relationship of tāngata whenua with them.

The relationship tangata whenua have with the domains of Ranginui and Papatuanuku is of paramount importance and this relationship is being damaged through:

- Activities which degrade the mauri of the environment, including through cumulative effects
- Loss of access to, and use and enjoyment of, resources and places
- Loss or diminishment of the ability of tangata whenua to be involved in or influence management decisions, and
- Loss of ability to exercise and provide for kaitiakitanga

The Waikato Regional Policy Statement has numerous objectives that address the above issue, refer to the RPS for further information.

3.3.1 Tangata whenua and water

Maori have strong cultural, traditional and historic links with wetlands and inland waterways, including lakes, rivers, streams and springs. The taonga (treasures) are spiritually and closely linked to the identities of the tangata whenua (people of the land).

Water is the life giver, it represents the blood of Papatuanuku, the Earth Mother, and the tears of Ranginui, the Sky Father. Waterways are home to many taniwha (spiritual beings) that look after the people and ensure their physical and spiritual protection.

A valuable resource

Wetlands and waterways provide:

- Habitat and spawning grounds for native plants, birds and fish
- Building and weaving materials such as raupo and harakeke (flax)
- Medicines and dyes used for seasoning timber and restoring precious artefacts.

They are also a traditional source of food such as tuna (eel). Many people wish to re-establish wetlands as a source of traditional feed including eels, whitebait, mullet and watercress.

Protecting water resources

Maori are concerned about the damming, drainage and pollution of waterways because of their effects on the mauri (life force) of the waterways. The adverse effects of nutrient environment from farm runoff and leaching, urban stormwater discharges and pollution from industrial point sources are identified as problems.

In addition, land drainage, adjacent landfills, animal grazing and exotic plants have degraded many surviving wetland areas. Much of the remaining wetland is on private land and Maori may not have access to these places.

Maori see the protection and enhancement of existing wetlands as vital, particularly in terms of protection from inappropriate drainage or subdivision.

3.3.2 Tangata whenua and the land

Maori have strong spiritual bonds to the land, Papatuanuku, the Earth Mother. She provides unity and identity to her people and sustains them. It is important that we protect our land and water from erosion, deforestation and inappropriate land use.

Maori consider that Papatuanuku sustains all life, and that they are spiritually connected to her.

Maori regard land, soil and water as taonga (treasures). Maori are the kaitiaki (guardians) of these taonga, which provide a source of unity and identity for tangata whenua.

The loss of ancestral lands is a key issue for Maori. Maori want to use their own land management systems to protect and enhance land.

Soil as an important cultural resource

Soil resources are important for plant cultivation and for use as dyes. Taonga such as carvings were stored in peat soils in wetlands to both hide and preserve them during times of trouble.

Soil also has an important cleansing role. Maori perceive that only by passing treated waste (such as farm effluent, treated sewage, treated stormwater) through Papatuanuku can the mauri (life force) of water be restored.

Some iwi land is still covered with native forests. In other areas, Maori are concerned about environmental problems facing their lands. These include:

- Loss of forest cover on steep river headwaters increasing erosion, slumping and river siltation.
- Inappropriate land use

- Landfilling
- Deforestation, and
- The loss of soil quality for productive use.

3.3.3 Tangata whenua and mauri²¹

As kaitiaki, tangata whenua have the responsibility of ensuring that the spiritual and cultural aspects of resources are maintained for future generations. This involves the ongoing protection of mauri from damage, destruction or modification.

Mauri is a concept recognised by tangata whenua as the connection between spiritual, physical and temporal realms. Loosely translated as the life force or life essence which exists within all matter, mauri sits at the very core of sustainable design for tangata whenua and Te Ao Maori – the Maori worldview.

A key concern to tangata whenua is the effect on the mauri of water caused by pollution of a stream, river, estuary, catchment or harbour. This can be due to sediment entering waterways, loss of riparian margins and the loss of native habitat to support native flora and fauna.

Degradation of freshwater quality can also affect the ability for customary harvest and manaki²² due to depletion in, or in some cases the absence of, traditional mahinga kai²³ resources. Modification or destruction of wahi tapu²⁴ and wahi taonga²⁵ is another potential effect of freshwater degradation.

The revival and enhancement of mauri should be a focus during the design and construction phases through:

- A holistic approach to resource management
- Protection of habitats of edible plants and native aquatic life which are traditional sources of food for local Maori
- Restoring a buffer of native vegetation alongside waterways
- Water conservation
- Avoiding mixing waters from different sources.

3.3.4 Joint management agreements in the Waikato

Arrangements between the Crown and iwi ushered in a new era of Crown-iwi co-management of the Waikato River catchment. Co-management provides iwi with mechanisms to manage the river in partnership with central and local government.

Legislation was passed in 2010 covering Waikato-Tainui and its involvement in co-managing the Waikato River from the Karapiro Dam to Te Puaha o Waikato (Port Waikato).

Later that year legislation was passed covering Ngati Tuwharetoa, Raukawa and Te Arawa river iwi (specifically the hapu Ngati Tahu – Ngati Whaoa, Ngati Kearoa – Ngati Tuara and Tuhourangi - Ngati Wahiao). The co-management arrangements under this bit of legislation covers the Waikato River from Te Toka a Tia near Taupo through to Karapiro.

A third piece of co-management legislation covering Ngati Maniapoto – the Nga Wai o Maniapoto (Waipa River) Act 2012 – came into effect in April 2012. It was the catalyst for Ngati Maniapoto to enter into co-management arrangements with local government authorities for the Waipa River.

²¹ This section is sourced from Auckland Council's 'Stormwater Management Devices in the Auckland Region (Auckland Council, December 2017)

²² The ethic of holistic hospitality whereby tangata whenua have inherited obligations to be the best hosts that they can be

²³ Traditional food sources

²⁴ Any place or feature that has special significance to a particular iwi, hapu or whanau (eg. urupa (burial grounds), pa sites (historical settlements), or wahi pakanga (historic battlefield).

²⁵ Anything considered to be of value including socially or culturally valuable objects, resources, phenomenon, ideas and techniques

The co-management arrangements include joint management agreements between iwi and the regional council on the way they will work together.

The first of these agreements was signed with Ruakawa on 10 May 2012 at Pikitū Marae, south-west of Putaruru, while an agreement with Te Arawa river iwi was signed on 28 August 2012. An agreement for river related lands with Waikato-Tainui was signed on 10 December 2012, and the agreement with Ngati Maniapoto was signed on 3 April 2013 at Te Kuiti Pa. An agreement was signed with Waikato-Tainui on 18 June 2013 in Hamilton.

The most recent agreement was signed with Tuwharetoa on 26 February 2018. The signing ceremony was held at Waikato Regional Council.

On 22 December 2016 the Crown and the Iwi of Hauraki initialled a Collective Redress deed. It's expected Waikato Regional Council – which provides key catchment management services regionally – will play a part in the implementation arrangements once the settlements are enacted through legislation at an as yet to be determined time.

Waikato Regional Council is looking forward to working with the Hauraki iwi to achieve an integrated and coordinated approach to the management of the Coromandel, Waihou and Piako catchment waterways. The council has developed very positive working relationships under existing co-governance and co-management arrangements in other catchment areas and the experience gained over the years is expected to further assist our council in implementing the Hauraki collective settlement. The council remains committed to providing high-level catchment management services for all communities in the Coromandel, Waihou and Piako catchment areas.

3.3.5 Iwi management plans

An Iwi management plan is a document developed and approved by iwi to address matters of resource management activity of significance within their respective rohe/region. The plans can contain information relating to specific cultural values, historical accounts, descriptions of areas of interest (hapu/iwi boundaries) and consultation and engagement protocols for resource consents and plan changes.

Refer to 'Iwi management plan' on Waikato Regional Council's website for the Iwi management plans for the rohe/region.²⁶

These plans are taken into account by the council in the management of the region's natural resources, providing a formal way for iwi interests to be incorporated into the council's decision making process.

Iwi management plans and cultural assessments provide excellent resources for developing approaches to incorporating mana whenua values into development proposals. Early engagement with tangata whenua to consult on proposals is of paramount importance.

Tooku awa koiora me oona pikonga he kura tangihia o te maataamuri

The river of life, each curve more beautiful than the last

²⁶ <https://www.waikatoregion.govt.nz/Community/Your-community/iwi/Tangata-Whenua-Management-Plans/>

4 Receiving environments

Understanding where stormwater goes and the sensitivity of the receiving environment will determine the requirements for stormwater management. Having a greater understanding of where water drains to and the recognition that those receiving systems have value, are threatened and require a greater level of protection will improve awareness and action.

Receiving environments in the Waikato Region are varied, and include the following:

- Streams and rivers (including modified watercourses and artificial drains)
- Floodplains
- Wetlands
- Ground
- Karst geology
- Estuaries
- Harbours
- Open coasts
- Lakes, and
- Geothermal areas.

Each of these receiving environments is discussed below.

4.1 Streams and rivers

Streams and rivers provide a means of conveyance of stormwater from the tops of catchments to lakes, estuaries, harbours and open coast areas. Modified watercourses are natural systems that have been modified over time but are still considered to have the values of a natural watercourse in terms of hydrology and ecology. Modified watercourses are often referred to as “drains” and tend to be located within urbanised and agricultural environments. Artificial drains are drainage networks that have no natural portions from its confluence with a river or stream to its headwaters and have been created over many years to enable pastoral use of adjacent land. Artificial drains have less status than natural watercourses, however they still have constraints that need to be considered when a development is proposed to discharge to it.

As water in streams and rivers only moves in one direction (downhill) there is a constant loss of organisms and materials to the sea. The stream and river community is dependent on materials entering the system from mostly terrestrial ecosystems, typically as particulate matter (leaves, organic and inorganic matter). As a result, different streams and reaches of streams have different aquatic communities. Upland, fast-flowing streams with stony beds differ from slow-moving lowland rivers with muddy bottoms.

The dynamic nature of wet-weather flow regimes and water quality make it difficult to assess the impact of urbanisation and stormwater on aquatic ecosystems. The best way to determine whether a given stream or river is healthy is to consider two main components of stream systems: habitat and biology.

Urbanisation destabilises stream and riverbanks, increases sedimentation and transports urban contaminants into them. Sedimentation can smother bottom dwelling organisms and increased sunlight increases stream temperatures. Ecosystem function and quality increases with increased complexity, and the more complex the habitat, the more complex the ecosystem functions.

Silt laden Karapiro stream discharging into the Waikato River



Biology in streams and rivers includes the following:

- Periphyton – algae, bacteria and fungi that covers the bottom of slow moving streams and blue-green and filamentous green algae that flourish in hard rocky substrates that provide firm footing.
- Macrophytes – plants that are usually rooted and mostly submerged or floating. Macrophytes act as a physical surface for periphyton and insects.
- Benthic macroinvertebrates – bugs that process and utilise the energy entering streams from either organic materials or waste from human or animal sources. Macroinvertebrates are an excellent means to assess stream health, as certain species only exist where there is good water quality.
- Freshwater fish – Absence or presence of fish may provide a picture of overall health of a stream or river. Absence of fish from a stream or river could be related to barriers to fish passage downstream, habitat loss or water quality issues.

The main factors influencing stream and river biology include:

- Physical habitat
- Temperature
- Dissolved oxygen
- Suspended sediments
- Stream flow
- Nutrients
- Light
- Contaminants
- Instream barriers, and
- Loss of riparian vegetation.

In urban streams and rivers it is generally hard to ascribe a specific reason for poor biology, as it is often a combination of most of the factors contained in the above list.

For projects that drain to them, the main issues of concern relate to both water quantity and water quality. Depending on the location of the project in a catchment, peak flow control may be an issue. In addition, stream channel physical structure may be a concern and consideration given to either extended detention or reducing total volume of stormwater flows by either infiltration or evapotranspiration.

Water quality is a concern for urban stormwater discharges to streams and rivers, as discussed in Section 2.3, mechanisms to address water quality issues are provided in the Waikato Regional Plan and Waikato Regional Policy Statement.

A study of contaminants in urban stream sediments in Hamilton²⁷ indicates that zinc, lead or arsenic have the highest contaminant levels in sediments and copper is recommended for monitoring in future studies. The study did not consider dissolved or waterborne contaminant concentrations, which may make up a considerable component of the stormwater runoff quality.

Where urban development drains to a river or stream, consideration has to be given to water quantity, quality and stream or river instability.

4.1.1 Examples of impacted aquatic resources

The following summarises the findings of several studies that assessed the condition of existing aquatic resources in the Waikato Region:

- The Waikato River is one of the most impacted in New Zealand in terms of fish habitat. Loss of bush catchments due to farm and forestry development, heavy industry discharges, floodplain and wetlands loss, heavy recreational and commercial harvest and flood protection have all combined to significantly reduce the fishery of the river.²⁸
- Macroinvertebrate sampling has been undertaken in streams and rivers for a number of years and trends up to 2005 indicate that lower values exist for sites with adjacent reaches and upstream catchments dominated by pasture compared to indigenous vegetation.²⁹
- Other monitoring of invertebrate populations in the Waikato, Waihou and Waipa Rivers was undertaken in 2001³⁰. Decreasing scores on the Waikato River were attributed to the decline of water quality moving downstream.

4.2 Floodplains

Floodplains occupy those areas adjacent to stream channels that become inundated with stormwater during large rainfall/runoff events. In general rainfall (in conjunction with inadequate drainage capacity) is the main cause of flooding, although surges by wind driven currents can exacerbate the problem, or in unique situations, cause the flooding problem. Flooding problems result from two main components of precipitation: the intensity and duration of rainfall, and its areal extent and distribution.

Te Puru 2002 flood



²⁷ Clearwater, 2012

²⁸ Speirs, 2001

²⁹ Collier et al, 2006

³⁰ Taylor A., 2001

Flooding has been the most common reason for declarations of civil defence emergency in New Zealand. Despite extensive river and catchment control schemes, damage from flooding nationwide is estimated to cost at least \$125 million a year. Many studies have shown that paving and drainage systems in urban areas increase flooding, particularly as many urban areas are located along floodplains and former wetlands.

Flooding in and of itself is not a problem. Floods have been occurring since the beginning of time and are a natural part of the water cycle. Problems are caused when man interacts with the floodplain. Thus, flood hazard potential relating to human health, property damage, and social disruption are strongly influenced by human activity within the floodplain. There are several key catchment characteristics which impact flood frequency and depths, these are discussed further below:

- Catchment size and slope
- Surface conditions and land use
- Floodplain topography.

4.2.1 Catchment size and slope

The abundance of rainfall in the region feeds small first and second order streams. These streams and their associated floodplains are the conveyance means of getting water downstream, through the catchment and to the sea. Smaller catchments have a rapid response time to storm flows where larger catchments have a longer response time as storm flows take time to travel through the drainage system.

4.2.2 Surface conditions and land use

Until the nineteenth century, 75% of the country was covered in temperate rainforest. Replacing two-thirds of it with exotic grasses has dramatically increased the rate at which rain reaches the ground surface and flows overland into the stream system.

Urbanisation, with its impervious surfaces has an even more profound effect on flood flows. Not only do floods increase in size and frequency, but also their speed of onset is increased, particularly with the first 20% of change from pervious to impervious cover. This makes intensive, short-duration rainfall events more problematic in terms of flooding. In addition, the time of year can impact on flood levels via the intensity of rainfall and the saturated condition of soils.

Table 4-1 provides typical values of roughness coefficients for floodplain areas for the purposes of hydraulic calculations to determine flow velocities and elevations. They indicate the value that vegetation has on the movement of flood flow and can be considered in the context of retardance factors. The higher the roughness value is, the greater the retardance to flow movement through it.

Table 4-1: Values of the Mannings roughness coefficient 'n' in floodplains³¹

Type of Ground Cover	Normal n
a. Pasture, no brush	
1. Short grass	0.030
2. High grass	0.035
b. Cultivated areas	
1. No crop	0.030
2. Mature row crops	0.035
3. Mature field crops	0.040
c. Brush	
1. Scattered brush, heavy weeds	0.050
2. Light brush and trees	0.060
3. Medium to dense brush	0.100
d. Trees	
1. Heavy stand of timber, little undergrowth	0.100
2. Heavy stand of timber, flood stage in branches	0.120

³¹ Delaware Department of Natural Resources and Environmental Control, 1997

As can clearly be seen, the denser and taller the vegetation, the greater the frictional resistance to stream flow.

4.2.3 Floodplain topography

The channel form and associated floodplain in part determine the size of flood, particularly its depth and areal extent. A small catchment and wide floodplain will result in a shallow widespread flood. Whereas a deep channel and steep slopes will result in deeper flooding with a small areal extent.

The many benefits that floodplains provide are partly a function of their size and lack of disturbance. However what makes floodplain particularly valuable ecologically is their connection to water and the natural drainage systems of wetlands, streams and estuaries. The water quality and water quantity functions provided by the floodplain overlap with the landscape functions of tract size and ecosystem complexity to make them exceptionally valuable natural resources.

4.2.4 Floodplain values

Floodplains provide a wide range of benefits to both human and natural systems. These functions and values can be broadly placed in three categories; water resources, living resources and societal resources, these are discussed further below.

4.2.4.1 Water resources

Floodplains provide for flood storage and conveyance during periods when flow exceeds channel boundaries. In their natural state they reduce flood velocities and peak flow rates by out of stream bank passage of stormwater through dense vegetation. They also promote sedimentation and filter contaminants from runoff. In addition, having a good shade cover for streams provides temperature moderation of stream flow. Maintaining natural floodplains will also promote infiltration and groundwater recharge, while increasing or maintaining the duration of stream base flow.

Floodplains provide for the temporary storage of floodwaters. If floodplains are not protected, development will, through placement of structures and fill material in the floodplain, reduce the floodplain's ability to store and convey stormwater when the need for floodplain storage occurs. This, in turn, increases flood elevations upstream of the filled area and increases the velocity of water travelling past the reduced flow area. Either of these conditions can cause safety problems or cause significant damage to private property.

4.2.4.2 Living resources

Natural floodplains are fertile and support a high rate of plant growth, which supports and maintains biological diversity. They provide breeding and feeding grounds for fish and wildlife. In addition, they provide habitat for rare and endangered species.

Ground cover in natural wetlands tends to be composed of leaf and dense organic matter. Organic soils have a lower density and higher water holding capacity than do mineral soils. This is due to the high porosity of organic soils or the percentage of pore spaces. This porosity allows floodplain soils generally to store more water than mineral soils would in upland areas.

4.2.4.3 Societal resources

Floodplains provide areas for active and passive recreational use. They increase open space areas and provide aesthetic values. They also contain cultural and archaeological resources and provide opportunities for environmental and other studies. Human development historically has occurred around waterways for food and transportation. Many walkways exist in reserves and those walkways tend to be adjacent to stream channels.

Where development drains into streams or rivers that have floodplains, the quantity of stormwater needs to be considered in the context of increasing peak flows.

4.3 Wetlands

Wetlands, as defined in the Resource Management Act, include permanently or intermittently wet areas, shallow water and land water margins that support a natural ecosystem of plants and animals that are adapted to wet conditions. They occur on land-water margins, or on land that is temporarily or permanently wet. Wetlands are a major habitat for at least eight species of indigenous freshwater fish as well as frogs, birds and invertebrates. Wetlands have unique hydrological characteristics that can be irreversibly modified by activities such as drainage.

There can be few other natural areas that have suffered so severely during human times than have wetlands. The reasons for this are many, however can be attributed largely to their position on flat land, suited to agriculture and to the generally low value that was given to such natural areas. These changes have occurred despite the value of wetlands as wildlife habitats, as regulators of flooding, their intrinsic values, for recreation and for scientific research. A far larger area of wetland than remains today has been lost through drainage, fire, top-dressing and flooding.

Nationwide, freshwater wetlands covered at least 670,000 hectares before European settlement but have now been reduced by drainage for pasture to around 100,000 hectares. Although several thousand wetlands still survive, most are very small and have been modified by human activities and invasive species. It is likely that some characteristic wetland types have been lost completely, while very few examples are left of others, such as kahikatea swamp forest and some kinds of flax swamp.

Whangamarino Wetland (lower end)



New Zealand's wetlands are as varied as the terrain that shapes them.

It is important to recognise that even without the presence of humans, wetlands systems are modified and eliminated by a natural ecological ageing process referred to as succession. The filling and conversion of wetlands into more terrestrial type ecosystems occurs naturally at a relatively slow rate. The intervention of man into the process vastly accelerates this conversion process.

In their natural condition, wetlands provide many important functions to man and the environment. Table 4-2 summarises the major functions and values of wetlands.

Table 4-2: Summary of wetland functions and values

Function/value	Description
Flood control	Attenuation of peak flows Storage of water Absorption by organic soils Infiltration to groundwater
Flow attenuation	Maintenance of stream flow during droughts
Erosion control	Increased channel friction Reduction in stream velocity Reduction in stream scour Channel stability by vegetative roots Dissipation of stream energy
Water quality maintenance	Sedimentation Burial of contaminants in sediments Adsorption of contaminants to solids Uptake by plants Aerobic decomposition by bacteria Anaerobic decomposition by bacteria
Habitat for wildlife	Food Shelter/protection from weather and predators Nursery area for early life stages
Fisheries habitat	Galaxids, eels, freshwater mussels, crayfish
Food chain support	Food production from sun (primary production)
Recreation/aesthetics	Enjoyment of nature Hiking, boating, bird watching
Education	Teaching, research

In addition to the listed beneficial values, the water quality benefits of wetlands can be expanded. Natural wetland systems have complex mechanisms and the following listing of benefits describes the major processes occurring in wetlands that allow them to provide water quality enhancement functions. These functions include:

- Settling/burial in sediments
- Uptake of contaminants in plant biomass
- Filtration through vegetation
- Adsorption onto organic material
- Bacterial decomposition
- Temperature benefits, and
- Volatilisation.

Before European settlement, freshwater wetlands covered 5% of the Waikato Region. Today the extent is only 1% coverage or an 80% reduction in the extent of wetlands in the region.

Stormwater management systems that drain into wetlands should be designed for water quantity, quality and stream or river instability.

4.4 Ground

There are four issues related to site development and associated stormwater management and interaction with ground:

- Soil compaction
- Contamination of soils
- Migration of contaminants to groundwater, and
- Soil type.

4.4.1 Soil compaction

In rural areas, moderate soil compaction under pasture is widespread across the region. This decreases soil productivity and increases surface runoff. Excess stocking rates and/or mismanagement leads to trampling of soil, breaking up the soil structure and compressing spaces in the soil.³²

Soil disturbance/compaction in urban areas occurs during construction cutting and filling operations, general grading operations and other processes of running heavy equipment over the soil. After construction, continued compaction can occur with site activities such as walking, sports and even parking heavy vehicles on grassed areas. Slow improvements in soil compaction may occur with time in relatively undisturbed areas by deep-rooted plants or by soil insects or other boring animals.

Soil infiltration performance is normally significantly degraded compared to natural soil conditions and is commonly overlooked during hydrologic analyses and design. Knowing the likely effects of this soil compaction on urban hydrological conditions is critical for designing safe drainage systems.

Soil compaction in the Waikato Region is an increasing problem.

4.4.2 Contamination of soils

Contamination of soils can occur as a result of past or present land use of a given site that could include:

- Use of agricultural chemicals (particularly glasshouses, orchards, vineyards, market gardens)
- Disposal of wastes
- Accidental spillage or leakage of chemicals
- Storage or transportation of raw materials, finished products or wastes, and
- Migration of contaminants into a site from neighbouring land, either as vapour, leachate or movement of liquids through the soil.

³² Environment Waikato, 2008

Migration of contaminants to ground



Land where contaminants are present in the soil, sediment, groundwater or surface water could indicate a short or long-term risk to human health and the environment. Impacts on human health from contaminated soil can arise from ingestion of soils, consumption of vegetables from the site, uptake and subsequent bioaccumulation by plants and animals.

Impacts on the environment can occur from a number of routes including direct uptake of contaminants by plants and animals, or migration of contaminants to ground or surface waters. Some contaminants such as copper or zinc are far more toxic to aquatic plants and animals than to humans.

4.4.3 Migration of contaminants to groundwater

Passage of water through the ground is part of the water cycle where water soaks into the ground and flows through it to an aquifer. It is mainly derived from rainfall that has soaked into the ground rather than runoff that travels over the ground surface. It can also be derived from water soaking into the ground from streams or lakebeds.

Water that soaks into the ground moves down through soil pores or rock fractures until it hits the water table. The zone above the water table is known as the unsaturated zone. Below the water table, soil pores or rock fractures are fully saturated, and the groundwater mainly moves laterally through these pores and fractures. A representation of groundwater movement is shown in Figure 4-1.

Groundwater underlies most of New Zealand. Differences in geology, hydraulic properties of the soil or rock, topography, recharge rates and relationships with surface waters mean that groundwater flow and bore yields are greater in some areas than others.

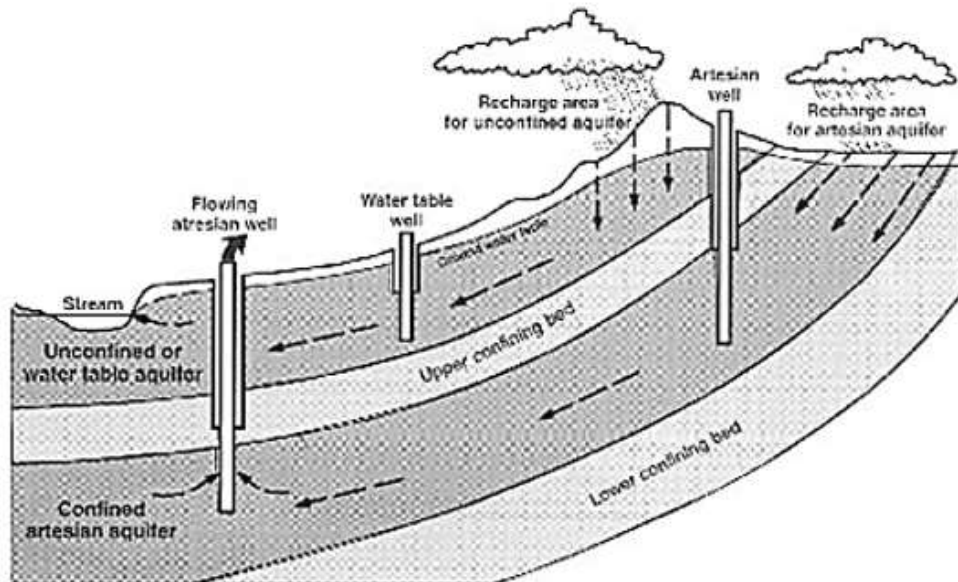

Figure 4-1: Groundwater movement³³

Principal concerns relating to groundwater are water quality and groundwater recharge. Poor stormwater runoff quality can contaminate groundwater and increased impervious surfaces can reduce groundwater recharge. While recharge of groundwater can be important, it is not recommended that infiltration devices accept untreated stormwater runoff for three reasons:

- Potential clogging of the infiltration system
- Potential migration of contaminants to groundwater, especially during accidental spills, and
- The ground itself is a receiving system and contamination of soils needs to be prevented.

The Institute of Geological and Nuclear Sciences reported on groundwater quality in New Zealand and identified two major national-scale groundwater quality issues³⁴:

- Contamination with nitrate and/or microbial pathogens, especially in shallow wells in unconfined aquifers, and
- Naturally elevated concentrations of iron, manganese, arsenic and/or ammonia, especially in deeper wells in confined aquifers.

The health-related guideline values for nitrate and indicator bacteria are exceeded at 5% and 20% of the monitoring sites for which indicator data were available, respectively.

The primary concern when ground is the receiving environment is stormwater quality. Water quantity issues are only indirectly related in that storage of excess runoff needs to be provided if the runoff rate exceeds the rate of infiltration.

4.4.4 Soil type

There are specific soil types in the Waikato Region that have characteristics that need to be considered when undertaking land development and designing a stormwater management system. Two of these soil types are discussed briefly below.

Pumice soils³⁵

Pumice soils are mostly derived from one of the greatest volcanic eruptions ever known from the crater now occupied by Lake Taupo. Pumice soils are sandy or gravelly soils dominated by

³³ Shaver et.al, 2007

³⁴ Institute of Geological and Nuclear Sciences, 2007

³⁵ The information in this section is sourced from: <https://soils.landcareresearch.co.nz/describing-soils/nzsc/soil-order/pumice-soils>

pumice, or pumice sand with a high content of natural glass. Drainage of excess water is rapid but the soils are capable of storing large amounts of water for plants.

Pumice soils occur predominantly in the central North Island, particularly in the Volcanic Plateau. They cover 7% of New Zealand. Figure 4-2 below shows the general location of pumice in the central North Island.

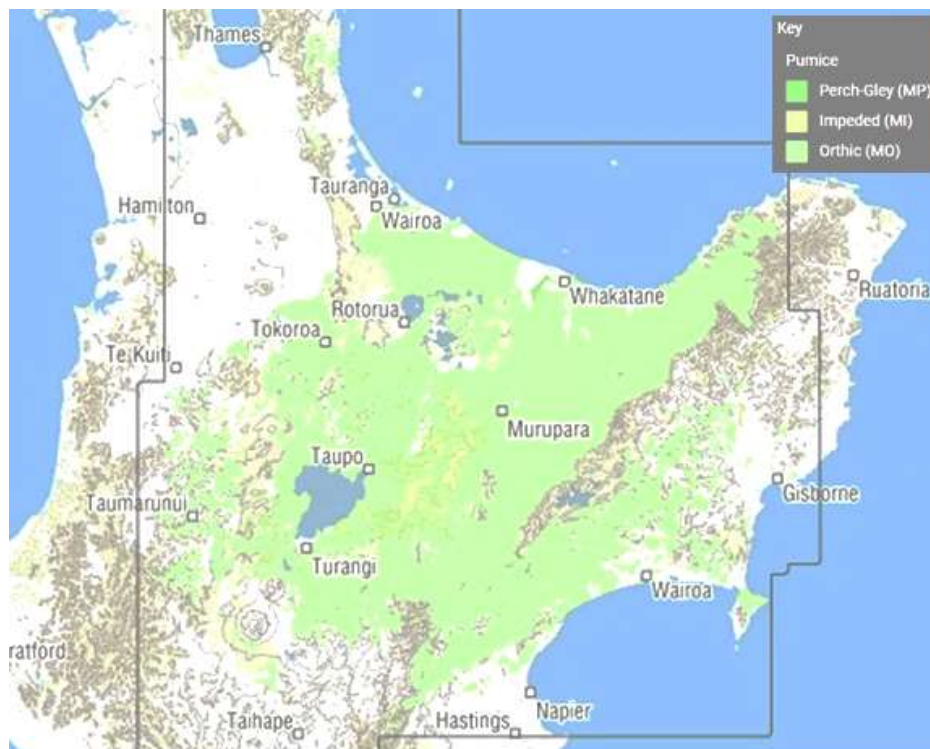

Figure 4-2: Location of pumice soils in the Central North Island³⁵

Pumice soils have low strengths, high macroporosity, and deep rooting depth. They are highly crushable, compressible and lightweight, making them problematic from an engineering perspective³⁶. Pumice soils have low strength when disturbed, hence easily erode if the surface vegetation and thin topsoil are removed, and are easily compacted reducing post-development permeability.

When undertaking development in areas with pumice soils, and designing stormwater management systems, care needs to be taken to avoid causing adverse erosion and scour effects and the formation of tomos. Care should also be taken to mitigate the effects of soil compaction by remediating soils or limiting tracking over areas to retain pre-development permeability.

Organic soils/peat³⁷

Organic soils are formed in the partly decomposed remains of wetland plants (peat) or forest litter. Some mineral material may be present but the soil is dominated by organic matter. Organic soils occur in wetlands in most parts of New Zealand, or under forests that produce acid litter in areas with high precipitation and they cover 1% of New Zealand. Figure 4-3 below shows the general location of organic soils in the central North Island, with larger areas being present around Hamilton.

³⁶ Orsense et al, 24 November 2017

³⁷ The information in this section is sourced from: <https://soils.landcareresearch.co.nz/describing-soils/nzsc/soil-order/organic-soils/>

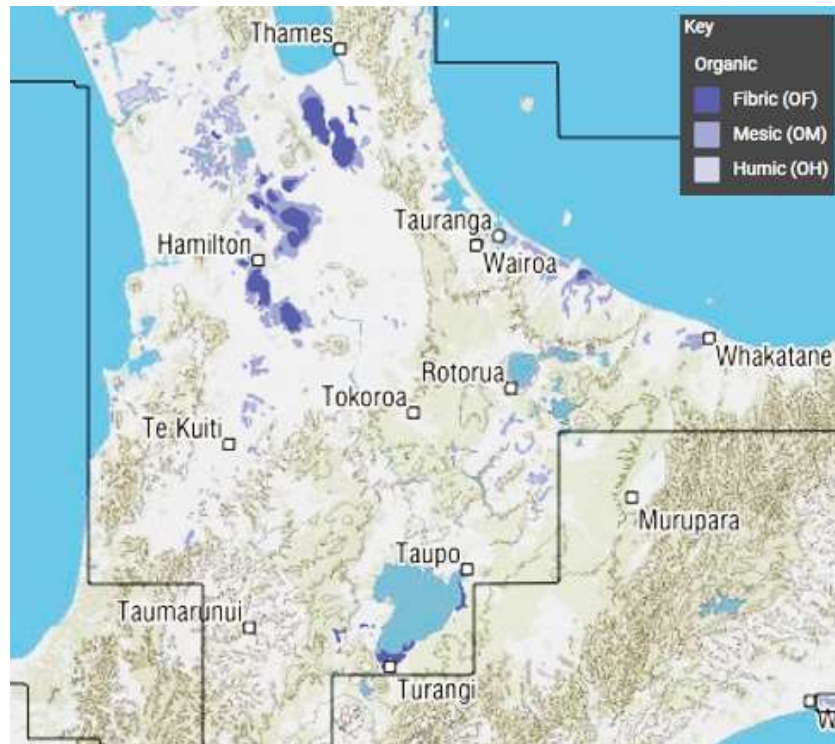

Figure 4-3: Location of organic soils in the Central North Island³⁷

Organic soils have very low bulk densities, low bearing strength, high shrinkage potential when dried and very high total available water capacity. Organic soils are usually strongly or extremely acidic.

From a stormwater management perspective, when there are organic soils present care needs to be taken to maintain groundwater levels so that organic soils do not shrink leading to potential ground settlement.

Natural settlement does occur of organic materials over time as materials decompose. Settlement is increased by over-drainage. There are some catchments in the Waikato to the north of Hamilton that have large amounts of organic soils present, these catchments are very flat with elevated groundwater levels. As the organic soils settle with time, gradients change and can lead to altered drainage regimes.

If land development is occurring in an area where organic soils are present it is important to understand where the organic soils are relative to the site, including off-site in the hydrological catchment that the site sits within, and that future settlement is considered when designing the stormwater management system. Naturally high acidic soil conditions will also need to be considered as this may change the chemistry of the surface water.

Karst geology

The karst landscape of south-western Waikato (Maniapoto Karst) created through limestone dissolution, is one of the region's iconic landforms. The caves, springs and other features associated with this landform are valued for their association with Ngati Maniapoto culture, unique natural heritage attributes, utility for recreation and tourism, and their role in supply of water. Despite their regional significance, our knowledge of the structure and functioning of karst aquatic ecosystems is limited and this may constrain effective management of aquatic ecosystems in karst landscape.³⁸

Karst topography is characterised by subterranean limestone caves carved by groundwater. Karst landforms are generally the result of mildly acidic water acting on weakly soluble limestone bedrock. The mild acidic water begins to dissolve the surface along fractures or bedding planes in the limestone bedrock. Over time these fractures enlarge as the bedrock continues to

³⁸ Scarsbrook et al, 2008

dissolve. Openings in the rock increase in size and an underground drainage system develops, which allows more water to pass through the area and accelerating the formation of underground karst features. The mildly acidic water results from rain passing through the atmosphere picking up carbon dioxide, which dissolves in the water. Once the rain strikes the ground it may pass through soil having more carbon dioxide and forming a weak carbonic acid which dissolves calcium carbonate.

Within karst landscapes there is clear evidence that alteration of vegetative communities of any sort can lead to substantial and potentially irreversible impacts on the karst processes operating in that area.³⁹

Most dissolving of limestone happens just beneath the soil. This is where carbon dioxide is generated by soil microbes, so percolating water has its highest level of carbon dioxide. Some 90% of dissolving can occur in the top ten metres of the limestone outcrop.

Environmental issues related to land alteration in karst terrains include:

- Soils in karst terrains are moderately to poorly permeable, yet there is little surface runoff. Thus rainwater is diverted underground through sinkholes and/or by diffuse recharge through the overburden into numerous small fractures in the limestone.
- Contaminants can pass rapidly through the subsurface system with little or no modification other than advective dissipation.
- Long residence times, confined aquifers and lack of natural filtration create special needs regarding groundwater protection in karst.

Key elements to consider when planning to undertake development on karst terrains include:

- Minimise site disturbance and changes to soil profile including cuts, fills, excavation and drainage alteration.
- Retention ponds should only be used as a last resort after all other control options have been considered and rejected. In the rare instance they are employed they should serve small catchment areas (< 2 ha) and be located away from known karst features. If detention of water is a design requirement then the bottom and sides of the detention device must be impermeable so there is no soakage into the ground.
- Where possible, runoff should be maintained as sheet flow to avoid it becoming concentrated with flows dispersed over the broadest area possible to avoid ponding, concentration or soil saturation.

4.5 Estuaries

Estuaries are low energy, depositional zones where the sea meets streams and rivers. They tend to be semi-enclosed coastal bodies of water with one or more rivers or streams flowing into them and with a free connection to the sea. Estuaries are often associated with high rates of biological productivity.

³⁹ Urich, 2002

Otahu Estuary



From a New Zealand perspective, estuaries seethe with bacteria, mud worms, crabs, migrating fish, mangroves and oystercatchers. This system has evolved in the mud flats and is vulnerable to tide, erosion, contamination and other effects of human activity.

An estuary is typically the tidal mouth of a river and they are often characterised by sedimentation from silts carried from terrestrial runoff. The water in estuaries is generally brackish. Estuaries are marine environments, where pH, salinity, and water level are varying, depending on the tributaries that feed them and the ocean that provides the salinity. There are various types of estuaries:

- Salt wedge – in this situation the river output greatly exceeds the marine input and there is little mixing.
- Highly stratified – river outputs and marine input are more even, with river flow still dominant. Turbulence induces more mixing of salt water upward.
- Slightly stratified – river input is less than the marine input. Turbulence causes mixing of the whole water column.
- Vertically mixed – river input is much less than marine input, such that the freshwater contribution is negligible.
- Inverse estuary – these are located in areas with high evaporation and where there is no freshwater input.
- Intermittent estuary – this type of estuary varies dramatically depending on freshwater input, and is capable of changing from a wholly marine embayment to another estuary type.

Due to estuaries being low energy environments and having a high salinity, they are depositional zones where sediments and contaminants become deposited. Estuaries are sinks where contaminants accumulate and concentration levels can be expected to increase.

The Waikato Region has about 35 estuaries, making up over half of the region's 1,150 km of coastal shoreline⁴⁰. There are settlements near all of the major estuaries in the region. The region's estuaries are important places, and have the following uses:

- They are used for swimming, boating, fishing and shellfish gathering.
- They provide locations for marinas and marine farms.
- There are the feeding, spawning and nursery habitats for many fish, shellfish and birds.

One way of measuring the importance of estuaries is by estimating the value of the ecosystem services they provide, such as food production, recreation and habitat for plants and animals. Preliminary estimates indicate that the total value of ecosystem services provided by the

⁴⁰ <https://www.waikatoregion.govt.nz/Environment/Natural-resources/coast/Coastal-ecosystems/Estuaries/>

region's estuaries is about 20 times higher than forests and about 50 times higher than land used for farming or horticulture.⁴¹

In terms of stormwater management, neither peak flow nor stream erosion are considered to be concerns. The main issue is water quality. In addition, water quality may relate to a wide range of contaminants.

4.6 Harbours

Harbours are primarily natural landforms where a body of water is protected and deep enough to furnish anchorage for ships. They differ from estuaries in that tidal action is greater and rates of deposition of sediments are less. Sedimentation does still occur and most harbours of the world require dredging to maintain shipping channels.

The Region has a number of harbours including:

- West Coast harbours – Whaingaroa (Raglan), Aotea and Kawhia and the mouths of the Mokau, Awakino, Marakopa and Waikato Rivers.
- Coromandel Peninsula east coast harbours – such as Whangamata, Tairua, Whitianga and Whangapoua.
- Coromandel Peninsula West Coast harbours – including Manaia, Te Kouma and Coromandel.
- The Firth of Thames.

Whangamata Harbour



From a stormwater management perspective, neither water quantity peak flows nor stream channel erosion are considered as issues needing to be addressed if harbours are the receiving system of concern.

From a water quality perspective, harbours are not as sensitive as estuaries and streams from a contamination standpoint and implementation of stormwater management will probably relate to the magnitude of the project being proposed and the council requirements.

4.7 Open coasts

Open coasts are the line of demarcation between the land and the ocean. They are dynamic environments and go through constant change. Natural processes, particularly sea level rise, waves and various weather conditions have resulted in erosion, accretion and reshaping of coasts as well as flooding and creation of continental shelves and drowned river valleys.

Coasts face many environmental challenges relating to human-induced impacts. The human influence on climate change is considered to be a major factor

Whiritoa



⁴¹ Patterson et al, 1998

contributing to the accelerated trend in sea level rise. In addition, urban development of coastal land contributes to aesthetic problems and reduced natural coastal habitat.

The region has approximately 1,150 km of open coast and shoreline including estuaries.

Overall the quality of coastal water in the region is high. The open coasts are well-flushed and the permanent population of coastal towns is relatively small. Runoff from the land through rivers and catchments is the main source of contaminants flowing into coastal waters.

Depending on littoral drift, the major concern on urban land use adjacent to open coasts would be litter control. When looking at impacts related to open coasts, a primary concern has been sewage contamination of beaches, which is not necessarily a stormwater related issue. Litter is a visible contaminant and can be addressed through a number of actions including routine clean up or maintenance.

4.8 Lakes

A lake is a body of water that is contained in a body of land and, in the context used here, contains fresh water. Most lakes have an outfall but some do not. Lakes can be manmade or natural.

Contamination of lakes can occur through a number of factors. The amount of nutrients entering a lake can cause eutrophication. This is caused by nutrient loadings stimulating excessive plant growth, which in turn decreases the amount of oxygen in the water and eventually causes fish and animal kills. Ecology of lakes is very different from that of streams due to standing water, temperature effects, and contaminant accumulation.

The region has over 100 lakes that range in size from small ponds to the largest lake in New Zealand: Lake Taupo. Lake Taupo's water quality is excellent but increasing nitrate levels in the bottom waters could lead to increases in algae, which can reduce water clarity.

A study of shallow lakes in the region⁴² expresses concern regarding a trend of declining water quality in many of the shallow lakes. A key cause of decline in water quality is the increase in nutrients entering the lakes due to land use practices. This decline in water quality has been accompanied in many cases by a loss of indigenous biodiversity.

Lake Moana-nui outfall spillway



As part of another study, 52 lakes were evaluated using submerged plant indicators to assess and monitor lake condition⁴³ to describe the following:

- Pristine condition (lake plant communities in pre-impacted times)
- Historical condition (lake condition as described by historical data), and

⁴² Jenkins et al, 2007

⁴³ Edwards et al, 2009

- Present day condition (most recent data).

Using these three categories two lakes were classified in excellent condition, four lakes were considered to be in a high condition, eleven in moderate condition, eight in a poor condition and the remaining 27 lakes were classified as non-vegetated. All lakes have shown a significant reduction in SPI scores from the pre-1900 pristine state.

The main issues from a stormwater management criteria perspective relate to water quantity, water quality, tributary stream channel erosion and potential erosion of the outfall channel from lakes.

4.9 Geothermal areas

While not generally considered a receiving system, geothermal areas are important areas within the region and require some discussion.

The Waikato Region contains approximately 70% of New Zealand's geothermal resources, in terms of the number of known high-temperature systems, and in terms of stored heat calculations.⁴⁴ These resources are generally used for the following:



- A thermal energy source
- Domestic and commercial heating by hot water and steam
- Thermal bathing pools
- Commercial hot water operations such as prawn farming, tourism, glasshouses and timber drying
- The scientific study of geothermal features, processes and ecosystems
- Tourist attractions, and
- A source of micro-organisms for industrial processes.

The primary adverse impact that has occurred on geothermal features is large-scale extraction of energy and fluid leading to the demise of geysers, and to large-scale increases in heat flow.

There is no local documentation of urban stormwater as a contaminant of concern for geothermal areas but there is considerable documentation of the unique vegetation that occurs in geothermal areas and inappropriate urban development could have a significant adverse impact on the existing vegetation.

A survey of existing geothermal areas⁴⁵ has identified current threats, modification and vulnerability were evaluated. One threat is human disturbance and associated threats. These include:

- Exploitation of geothermal fields for energy production,
- Tourism and recreation – considerable damage can result from the construction of facilities such as tracks, roads and buildings.
- Dumping of rubbish,
- Pest plants,
- Domestic livestock damage,

⁴⁴ Lawless et al, 2001

⁴⁵ Wildland Consultants, 2011

- Plantation forestry and shelter belts,
- Introduced pest animals,
- Fire,
- Genetic pollution,
- Wetland infilling and drainage, and
- Industrial/residential/roading development.

The report recommends that thermal areas be protected from all of the threats listed above.

4.10 Stormwater management and receiving environments

To provide stormwater management context when considering receiving environments, Table 4-3 below summarises receiving environments and their respective stormwater issues. This table is meant as a general guide and does not substitute for regulatory requirements required by consenting authorities. Contact should be made with the appropriate territorial authority to ensure that any local requirements are complied with.

Table 4-3: Receiving environments and stormwater issues

Receiving system	Flooding issues	Stream erosion issues	Water quality
Artificial drains	High priority as drains are low capacity systems.	High priority	High priority
Streams (including modified watercourses)	May be a priority depending on location within a catchment	High priority if the receiving stream is a natural, earth channel	High priority
Rivers	Generally not an issue	Generally not an issue	High priority
Floodplains	Peak flows need to be considered downstream of development	Channel stability is considered as an issue of concern	Moderate priority
Wetlands	High priority	High priority	High priority
Ground	Not an issue depending on overflow	Not an issue	High priority
Karst areas	High priority	Not an issue	High priority
Estuaries	Not an issue	Not an issue	High priority
Harbours	Not an issue	Not an issue	Moderate priority
Open coast	Not an issue	Not an issue	Moderate priority
Lakes	Could be an issue if increased stormwater runoff increases lake water levels, even temporarily.	Tributary and outlet channel stability needs to be considered	High priority
Geothermal areas	Not an issue	Not an issue	Protecting existing land cover in areas adjacent to geothermal areas needs to be considered

5 Stormwater management concepts

This guideline provides a framework for implementation of stormwater management strategies to manage the effects of stormwater runoff from urban land use in accordance with Waikato Regional Council's regulatory framework.

The objectives in the regulatory documents discussed in the previous section clearly require effective management of stormwater quantity and quality from developed areas (including industrial areas) to mitigate downstream adverse effects and stress the need to protect streams from erosion while promoting alternative methods for the treatment and disposal of stormwater.

The Vision and Strategy requires the restoration and protection of the health and wellbeing of the Waikato River and the adoption of a precautionary approach to management of the natural, physical, cultural and historic resources of the Waikato River. The Vision and Strategy also requires the recognition and avoidance of adverse cumulative effects and potential cumulative effects, of activities undertaken both on the Waikato River and within its catchments on the health and wellbeing of the Waikato River. The Vision and Strategy requires a step change in how stormwater runoff is managed and requires that development is undertaken in such a way as to restore and enhance the Waikato River and its tributaries.

It is expected that similar requirements will be outlined for other major river catchments in the Waikato Region, including the Waihou and Piako River catchments.

This guideline provides information on the selection and design of stormwater management devices to achieve these objectives. However, prevention is better than cure. To best achieve required stormwater management objectives, stormwater management systems will need to be integrated with the development and the natural landforms within the site and catchment to reduce the potential stormwater related effects. Existing gullies, streams and wetlands are to be protected and restored.

Development proposals will need to demonstrate that all opportunities have been taken to avoid, remedy and mitigate potential adverse stormwater effects, and that all opportunities have been taken to protect and enhance the water bodies in the catchment.

A low impact design approach is considered necessary to meet these requirements for site design and for catchment management planning.

5.1 Avoid, remedy or mitigate

When considering the Resource Management Act, every person has a duty to avoid, remedy or mitigate any adverse effect on the environment arising from an activity. It is recognised that to avoid or remedy effects is much more cost-effective than to mitigate effects. Those three duties in relation to stormwater management are discussed further below.

5.1.1 Avoid

This includes approaches and practices that prevent stormwater becoming contaminated in the first place. Examples include the following:

- Use of building or safety materials or paints that do not leach contaminants
- Selecting an approach to development that has fewer adverse environmental effects
- Reducing the amount of impervious surface that is constructed
- Using new products that do not contain materials that, when wearing down, discharge contaminants, and
- Maintaining, to the degree possible, natural systems to reduce stormwater runoff or to provide stormwater quantity and quality control through flow retardance.

5.1.2 Remedy

In a similar fashion to avoidance, utilising practices or locations that prevent contaminants from coming into contact with stormwater can remedy an existing problem or prevent a future one occurring.

Poor engine tuning increasing contamination



Practices that remedy problems are to a large extent associated with non-structural practices. Non-structural practices, such as street sweeping, have been implemented in urban areas to reduce contaminant loadings in stormwater runoff, thereby reducing the need for more expensive structural practices.

In a study of stormwater characteristics for various land uses in the city of Austin⁴⁶, contaminant event mean concentrations (EMCs) were reduced in areas where street sweeping occurred at least once per week, versus those areas that did not receive street sweeping. The important element here is the frequency of sweeping. Increasing the frequency of sweeping increases the contaminant reduction benefits.

Examples of practices that could be considered to remedy potential effects include the following:

- Road and stormwater reticulation maintenance practices such as street sweeping (using high efficiency regenerative sweepers) and catch pit cleaning undertaken at appropriate frequencies
- Controls on illegal dumping
- Landscaping practices that reduce or eliminate the use of fertilisers, herbicides and pesticides
- Correct storage practices for potential contaminants
- Fleet vehicle maintenance programmes
- Covering contaminant generation areas on industrial sites, and
- Reduce, re-use or recycling programmes.

While it is much easier to avoid a problem by careful consideration before construction occurs, subsequent maintenance by substitution of products or by developing an environmental management plan for maintenance activities also can reduce or eliminate contaminants.

Individual actions, when taken in conjunction with other actions either on an individual site or on a more widespread basis, can reduce contaminant loadings over time. This is an issue that needs to be considered from both a developer context and by territorial authorities.

⁴⁶ City of Austin, 1990

5.1.3 Mitigate

Mitigation has been the historical approach to reducing stormwater contaminants downstream. Mitigation involves the construction of stormwater treatment devices to reduce the quantity of stormwater and the level of contaminants in stormwater runoff.

One purpose of this guideline is to provide design guidance for stormwater management approaches to mitigate potential stormwater effects. Any one approach, on its own, is unlikely to achieve the stormwater management objectives for a given project. For this reason, it is necessary to consider the objectives early in the design process when competing demands can be balanced and an integrated solution achieved. The need for, and size of, treatment devices is then minimised, as is their installation and maintenance costs. The combination of a number of different approaches or devices to achieve an overall stormwater objective is normally referred to as a “treatment train”, this is discussed further in Section 6.2.6.

Stormwater management has traditionally been undertaken using mitigation approaches only, using stormwater devices at the bottom of the hill to mitigate effects. More recently low impact design principals are being adopted, with stormwater managed at at-source with stormwater practices incorporated into the built form, hence leading to smaller stormwater management devices being required as a final step to reduce potential downstream effects. Low impact design is discussed further below.

5.2 Low impact design

Low impact design (LID) is based on the notion that environmental values can be less adversely impacted as new areas are developed throughout catchments if basic principles are followed. LID means understanding natural systems and making the commitment to work within the limits of these systems whenever and wherever possible. LID is based on the recognition that stormwater is ultimately a precious resource to be carefully managed, rather than a waste product in need of disposal.

LID is one name that is used to refer to this approach to stormwater management. It is also referred to as Sustainable Urban Design Systems (SUDS), Water Sensitive Urban Design (WSUD), Low Impact Urban Design and Development (LIUDD) or Water Sensitive Design (WSD). The philosophical approach is the same for all of these concepts and the terms can almost be considered interchangeable. In this guideline the term LID is used.

LID can be thought of in different ways. In this guideline, a broad distinction is made between those approaches that tend to manage stormwater largely through avoidance strategies versus those that are mitigative.

An example of an avoidance approach would be reduction in impervious areas. In such cases, the generation of stormwater itself is avoided or minimised. This reduction in stormwater quantity generally translates into a reduction in stormwater related contaminant loading.

It is not usually possible to avoid any increase in stormwater runoff from a proposed development, however the development and the associated stormwater management system should be designed to minimise runoff increases as much as possible. This would achieve both quantity and quality related management objectives more cost-effectively than other approaches to site development.

Mitigative devices, on the other hand, are designed to manage stormwater after it has been generated. As such, mitigative devices generally have to collect and control stormwater, typically with some type of structure or even a series of structures. Mitigative devices are difficult to design to control both peak rates of discharge and volume increases, as well as to remove as many contaminants as possible.

There are five basic principles associated with LID that are discussed below.

5.2.1 Achieve multiple objectives

Stormwater management should be comprehensive in scope, with management techniques designed to achieve multiple objectives, including peak flow and volume control, water quality treatment, temperature maintenance and enhancement of ecological and amenity values.

Comprehensive stormwater management involves addressing all of these aspects of stormwater. Complicated site configurations with multiple structural techniques may be required in some situations but the design objective is to provide simple, cost effective solutions to complex problems.

5.2.2 Integrate stormwater design early in the process

Stormwater management, when it is provided, is often only considered at the end of the site design process. Because of this poor planning approach, site design almost always provides less than desirable outcomes.

For stormwater management objectives to be achieved, stormwater must be incorporated into site design from the outset and integrated into conceptual site planning, just as traffic considerations are. Stormwater impacts may, in some situations, even be a factor in determining the type and extent of land use that is intended at a site.

Site developers and designers need to consider incorporation of LID practices into the overall site design process and not engineer them after the site layout is fixed.

5.2.3 Avoid rather than mitigate

Approaches to site design, which can reduce stormwater generation from the outset, are the most effective approaches to stormwater management.

For example, clustering houses significantly reduces lengths of roads when compared to a traditional low-density similar sized lot approach. Arrangement of units with minimal setbacks reduces driveway length. Reduction in street width and other street modifications can further subtract from total impervious cover. These important elements of site design are rarely thought of as a component of conventional stormwater systems, yet they achieve significant stormwater quantity and quality benefits.

In the same regard, reducing total site disturbance reduces the total amount of work required by erosion and sediment control devices during site development. Less site disturbance means less generation of sediments, which results in a lower potential for downstream sedimentation in streams and estuaries. Allowing existing vegetation to remain on sensitive areas such as steep slopes, or upstream of wetlands will reduce adverse impacts to downstream resources. As recognition of downstream receiving water impacts has increased, the potential for mitigation requirements to address the sediment impacts becomes more likely. Reducing the potential for sediment delivery would correspondingly reduce mitigation requirements and associated costs.

Mitigation devices will still be integral to site development in most cases. However avoiding stormwater impacts by careful site design to the extent possible will lessen the reliance on mitigation devices to reduce or eliminate adverse effects.

5.2.4 Manage stormwater at-source

From both an environmental and economic perspective, minimising the concentration of stormwater and its conveyance in pipes costs less money (by reducing pipe diameter or elimination of pipes) and helps to maintain natural hydrology.

Pipes, culverts, and elaborate systems of inlets to collect and convey stormwater work against these management objectives and generally make stormwater management more difficult as such systems concentrate flows and increase flow rates, with a result of exacerbating erosive potential.

A LID approach promotes the management of stormwater at-source as much as possible to lessen the quantity of stormwater to be managed and potential contamination effects. This

approach helps to reduce the reliance on mitigation devices to reduce or eliminate adverse effects downstream.

5.2.5 Rely on natural soil and plant processes

A LID approach incorporates the use of natural soil and plant processes to assist with managing the effects of stormwater.

The soil mantle offers critical contaminant removal functions through physical processing (filtration), biological processing (microbial action), and chemical processing (cation exchange capacity and other chemical reactions).

Plants similarly provide substantial contaminant uptake/removal potential, through physical filtering, biological uptake of nutrients and even various types of chemical interactions.

5.3 Approaches and techniques

The items identified in the following sections should be considered on every site where development is intended. A narrative in a design report should reflect the consideration given and the reasons for acceptance or rejection of the item.

Whilst some of the items discussed below are outside the scope of what is consented by the Waikato Regional Council, and relate to land use hence are under the jurisdiction of territorial authorities, it is important to consider how stormwater can be managed holistically irrespective of jurisdictions.

5.3.1 Low impact design approaches

LID approaches tend to be broader in scope than traditional stormwater management approaches as they involve the entire site. Site design/clustering is one broad approach. Reduction in imperviousness also transcends the more focused stormwater management device concept. The list of approaches includes:

- Planning/zoning (building)
- Clustering/lot configuration
- Reduced imperviousness
- Minimum site disturbance

LID avoids the basic issue of how much of what type of land use is to occur at any particular site but rather considers what level of development is appropriate when considering land sensitivities (slope, floodplain, wetlands, bush, etc.). The emphasis is to define what we can do to improve stormwater management primarily on a site-by-site basis, assuming that development continues to occur. In those cases where conventional development programmes cannot use low impact design, density reduction is an option.

Although development at the maximum allowable density has come to be the assumed norm in many cases, development at reduced densities may provide the economic use while balancing water and other ecological needs.

5.3.2 Low impact design devices

LID approaches tend, for the most part, to be preventive but this is not always true. Low impact approaches may include mitigative devices which are less damaging to receiving systems than traditional stormwater management devices. LID devices include an array of bioretention devices as well as vegetated filter strips and vegetated swales.

Low impact mitigative devices can and should be used with the approaches detailed above and with one another. It is important to be aware that there are far greater options available, and yet to be developed, than have been used to date.

5.3.3 Clustering and alternative lot configuration

Stormwater management is optimised when stormwater objectives are integrated into site planning from the earliest stage. The process translates into concentrating or clustering development so that the most environmentally sensitive areas of the site are left undisturbed or are subject to minimal disturbance.

Example of clustering on a residential development



Clustering offers tremendous potential in terms of stormwater benefits and overall resource protection. While clustering is an important approach to site development it can also have greater benefits when considered at a catchment level.

Although some density bonuses may be offered which increase density, clustering in a strict sense usually begins after the basic determination of how much of what type of land use (a certain number of single-family residences for example) is to be provided. In some cases, parcels may be combined to produce a broader development pattern, but a typical clustering design should reflect the existing pattern of ownership if it is to function properly. In some cases, the clustering concept may be structured to include different types of development, including single family and apartment concepts.

As an LID approach, clustering is important. From a stormwater management perspective, clustering minimises stormwater runoff and contaminant loading generation from the outset and therefore is preventive in nature. To maximise positive stormwater effects, clustering works well when used in conjunction with other low impact design approaches and practices. In many cases, a tight clustering approach to site design facilitates the use of other approaches and practices.

In order to achieve maximum benefit such as shown in Figure 5-1, substantial design flexibility must be maintained. In this figure the blue areas denote stormwater management areas. Clustering can be made to work effectively on a small site or a large one, but clearly the standards imposed on a 40-hectare site need to be different, possibly significantly different, than the standards imposed on a 4-hectare site. Clustering may involve lot design and arrangement only. Or clustering may transcend lot design and even involve changing types of residences. The challenge is to create a clustering system, which maximises clustering benefits such as open space preservation even as developer incentives are maximised as well.

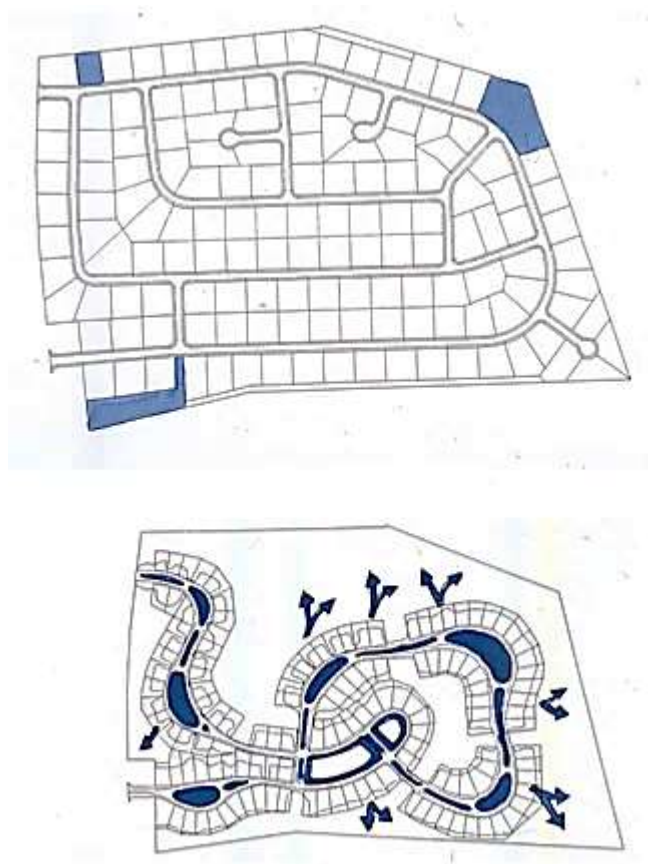

Figure 5-1: Conventional site development versus an LID approach⁴⁷

If clustering is not mandated, incentives may be provided to encourage its use. Many developers perceive clustered units on smaller lots as less valuable, so a density bonus provision is needed if the option is to be used (such as an increased number of lots). The clustering option may require additional consent processing requirements, which invariably requires more time, energy, and resources on the part of the developer. But this additional effort could result in significant cost savings during construction.

In addition, clustering may well require that a variety of provisions elsewhere in development requirements be modified. Setback provisions may have to be amended, as can be the case for any number of other dimensional requirements predicated on conventional subdivision design. Required street frontage, setback of the structure from the street, side and even rear yard setbacks become very different for cluster development than for conventional development.

Other important issues to keep in mind when considering clustering include:

- Are meaningful open space requirements established? Do these open space requirements vary with site size, type of use allowed, etc.?
- How is open space controlled and managed over the long term?
- Have water supply and wastewater provisions been incorporated?
- Have private property management systems been incorporated to the maximum extent feasible? Does the need for a private property management association discourage use of a clustering option?

Benefits achieved from clustering can be considerable and include the following:

- Reduction in imperviousness
- Reduction in contaminant loadings

⁴⁷ Delaware Department of Natural Resources and Environmental Control, 1997

- Preservation of special values and sensitive features
- Habitat protection and associated wildlife benefits
- Protection of aesthetic values
- Passive recreation and open space maintenance, and
- Reduction in costs, both development and operational.

Although reduced imperviousness is dealt with separately, it is such an important benefit from clustering that it deserves special mention. Holding all other aspects of the development constant (number of units, types of units), clustering significantly reduces impervious coverage. Impervious reduction is achieved mostly through reduced road construction and reduced driveway lengths. Given the direct relationship between imperviousness and stormwater generation, impervious area reduction can be expected to result in a comparable reduction in stormwater generation, both total volume and rate.

In addition to reducing site imperviousness, clustering also increases the potential to plant open spaces with native plants that may reduce future maintenance costs of grassed open spaces. Similarly increased open space may create recreation and amenity space.

5.3.3.1 Costs

Clustering significantly reduces costs through reduced land clearance, reduced road construction (including kerbing), reduced pathway construction, fewer street lights, less street tree planting, less landscaping, reduced sanitary sewer line and water line footage, reduced storm sewers, reduced sizing or need for stormwater management ponds, and other related infrastructure reductions. The costs of low impact design approaches is further discussed in Section 4.4 below.

5.3.3.2 Reduction in setbacks

The issue of minimum setbacks relates to low impact design in important ways. Standard building setbacks from roads are found in most territorial housing codes, and these requirements must undergo some change if clustering is advocated. While councils specify yard setbacks there are generally opportunities for these to be relaxed.

Councils are required to take account of the New Zealand Building Code provisions for fire and other safety purposes. In residential areas, side yards may be one metre in circumstances where sufficient vehicle access is provided to beyond the rear point of each dwelling or where a garage or carport is provided for. The Code allows for some discretion for further encroachments if the building has achieved a satisfactory fire rating. Minimum separation distances of 1340 mm are required between buildings except where there is a common wall. Again, flexibility may exist and further encroachments may be allowed if Fire and Egress Officers are satisfied and the appropriate consent is obtained.

5.3.4 Reduce imperviousness

Imperviousness is an essential factor to consider in stormwater management, both from a quality and quantity standpoint. Site-by-site and catchment-by-catchment, increased impervious cover means increased stormwater generation with increased contaminant loadings as well. Consequently, actions that can be taken that reduce impervious cover become important stormwater management strategies.

A variety of specific strategies to reduce imperviousness are described here. In many cases, planning for new street systems is often based on a hierarchical system where the function and use of the particular road can be linked to width and other characteristics relating to imperviousness. These low impact design approaches, in many cases, can stand-alone and be used development-by-development, although reduction in imperviousness also can be used with other approaches and practices.

Many councils have limitations on levels of imperviousness that can occur on residential developments but some see practical difficulties in monitoring/enforcement of such limits as individual property owners add impermeable structures after the building consent was issued.

A major variable in considering imperviousness is the consideration of transportation, which includes roads, kerbing, parking and footpaths.

5.3.4.1 Roads

Numerous demands are made on the road/road reserve resource. District Plan roading provisions have to reflect public demands for safe and efficient movement of pedestrians, cyclists, motor vehicles and for on street parking opportunities. Other utility services such as water, electric, sewage and stormwater disposal and telephone have traditionally been placed within the road reserve.

In all territorial authority areas, minimum street widths have been established which may be excessive and which may not reflect functional needs now or in the future. As an example, having a minimum road paving width of 7.5 metres for “first order streets” may be excessive since these streets may serve low numbers of residences. This width is costly to construct, requires expensive real estate, and creates far more stormwater than otherwise would be necessary. Because of the way in which so much development is configured, these streets are often just networks of cul-de-sacs specifically designed to exclude through traffic. In most cases such streets will not receive significantly increased traffic as an area develops. Consequently, traffic levels will never increase much beyond the traffic generated by the 15 or 20 houses lining the street.

Residential Street with gobi block parking, no kerb and drainage by swale



Street width reduction offers considerable potential benefit in terms of stormwater reduction. For the very smallest access street or lane with fewer than 100 vehicle trips per day, decrease street width to five metres and gradually increase road width correspondingly with traffic increases. In conventional developments with conventional lots and house design, there is no need to provide on street parking, although if tightly clustered configurations are used, on street parking may be a desirable option and included in the design.

Road lengths are also an important issue. Road length should first be addressed at the District Plan, Structure Plan, Neighbourhood Unit Plan level. Obviously overall dense patterns of development result in less road construction than do low density patterns, holding the number of units constant. High-density development and vertical development contrast sharply with the low density sprawl which has proliferated in recent years and which has required vast new highway systems in the urban fringe areas. Furthermore, the issue of concentration of development through increased density, while holding total amount of development constant, plays itself out at less macro levels of planning as well. As mentioned in the clustering discussion, road length is significantly reduced as tighter clustering occurs site-by-site. It is important to downsize streets, both their length and width, wherever possible.

Reasons for not encouraging reduction in road widths include: insufficient parking, insufficient room for passing parked cars, people drive on road verges, people try to drive both ways down one-way streets and the need for emergency or refuse vehicle access. Developments with narrower streets are perceived to be inferior if they reflect less than the minimum requirements. All of these possible reasons can be addressed through the development process to minimise any potential future problems.

5.3.4.2 Kerbing

The requirement for kerbing has a significant impact on stormwater flows. Kerbing immediately concentrates stormwater flows along the kerb and necessitates enclosed reticulation systems to convey the concentrated flow downstream. The end destination for these conveyance systems is either a stormwater device or a discharge directly into a receiving system. Kerbing is routinely required as a component of site development with little flexibility provided.

The provision of road drainage is generally engineering driven. Codes of practice tend to automatically assume the need for an enclosed system requiring road stormwater discharge to be managed.

Example of a Kerb Cut



It is not the intention here to advocate elimination of kerbing in all cases but rather to allow flexibility for where that option may be viable. There are other alternatives if kerbing is considered as essential in a development, such as using kerb cuts to maintain dispersed flow, which would then travel into a vegetated swale or across a buffer strip or into heavily vegetated areas. The key point is that flexibility is necessary to allow for stormwater management options.

5.3.4.3 Turnarounds

Imperviousness can be limited in turnarounds as well. Large diameter circles at the ends of low-density cul-de-sacs simply make no sense and create much more impervious area than is necessary. Figure 5-2 indicates turnaround options, culminating in the “T” turnaround, which has the least level of imperviousness and is appropriate for low-density cul-de-sacs where traffic flows are low. Individual levels of imperviousness are shown in the turnaround options having the dimensions shown in the figure. As can be seen the “T” turnaround option has imperviousness less than 50% of the next smallest option.

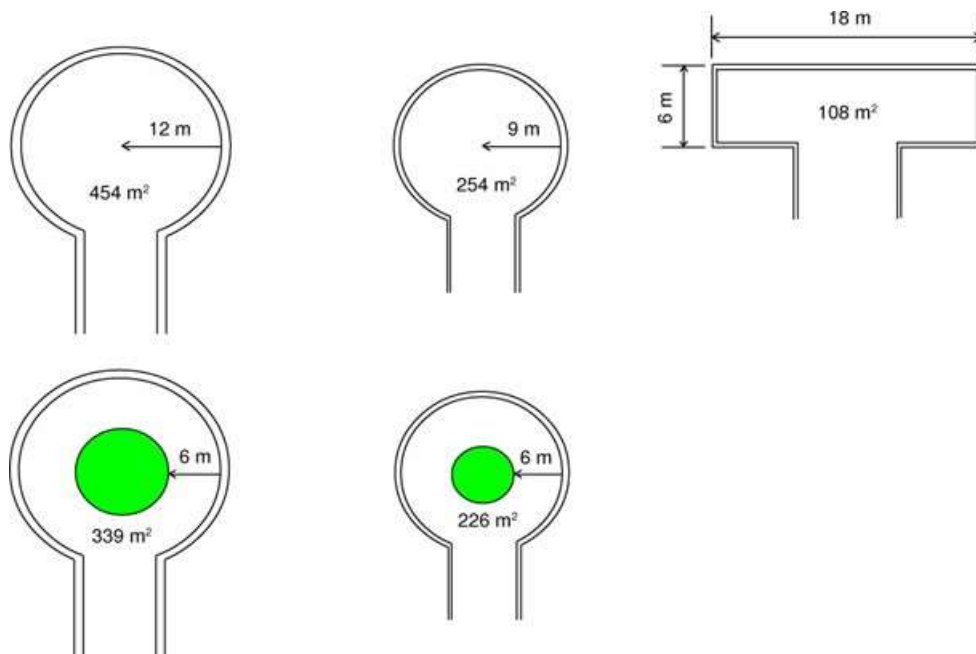

Figure 5-2: Turnaround options⁴⁸

5.3.4.4 Parking

Many different aspects of parking relate to stormwater problems, including parking ratio requirements as well as the design of parking spaces and their dimensions.

A discussion of parking as related to stormwater management links into larger planning issues quite quickly. But there are also low impact approaches to parking requirements that can minimise parking related imperviousness even where more conventional development modes are utilised. The trend in parking ratios in recent years has been to increase these ratios, perhaps reflective of the general increase in land development and traffic associated congestion and the concern of councils to err on the conservative side. In some cases (primarily in commercial areas) minimum parking ratios are even exceeded by developers. Councils typically establish minimum parking ratios, but rarely specify maximum parking ratios.

It should be noted that adjustment of ratios must be undertaken with care. Office parks, for example, are experiencing increasing employment intensities. As companies grow, more employees are hired; ratios of employees per square metre increase; cars increase and so does the need for increased parking spaces.

In terms of parking space design standards, this can be a significant contributor of overall site imperviousness. A standard dimension parking space can be 2.6-by-5 metres having a typical kerb overhang. When including the appropriate share of the parking aisle and the share of the common parking area, that impervious space can total over 30 square metres which is over twice as much as the actual parking area itself, as illustrated in Figure 5-3 below.

Reduction in the 25% shared area or reducing the number of parking spaces can provide a significant reduction in overall site imperviousness. Larger cars having a reduced turning radius are increasing the problem of parking lot sizing increases.

⁴⁸ Shaver, 2000

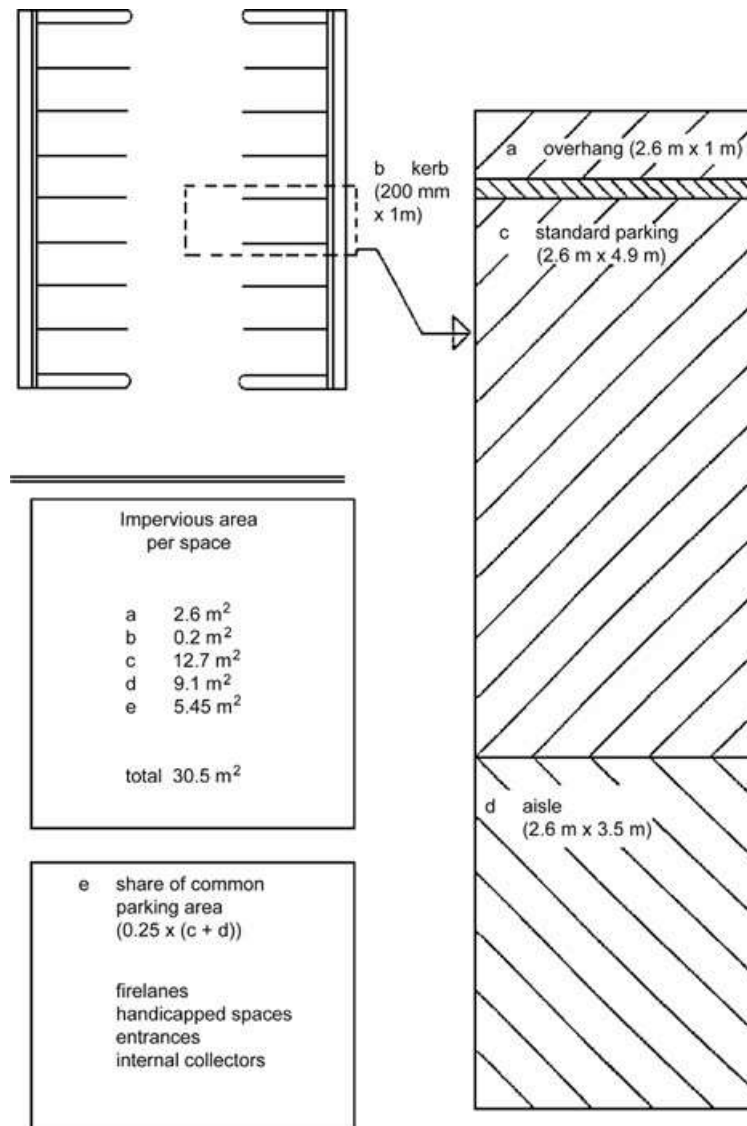

Figure 5-3: Parking area dimensions⁴⁹

A variety of other design-linked techniques should be evaluated, including altered approaches to spillover parking where less areal extent of paving is required (grass, metal, gobi blocks). Another simple technique is one-way angled parking lot configurations, which allow for a reduction in parking aisle widths.

The first parking-related objective of low impact design is to avoid inflated parking ratios. All parking requirements should be revisited, compared with adjacent councils, and compared with actual experience. Ratios such as one space for every 35 square metres of general floor area for offices should be revisited to see if it is necessary or can be adjusted downward. Depending upon the specific use involved, ratios driven by peak demand such as shopping centres may be able to be further reduced if combined with special parking overflow provisions.

Secondly, maximise sharing of parking areas by creative pairing of uses wherever possible. Developers don't attempt such sharing because of the perception that officials would simply reject such a concept. District councils need to incorporate such sharing concepts into their requirements. They should also consider providing positive incentives for developers to utilize sharing options.

5.3.4.5 Driveways

Driveways are very much linked to configuration of the development. Conventional subdivisions have setback requirements as well as front yard/side yard ratio requirements and street

⁴⁹ Delaware Department of Natural Resources and Environmental Control, 1997

frontage requirements. All of these specifications translate into a development mode, which is very familiar and commonplace. Driveway length clearly must be at least equal to the house setback, plus required right-of-way. In addition, as lot sizes become large, setback requirements tend to be well exceeded. Houses often sit considerable distances from the street and driveways become long. As houses have grown larger, car per house ratios have increased with larger and wider driveways again required. A standard four metre wide driveway will fan out into a two or three car garage. There may be additional paving required for out of garage parking. Although reduced density of development on any one site may give the appearance of some improved environmental benefit, the larger site imperviousness expands quickly and any benefit is impacted negatively resulting in more stormwater problems.

Solutions to driveway imperviousness would include reducing their length by locating the house closer to the road; using concrete strips rather than a continuous slab of concrete, or using metal strips as a substitute for concrete entirely. The metal will have a degree of compaction and still have surface runoff but the rougher surface will reduce flow velocities and will require a larger storm to initiate surface runoff than would a concrete driveway.

Twin concrete strip driveway reducing driveway imperviousness



5.3.4.6 Footpaths

Footpaths are an important element in community design and can also be a significant contributor of imperviousness generally being approximately 1.4 metres wide. Although many low-density developments may not need footpaths, they are generally required.

Where they are required it is possible to use more permeable materials or reduce the footpath width and provide less imperviousness to reduce the onset of stormwater runoff.

Dual pathway on one side of a street (in Auckland), increasing site imperviousness



5.3.5 Minimise site disturbance

Minimum site disturbance is an approach to site development where clearing of vegetation and disturbance of soil is carefully limited to a prescribed distance from proposed structures and improvements. In most cases, the concept is appropriate for sites with existing native vegetation, although existing vegetation can also be dune vegetation, pasture grasses, and coastal grasses. Tree cover need not consist solely of stands of mature native vegetation as scrub provides significant quantity and quality benefits as well. An example of a possible approach to minimum site disturbance is shown in Figure 5-4.

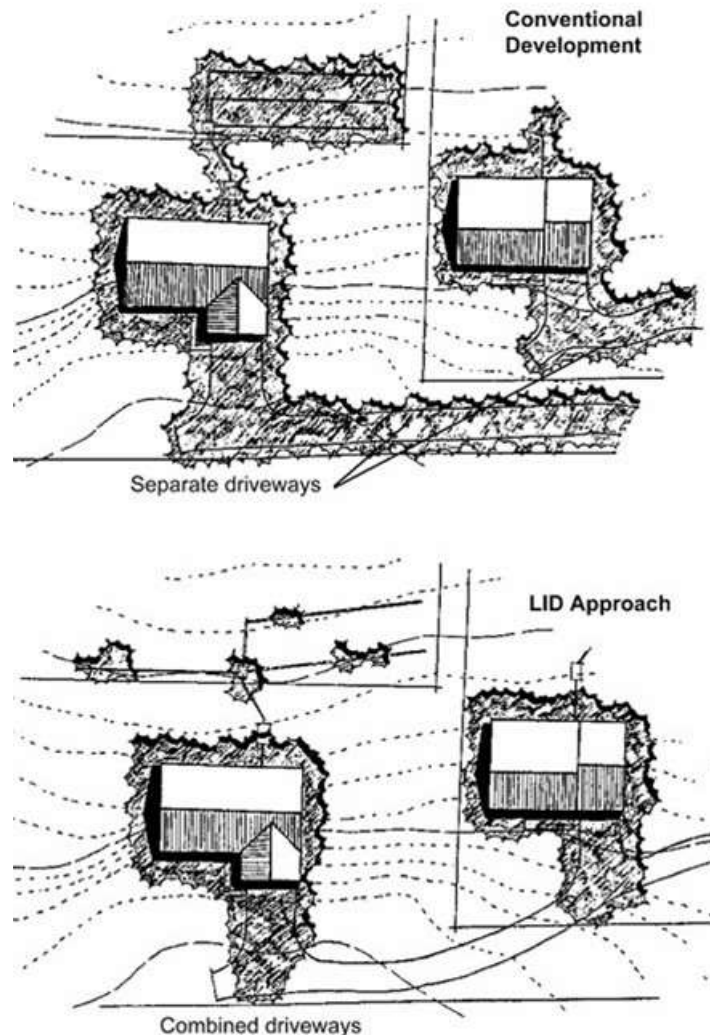

Figure 5-4: Comparison of individual and combined driveways⁵⁰

The objective of minimum site disturbance is to maximise existing vegetation and to minimise creation of an artificial landscape. At issue here are both construction phase impacts as well as the long-term operation of the development. By doing this, not only are the disturbed site impacts avoided as the result of substantial reduction in areas to be disturbed, but also natural areas of vegetation are preserved, retaining all of their functions and ecological values.

The first step in developing a minimum site disturbance programme is to establish a variety of standards and criteria that define the approach, which could include the following:

- Establish a “limit of disturbance” (LOD) based on maximum disturbance zone lengths; such maximum distances should reflect construction techniques and equipment needs, together with the physical situation such as slopes, as well as the building type being proposed. For example, a four metre LOD distance may be workable in low-density residential development, where a ten metre limit may be more appropriate for larger

⁵⁰ Delaware Department of Natural Resources and Environmental Control, 1997

projects where larger equipment use is necessary. LOD distances may be made to vary by type of development, size of site, and specific development features involved. A special exception procedure should be provided to allow for those circumstances with unusual constraints.

- Integrate minimum site disturbance requirements fully into the project review process. Procedurally, the LOD should be established early on in the reviewing process.
- Require the LOD to be staked out in the field for contractor recognition.

In addition, site disturbance can be minimised by locating buildings and roads along existing contours, orienting the major axis of buildings parallel to existing contours, staggering floor levels to adjust to grade changes, allowing for steeper cuts and grades provided that proper stabilisation and erosion and sediment controls are in place, and designing structures including garages to fit into the terrain, lot by lot.

5.4 Cost of low impact design approach

In 2009, the former Auckland Regional Council commissioned a literature review to consider the capital costs of low impact design development versus conventional development. A number of developments in New Zealand and internationally were used to compare relative costs between conventional development and LID approaches to site development.

The findings of this review are provided in the Auckland Council Technical Report 12009/045⁵¹.

The costs of a development depend on an effective, thoughtful design approach but a key outcome is that LID can provide for a more desirable community that incorporates additional amenities and open space, and one that reduces impacts to natural systems generally with no additional construction costs.

Table 5-1 is an excerpt from the Auckland Council study and provides calculated capital costs for a variety of LID development in New Zealand and the United States.

Table 5-1: Comparison of capital costs for LID

Project	Country where Implemented	Conventional Development Costs (\$)	LID Cost (\$)	Cost Differential (\$)	Percent Difference (%)
Heron Point	New Zealand	1,844,000	1,590,000	254,000	14
Palm Heights	New Zealand	7,218,000	5,936,000	1,282,000	18
Wainoni Downs	New Zealand	5,963,000	4,478,000	1,485,000	25
Chapel Run	U.S.A.	2,460,200	888,735	1,571,465	64
Buckingham Green	U.S.A.	541,400	199,692	341,708	63
Tharp Knoll	U.S.A.	561,650	339,715	221,935	39
Pleasant Hill Farm	U.S.A.	1,284,100	728,035	556,085	43
Gap Creek	U.S.A.	4,620,600	3,942,100	678,500	15
Auburn Hills	U.S.A.	2,360,385	1,598,989	761,396	32

The percent difference column shows that for all case studies, the LID approach was less costly in terms of capital costs. The primary reason for the reduced cost is the effect that clustering has on reducing impervious surfaces and reducing the amount of earth working that needs to be undertaken during site development.

There are a number of research papers and studies that compare the lifecycle costs of LID stormwater devices to traditional end of pipe stormwater management devices. The Water New Zealand Stormwater Conference paper entitled '*Understanding and determining the cost of long*

⁵¹ Shaver, 2009

*term maintenance and resilience of WSD*⁵² provides a good summary. This paper states that in general, it has been found that LID devices incur greater costs over their life cycle than traditional end of pipe devices, however the following observations are made:

- Many studies from the UK and USA, as well as some New Zealand theoretical case studies⁵³ show a clear saving of total acquisition costs for LID developments over traditional developments when considering the whole development cost, rather than focusing only on the costs of stormwater management devices.
- The savings in total acquisition costs generally relates to the “avoided costs” of reduced site earthworking, preparation, concreting, and reduced piping rather than the costs of the stormwater management devices themselves.
- There is little on the ground data available regarding maintenance costs in New Zealand for stormwater management devices, this needs to be the focus of further research.
- LID systems are generally more resilient as the risk of device failure is spread across multiple devices rather than one device at the end of the pipe.
- LID approaches are multifunctional (practices provide for more than one function and are intertwined or combined. For example, a park providing stormwater management, amenity values and sport and recreation function).

Overall it is considered that a low impact design approach achieves improved multi-benefit outcomes for a reduced overall capital cost and similar life cycle costs when compared to conventional development approaches.

5.5 Stormwater treatment processes

Stormwater treatment devices attempt a difficult task; the removal of contaminants entrained in stormwater flows. Significant proportions of contaminants dissolve in stormwater and many others are attached to fine particles of silt and clay, which do not easily settle. Processes that reduce contaminant levels include the following:

- Sedimentation
- Aerobic and anaerobic decomposition
- Filtration and adsorption to filter material
- Biological uptake
- Biofiltration
- Flocculation

These processes are discussed individually in the following subsections.

5.5.1 Sedimentation

Most stormwater management programmes in New Zealand and internationally started initially with an intention to mitigate the effects of excess sedimentation into streams and estuaries. The logic was that capture of sediment, while being beneficial, would also provide capture of other contaminants attached to the sediments.

The following tables and figure provide discussion of sediment particle size, contaminants associated with various sized particles, fall velocities for various sediment particle sizes and lastly a representation of how particle size determines whether they can be removed by sedimentation.

The first table, Table 5-2 provides a listing of various particle classes and their sizes.

⁵² Ira et al, 2016

⁵³ Auckland Regional Council, 2000

Table 5-2: Particle characteristics⁵⁴

Size		Class
Millimetres	Microns	
64 - 32		Very coarse gravel
32 - 16		Coarse gravel
16 - 8		Medium gravel
8 - 4		Fine gravel
4 - 2		Very fine gravel
2 - 1	2,000 - 1000	Very coarse sand
1 - 0.5	1,000 - 500	Coarse sand
0.5 - 0.25	500 - 250	Medium sand
0.25 - 0.125	250 - 125	Fine sand
0.125 - 0.062	125 - 62	Very fine sand
	62 - 31	Coarse silt
	31 - 16	Medium silt
	16 - 8	Fine silt
	8 - 4	Very fine silt
	4 - 2	Coarse clay
	2 - 1	Medium clay
	1 - 0.5	Fine clay
	0.5 - 0.24	Very fine clay

Sediment coarser than medium silt settles rapidly, but much longer settling times are required for finer particles to settle. Particles less than 10 µm tend not to settle discretely according to Stokes Law, but exhibit flocculent settling characteristics. Particle shape, density, water viscosity, electrostatic forces, and flow characteristics affect settling rates.

Stokes Law $V_s = 2/9(r^2g(p_p - p_f)/\eta)$

Where:

- V_s = settling velocity (m/s)
- R = particle radius (m)
- G = standard gravity (m/s)
- p_p = particle density (kg/m³)
- p_f = fluid density (kg/m³)
- η = fluid viscosity (pascal-second (pa-s))

Table 5-3 discusses particle size and contaminants associated with them in general stormwater runoff.

Table 5-3: Metals distribution and particle sizes⁵⁵

Particle Size (µm)	Metals Distribution (%)							
	Cd	Co	Cr	Cu	Mn	Ni	Pb	Zn
<10	46	60	71	63	71	63	73	60
10 – 100	36	31	24	30	21	29	23	35
>100	18	9	5	7	8	8	4	5

⁵⁴ Chow, 1964
⁵⁵ Ding et al, 1999

As can be seen, significant portions of the contaminant loads attach to finer sediments. There is variation of the above table by various researchers and better information should be obtained before definitive statements are made. The important point is the trend, which indicates that metals tend to be associated with fine sediments.

Table 5-4 shows particle settling velocities based on Auckland data and includes the proportion of particles in each size category.

Table 5-4: Particle size versus settling velocity⁵⁶

Particle Diameter (µm)	Proportion of Particles (%)	Cumulative Proportion (%)	Particle Density (kg/m ³)	Settling Velocity (m/h)
3	5	5	1100	0.002
6	8	13	1300	0.021
10	5	18	1600	0.118
15	6	24	1900	0.397
20	5	29	1900	0.706
25	4	33	1900	1.102
30	3	36	2150	2.028
50	12	48	2300	6.366
75	19	67	2500	16.524
100	12	79	2650	32.31
150	15	94	2650	67.732
200	5	99	2650	94.086
300	1	100	2650	149.517

Actual settling velocities in the field are often significantly lower than the theoretical values, especially for finer particles. This can be due to turbulence but can also be due to a reduction in settling velocities that occurs the more particles are present. The greater the concentration of suspended sediments, the less the settling velocity can be. Measurements of reductions in settling velocities of 50% and greater have been recorded in high sediment laden water when compared to the same soil particle sizes in clear water. This is not a major factor in permanent stormwater devices but would be a consideration for sediment control ponds.

Figure 5-5 shows sediment particle diameter with the ability to remove various particle sizes with sedimentation.

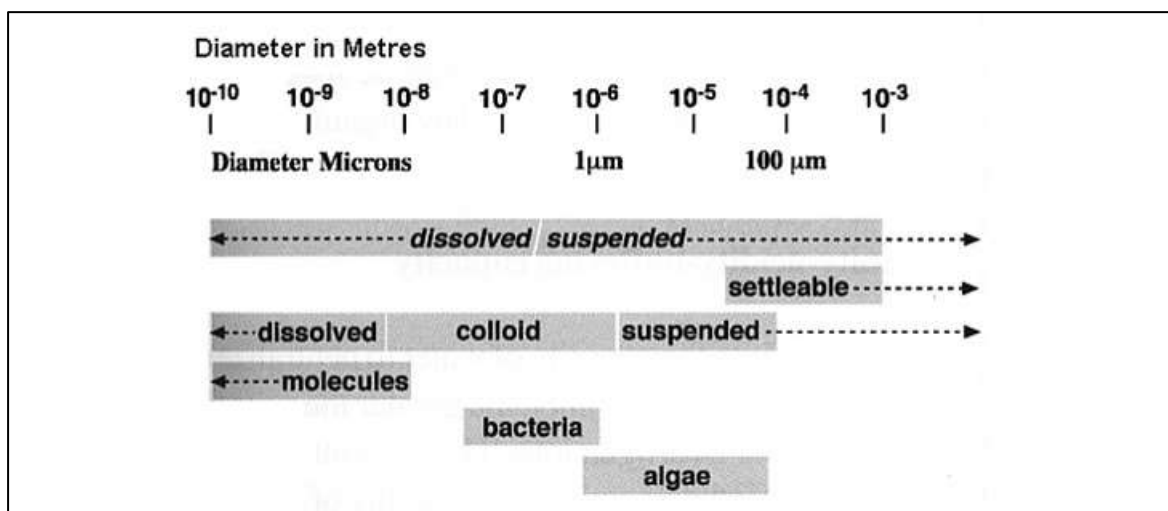

Figure 5-5: Particle size and general classification⁵⁷

⁵⁶ Semadeni-Davis, 2006

⁵⁷ Minton, 2002

As can be seen from the above tables and figure, the ability to use sedimentation as a means of contaminant reduction is limited to larger particle sizes. Depending on the contaminants of concern, removal of suspended solids by sedimentation alone may not remove the contaminants of greatest concern.

It is important to identify the contaminants of greatest concern in order to determine what processes can remove a given contaminant.

Removal of nutrients by sedimentation is not very effective as nitrogen tends to be in a soluble form while phosphorus may be dissolved or attached to sediments. Sedimentation can remove moderate levels of phosphorus but have negligible effect on nitrogen.

5.5.2 Aerobic and anaerobic decomposition

Another process by which contaminants are removed is by microorganisms reducing soluble biological oxygen demand (BOD) and breaking down nutrients and organic compounds by aerobic and anaerobic decomposition. The primary device that uses aerobic and anaerobic decomposition is a wetland.

Once the aerobic microorganisms have taken up contaminants they die and settle to the bottom of ponds where further anaerobic oxidation may take place. In anaerobic conditions, microorganisms can remove nitrogen by de-nitrification. This is an important process in constructed wetland function. Figure 5-6 below shows a simplified wetland nitrogen cycle.

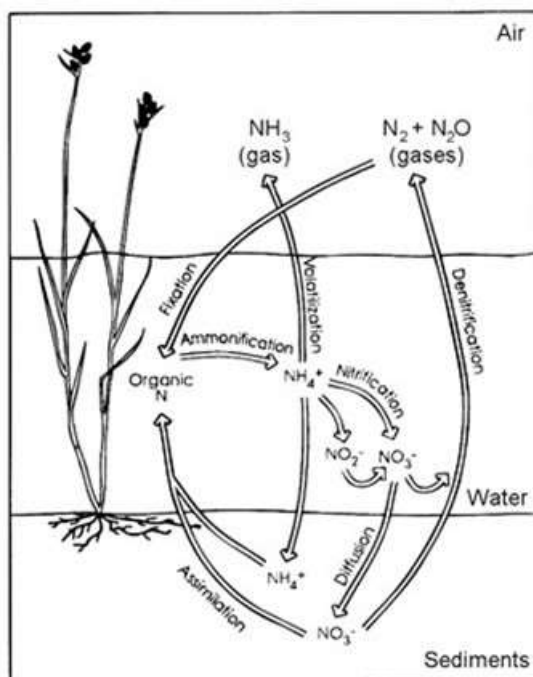

Figure 5-6: Wetland process for denitrification⁵⁸

This process is important when considering areas where nutrient enrichment of receiving systems (primarily lakes) is a problem.

It should be noted that nitrogen is a naturally occurring element that is essential for growth and reproduction in both plants and animals. It tends to be in two forms: organic nitrogen (amino acids that make up proteins or the nucleotides that make up the major part of RNA and DNA), and inorganic nitrogen (occurs in non-carbon containing compounds such as nitrates).

Denitrification is a reduction process where electrons are added to nitrate or nitrite nitrogen, resulting in the production of nitrogen gas, nitrous oxide (N_2O) or nitric oxide (NO). This can only occur when dissolved or free nitrogen is absent. In other words there has to be an anaerobic

⁵⁸ Kadlac et al, 1996

layer at the bottom of the wetland for denitrification to occur. Anaerobic processes are an important mechanism for nitrogen removal.

Nutrient removal in wetlands is not only due to uptake by flourishing plant growth, but also to physical processes such as the adsorption of nutrients to sediments, precipitation and sedimentation.

Plants and sediments are the major accumulators of nutrients in wetlands. Some nutrients such as nitrogen compounds may be converted to nitrogen gas and return to the atmosphere due to the creation of an anaerobic environment. Periodic harvesting of plants may stimulate further plant growth and this may, in turn, enhance further nutrient removal

Having an anaerobic layer develop in a wetland can have other less desirable effects as water can become acidic and mobilise contaminants already captured. If nutrients are not a concern in a given catchment and wetlands are proposed due to their enhanced ability to capture dissolved metals, it is important to maintain an aerobic environment to prevent remobilisation.

5.5.3 Filtration and adsorption to filter material

As sediment particles pass through a filter bed or through soil, the following filtration processes may remove them:

- Settling into crevices
- Enmeshment (entangling) in interstices
- Impingement onto filter particles followed by sticking onto particles (by electrostatic or other bonding)

Filtration has been used for years in wastewater treatment to remove solids from liquids. In the late 1980's filtration was being applied to stormwater treatment, primarily for sediments and oils and grease removal. It functions by interposing a medium to fluid flow through which the fluid can pass, but the solids in the fluid are retained. Its function is determined by the pore size, the thickness of the medium and the live storage elevation above the medium, which drives the fluid through the medium. The path for the fluid to pass through the medium is tortuous and particles are unable to move through the medium.

Adsorption is the accumulation of dissolved substances on the surface of a media such as plants or filters. Dissolved substances can also be removed by adsorption to filter material and biological uptake by microorganisms living among the filter material.

Adsorption is a process that occurs when a liquid solute accumulates on the surface of a solid or forms a film on the surface. It is different from absorption where the substance diffuses into the solid. Atoms of the clean surface experience a bond deficiency and it is favourable for them to bond with whatever happens to be available. Adsorption is a key removal mechanism for dissolved metal reduction in stormwater runoff.

Sand filtration device at a petrol station, recently maintained



5.5.4 Biological uptake

Wetlands and bioretention areas use the interaction of the chemical, physical, and biological processes between soils and water to filter out sediments and constituents from stormwater. They also use interaction of plants to enhance the treatment process. Constituents are first

absorbed, filtered and transformed by the soil and then taken up by the plant roots. Table 5-5 below provides some discussion of contaminant uptake by vegetation.

Table 5-5: Ability of biota to uptake contaminants⁵⁹

Nitrogen	Nitrogen reduction by plants is extremely complicated and depends on the form of nitrogen, pH, growing season, climate, etc. Most of the information available relates to performance of wetland plants with little information on nitrogen uptake by biofiltration systems. Organic nitrogen compounds are a significant fraction of the dry weight of plants.
Phosphorus	Plants require phosphorus for growth and incorporate it in their tissue. The most rapid uptake is by microbiota (bacteria, fungi, algae, etc.) because they grow and multiply at high rates. Phosphorus is a nutrient and its addition stimulates growth.
Metals	Metals reach plants via their fine root structure, and most are intercepted there. Some small amounts may find their way to stems, leaves and rhizomes. Upon root death, some fraction of the metal content may be permanently buried, but there is no data on metal release during root decomposition.

Plants do take up nutrients or metals from stormwater via absorption processes. However they may also re-release them to the water column when they die and decay. An example of this is a swale that is periodically mowed. Unless the grass cuttings are physically removed from the catchment, they will eventually decompose and the contaminants (primarily nutrients) will again be available for transport downstream.

Biological uptake is a less important process in swales, filter strips and rain gardens than it is in wetlands where, for nutrients, it can be an important process as discussed in Section 5.4.2 above.

5.5.5 Biofiltration

A variation to the filtration mechanism is to use plants as the filter media. Biofiltration is a contaminant control technique using living material to capture and biologically degrade and process contaminants. Contaminants adhere to plant surfaces or are absorbed into vegetation. This mechanism is a combination of filtering, reduced settling time and adhesion.

An example of biofiltration is a swale or rain garden where the combination of soils and vegetation provide natural biofiltration. Rain gardens operate by filtering runoff through a soil media prior to discharge into a drainage system. The major contaminant removal pathways are⁶⁰:



- Event processes
 - Sedimentation in the extended detention storage, primary sediments and metals,
 - Filtration by the filter media, fine sediments and colloidal particles, and
 - Nutrient uptake by biofilms.
- Inter-event processes
 - Nutrient adsorption and contaminant decomposition by soil bacteria, and
 - Adsorption of metals and nutrients by filter particles.

⁵⁹ Kadlac et al, 1996

⁶⁰ Somes et al, 2007

The major issues with performance of bioretention as a contaminant reduction device is maintenance of low flow velocities and hydraulic loading during storms too large to permit sedimentation of silts and clays, even with dense vegetation.⁶¹

5.5.6 Flocculation

Flocculation is a process whereby particles join together following the addition of a reagent to form 'flocs', which join together forming larger, heavier particles that settle more rapidly.

Flocculation has been in use in New Zealand for a number of years for erosion and sediment control ponds to improve performance at removal of clay particles. Potential reagents that can be used to encourage flocculation include polyacrylamide, alum and polyaluminium chloride (PAC).

5.6 Summary

This section has discussed an alternative approach to site development that has significant stormwater benefits to the conventional site development approach.

Throughout this guideline there will be emphasis on taking a low impact design approach to site development that incorporates:

1. The use of building materials that do not increase contaminant discharge downstream.
2. Source control via alternative approaches to site development that reduce the generation of stormwater runoff at-source.
3. Use of natural drainage systems such as swales or filter strips to the degree that they can be incorporated.
4. The use of stormwater devices to provide an overlay to the first three items, as needed.

In addition, the various processes that provide stormwater treatment options have been presented so that a variety of approaches can be considered on a site-by-site basis depending on stormwater related issues.

It is expected that stormwater designers will consider the various approaches to design and not just go with the approach that maximises site development potential. More detail will be provided in later sections on specific criteria that enable the implementation of the approaches listed above.

⁶¹ Mazer et al, 2001

Part II: Stormwater management design

6 Choosing a stormwater management approach

There are two aspects to selection of a stormwater management approach for a given site:

- Regulatory and design requirements, and
- Individual device suitability.

Both of these aspects are discussed in the following sections.

6.1 Regulatory and design requirements

The Regional Policy Statement states that the regional council promotes low impact options while the Regional Plan provides flexibility for the pursuit of low impact design as a component of an urban stormwater discharge strategy. As such, the key element of these guidelines is to provide a framework that facilitates the transition of traditional development to one that provides greater protection of aquatic resources whilst still facilitating development.

6.1.1 Design responsibility

Design for stormwater management shall be undertaken by individuals with the appropriate technical background and experience in stormwater management to undertake the design. This will generally be a stormwater engineer with more than five years of experience.

6.1.2 Information requirements

The following information must be investigated and incorporated into development design to the degree possible in a design report that accompanies the consent application.

1. General context information:
 - a) The surrounding land context (rural, urban, vegetation, etc.)
 - b) The site location within a catchment
 - c) Site size
 - d) Structure plan, district plan, catchment consent requirements
2. Ancillary benefits considered:
 - a) Urban design elements
 - b) Crime prevention through environmental design
 - c) Energy efficiency
 - d) Ecology
 - e) Landscape amenity
3. Site natural features:
 - a) Wetlands
 - b) Streams (including ephemeral streams)
 - c) Floodplains
 - d) Gullies
 - e) Riparian buffers
 - f) Existing site vegetative cover
 - g) Soils
 - h) Depth to groundwater
 - i) Slopes - highlighting steep ones (greater than 33%)
 - j) Other natural site features
 - k) Cultural or archaeological features
4. Receiving environment factors considered:
 - a) Tidewater or coastal discharge points?
 - b) Downstream flooding problems
 - c) Recognised downstream sensitive areas

- d) Site streams including ephemeral streams
 - e) Ground conditions if site is to drain to ground
5. Hydrological factors:
- a) Route taken by stormwater runoff from the source to the receiving environment
 - b) Erosion potential of drainage path
 - c) Potential steps to reduce overall stormwater runoff volume
 - d) Revegetation potential to reduce stormwater runoff
 - e) Connection of impervious surfaces to receiving systems
6. Stormwater issues related to the receiving environments from Table 4-3.
7. Building programme considerations:
- a) Public sewer availability
 - b) Public water availability
 - c) Total number of site units – can the areal extent be reduced
 - d) Type of units
 - e) Lot density flexibility
 - f) Individual lot flexibility
8. Lot configuration consideration:
- a) Potential for lot size reduction
 - b) Potential for clustering
 - c) Natural features protection potential
9. Impervious surface reduction considerations:
- a) Potential for road lengths and widths to be reduced
 - b) Potential for driveway lengths and widths to be reduced
 - c) Potential for shared driveways or parking spaces
 - d) Potential for parking ratios and parking sizes to be reduced
 - e) Potential for cul-de-sacs and roundabouts to reduce imperviousness
 - f) Potential to reduce kerbing or provide kerb cuts
10. Site disturbance minimisation:
- a) Site disturbance footprint and potential to reduce disturbed area
 - b) Important natural, cultural or archaeological features to be protected
 - c) Potential to maximise open space
 - d) Structure design compatibility with site features
 - e) Revegetation potential
11. Design calculations:
- a) Have curve numbers or 'c' factors been reduced as much as possible?
 - b) Has runoff volume been reduced as much as possible?
 - c) Has pre-development time of concentration been maintained?
12. Mitigation alternatives:
- a) Integration of stormwater management into overall site plan
 - b) Prevention minimisation prior to mitigation
 - c) Have vegetative stormwater management practices been used to the degree possible?
 - d) Can unpreventable impacts be mitigated through conventional stormwater management practices?
13. Long term operational considerations:
- a) Has responsibility for maintenance been assigned and accepted?
 - b) Have whole of life costs been incorporated into stormwater management approach?

6.1.3 Low impact design scoring approach

Information contained in the report shall also include a low impact design scoring matrix for which the summation provides an overall score of the design. The scoring is based on Table 6-1.

Table 6-1: Low impact design scoring matrix

Implementation elements	Typical components	Scoring details	Score
Source control maximised	Water re-use	0-4 depending on % of total roof runoff captured	
	Site disturbance reduced from a conventional development approach	0-3 depending on reduction as % of total site area	
	Impervious surfaces reduced from a traditional approach	0-3 depending on reduction as % of total site area	
	Use of building or site materials that do not contaminate	0 or 1 for residential 0-3 for commercial or industrial	
	Existing streams and gullies located on site (including ephemeral) are protected and enhanced. The entire stream other than possible crossings shall be protected to qualify for points.	0-3	
	Riparian corridors are protected, enhanced or created	0-3	
	Protection and future preservation of existing native bush areas	0-2 depending on percentage of site area	
LID stormwater device/practice used	Infiltration devices to reduce runoff volume	0-6 depending on % of runoff capture	
	Revegetation of open space areas as bush	0-3 depending on % of site covered	
	Bioretention	0-6 depending on % of runoff capture	
	Swales and filter strips	0-3 depending on % of runoff capture	
	Tree pits	0-6 depending on % of runoff capture	
	Constructed wetlands	0-4 depending on % of runoff capture	
Traditional mitigation	Wet ponds	0-1 depending on % of runoff capture	
	Proprietary devices	0-1 depending on % of runoff capture	
	Dry detention ponds	0	
Urban design	Stormwater management is designed to be an integral and well considered part of the urban design.	0-2	
Tangata whenua values	Stormwater management has been designed considering Tangata Whenua values and demonstrates that these have been incorporated into the design	0-2	
Total score			

The scoring matrix outlined above relates to stormwater management and focusses on encouraging LID in particular. This doesn't replace the need to consider other values including cultural, social, environmental and economic.

Whilst a number of the items outlined in the matrix are outside the scope of what is consented by the Waikato Regional Council, and relate to land use hence are under the jurisdiction of territorial authorities, it is important to consider how stormwater can be managed holistically irrespective of jurisdictions.

Once the total score is calculated, the minimum score in terms of acceptability is shown in Table 6-2 and Table 6-3 below. Scores lower than those shown will have to justify rejection for those items not incorporated.

Table 6-2 shows the minimum target scores for the two main elements of the scoring matrix: source control and the inclusion of low impact design devices/practices within the proposed development. The target scores vary depending on whether there are existing natural features that need to be protected and what the design criteria are for the site.

Table 6-2: Target scores (excluding highway projects)

Design criteria for the site	Existing natural features to protect			No existing natural features to protect		
	Source control target	LID devices target	Total target	Source control target	LID devices target	Total target
<ul style="list-style-type: none"> Water quality treatment required Peak flow control required Volume control required 	6	6	15	4	6	12
<ul style="list-style-type: none"> Water quality treatment required Peak flow control required 	6	4	13	4	4	10
<ul style="list-style-type: none"> Water quality treatment required Volume control required 	6	3	12	4	3	9
<ul style="list-style-type: none"> Water quality treatment required 	6	2	11	4	2	8

Highway projects are different from normal development projects and the ability to provide source control is limited. Highway projects must still consider LID and traditional mitigation devices and must achieve a score according to Table 6-3.

Table 6-3: Target scores for highway projects

Design criteria for the site	Existing natural features to protect	
	Yes	No
<ul style="list-style-type: none"> Water quality treatment required Peak flow control required Volume control required 	8	6
<ul style="list-style-type: none"> Water quality treatment required Peak flow control required 	6	4
<ul style="list-style-type: none"> Water quality treatment required Volume control required 	6	4
<ul style="list-style-type: none"> Water quality treatment required 	4	3

Waikato Regional Council recommends that stormwater management systems are located in public spaces (carriageways, drainage reserves, public open spaces) and that they are vested to territorial authorities to ensure that ongoing management of the systems is assured.

As stated in Section 1, the Waikato Regional Council uses a Best Practicable Option (BPO) approach for assessing the adequacy of technical design for discharge consents. As such, being unable or unwilling to meet the thresholds indicated above does not automatically mean the consent application will be declined. If an applicant chooses to use another approach to site development then an analysis should accompany the application to demonstrate that similar outcomes are achieved when compared to if a low impact design approach was taken.

6.1.3.1 Scoring matrix values

It is important to provide a consistent approach to selecting values for each category component. The following subsections provide scoring values for each component so that the values selected are not arbitrary.

Source control

1. Water re-use
 - Flow detention only is 1 point.
 - Site use for garden watering is 2 points.
 - Site use for garden watering and for non-potable inside waters uses including laundry and toilets is 3 points.
 - Site use for full water supply is 4 points
2. Site disturbance reduced from a conventional development approach
 - 10 % reduction from a conventional development is 2 points.
 - 20% and greater reduction from conventional development is 3 points
3. Impervious surfaces reduced from a conventional development approach
 - 5% reduction is 2 points.
 - 10% reduction is 3 points.
4. Use of building or site materials that do not contaminate
 - Residential roofs, gutters, down spouts made of non-contaminant leaching materials is 1 point.
 - Commercial roof, gutters, down spouts made of non-contaminant leaching materials is 3 points.
5. Existing streams and gullies (including ephemeral streams) are protected and enhanced
 - Preservation and protection of natural streams and gullies is 3 points.
6. Riparian corridors are protected, enhanced or created
 - Riparian corridor protection scores depend on the width of corridor provided. 5 metres on either side of the stream is 1 point, 10 metres is 2 points and greater than 10 metres is 3 points.
7. Protection and future preservation of existing native bush areas
 - Protection, preservation and, if needed, enhancement of native bush areas that exceed 10% of the site is given 2 points.

LID stormwater devices/practices used

1. Infiltration devices to reduce runoff volume
 - Meeting the capture and infiltration requirements of the initial abstraction volume is given 2 points.
 - Meeting the capture and infiltration requirements for the site water quality storm is given 3 points.
 - Meeting the capture and infiltration requirements for the 2-year ARI event for the site is given 6 points.
2. Revegetation of open areas as bush

- Planting open space and providing maintenance of planting for 3 years if open space is equal to or exceeds 10% of overall site area is given 3 points.
3. Bioretention (including tree pits)
 - Meeting the capture and retention requirements of the initial abstraction volume is given 2 points.
 - Meeting the capture and retention requirements for the site water quality storm is given 3 points.
 - Meeting the capture and retention requirements for the 2-year storm for the site is given 6 points.
 4. Swales and filter strips
 - All impervious surfaces draining to swales and filter strips that have capacity for treating and conveying the water quality event is given 2 points.
 - All impervious surfaces draining to swales and filter strips that have capacity for treating the water quality event and conveying the 2-year ARI event is given 3 points.
 5. Constructed wetlands
 - Meeting the water quality design storm criteria is given 2 points.
 - Meeting extended detention and peak control requirements is given an additional 2 points.

Traditional mitigation

1. Wet ponds
 - Use of a wet pond for stormwater quantity control and stream channel protection is 1 point.
2. Proprietary devices
 - Meeting water quality requirements using council accepted proprietary devices is given 1 point.
3. Dry detention ponds
 - As this device provides negligible water quality benefit, and generally has poor operation and performance in the long term, use of the device for quantity control is given 0 points.

Urban design

1. Stormwater management is designed to be an integral and well considered part of the urban design. 2 points can be obtained by demonstrating, in a narrative, how the site design incorporated LID principles into the overall site design.

Tangata whenua values

1. Stormwater management has been designed considering tangata whenua values and demonstrates that these have been incorporated into the design. 2 points can be obtained by demonstrating, in a narrative and with design components, how the stormwater management system incorporates tangata whenua values.

There will be situations in the source control and low impact design categories where the entire site cannot have a given device / practice or where a given category cannot achieve the level of coverage that point scores are based upon. In those situations, a pro-rata score can be achieved based on the percentage of coverage.

As an example, revegetation of open areas as bush that exceeds 10% of site area is awarded 3 points. If there is only space available for achieving 5% of site coverage, then using a pro-rata approach will allow for the award of 1.5 points for revegetation. A similar approach may be used for other items to determine an overall site score.

6.1.3.2 Application of the low impact design scoring matrix

The overall development process requires initial steps of site data collection in conjunction with consideration of the type of development intended at a given location. As the information is gathered decisions start to be made regarding the shape, form and overall approach to site development, which determines the stormwater management approach.

The process requires a different approach or paradigm shift for conventional site design in that stormwater related issues must be addressed at the initial design phase of project development. This has historically not been the approach and stormwater related issues have tended to be considered during the final stages of site design.

This paradigm shift is necessary if downstream resources and properties are to be protected when land use change in upstream catchment areas is undertaken. The historic approach relied completely on capture and treatment of stormwater runoff while the current approach requires consideration of source reduction of runoff prior to any consideration of capture and treatment.

Reducing the volume of stormwater runoff is of critical importance if goals of environmental protection can be realised. This paradigm shift of how stormwater is managed is also required to ensure that the objectives of the Vision and Strategy for the Waikato River are achieved (and future legislation for other rivers in the region) and that objectives of co-management partnerships with Iwi are recognised.

The following simplistic flowchart shown in Figure 6-1 below considers the design process and illustrates how consideration of stormwater management should be embedded into the overall development process. Failure to address stormwater management early in the design process will likely result in a failure to achieve the required environmental outcomes.

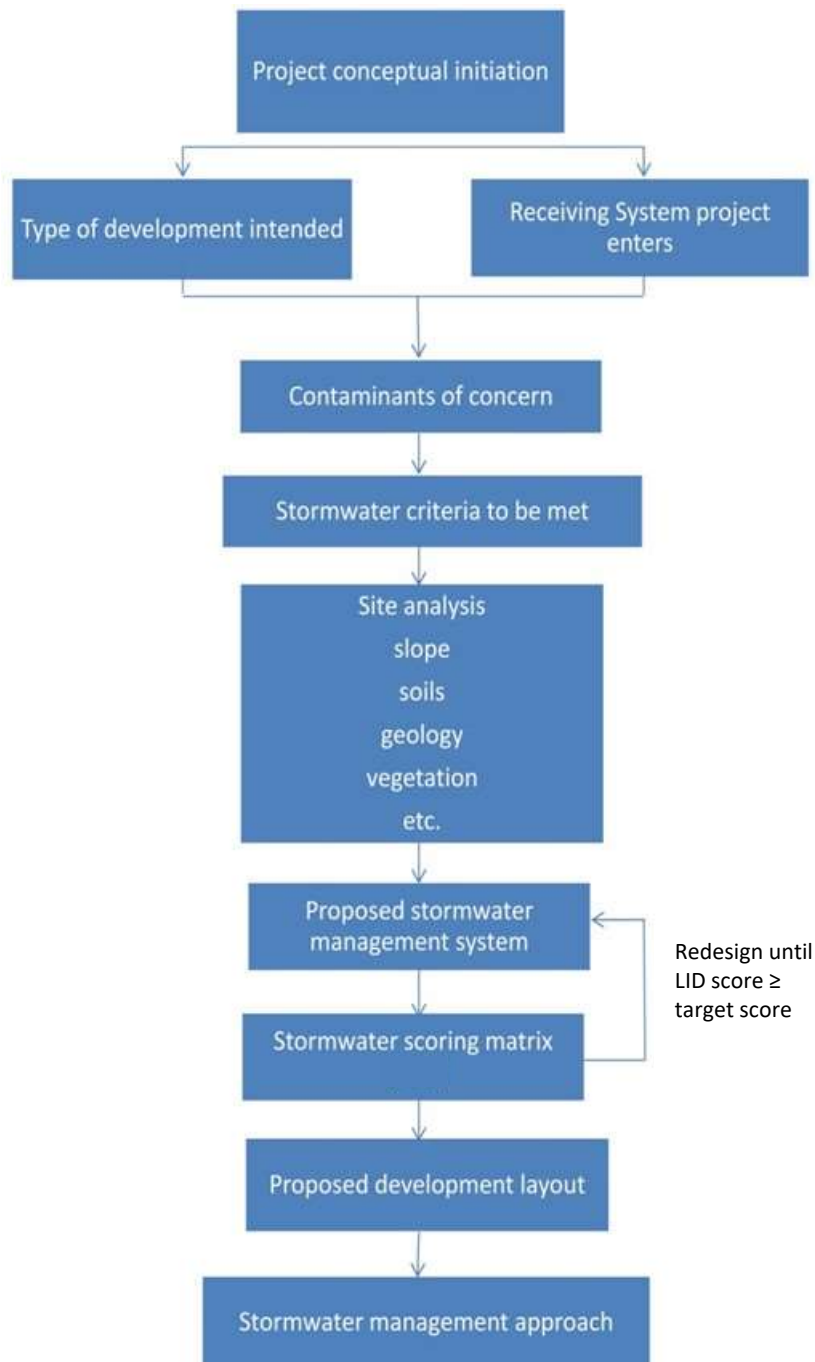

Figure 6-1: Development process and stormwater management design

6.1.3.3 Case study – Low impact design scoring matrix

A residential site outside of Hamilton is approximately 16 ha in size with approximately 8.8 ha of bush and 7.2 ha of pasture as shown in Figure 6-2.

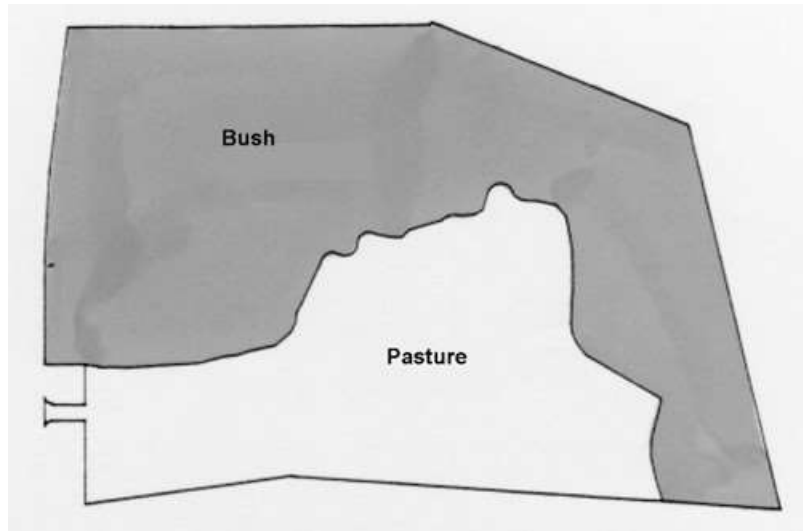

Figure 6-2: Pre-development site showing land use

The site design plan approach would have 142 lots, each being 800 m² in size. The site would be approximately 70% impervious when including roads, footpaths, roof areas and driveways. The conventional development site plan is shown in Figure 6-3. Stormwater management is provided by stormwater management wetland ponds at several locations around the property due to site grades. Overall site disturbance is 100% and water re-use for garden, toilet and laundry will be provided.

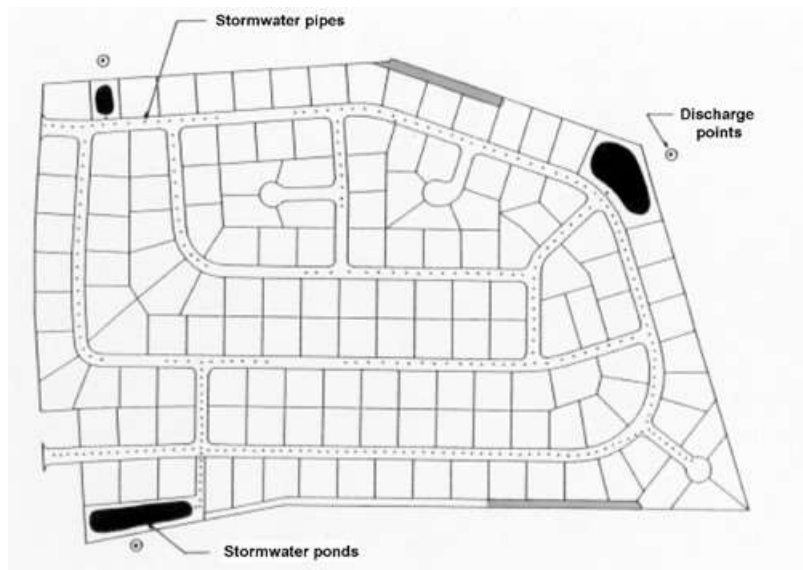

Figure 6-3: Conventional site development

One possible low impact design approach would have the same number of lots but those lots would be 400 m² in size with an overall site imperviousness being approximately 37%. The low impact design approach is shown in Figure 6-4 with stormwater management being provided through the use of various infiltration devices. The overall site area being disturbed is 9.3 ha and water re-use for garden, toilet and laundry will be provided.

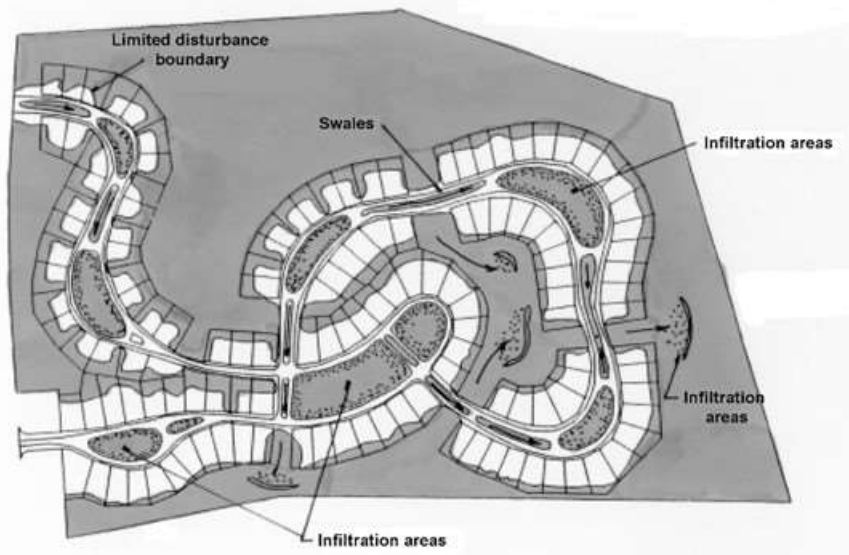

Figure 6-4: Low impact design approach

Using the scoring matrix to determine the number of points that the redesign receives gives the following:

1. Water re-use – conventional receives 2 points and LID approach also receives 2 points.
2. Site disturbance reduced from a conventional approach – conventional receives 0 points and LID approach receives 3 points for over 40% reduction in site disturbance.
3. Impervious surface reduction – conventional approach has 11.2 ha of impervious surface while LID approach has 5.92 ha of impervious surface or almost a 50% reduction so the LID approach receives 3 points.
4. Building or site materials – both sites would probably receive 1 point.
5. Existing streams or gully protection – there are no streams or gullies so no points can be obtained.
6. Protection of native bush – approximately 8 ha of native bush is preserved, which is roughly 50% of the site so the LID approach receives 2 points.
7. Infiltration devices to reduce runoff volume – conventional development relies on reticulation while LID approach controls storms up to and including the 2-year storm and the LID approach receives 6 points.
8. Revegetation – neither site uses revegetation.
9. Bioretention – neither site uses bioretention.
10. Swales and filter strips – the LID approach uses swales and filter strips to transport runoff to the infiltration devices so the LID approach is given 3 points.
11. Constructed wetlands – conventional approach may use wetlands for their three ponds so it would receive 4 points for peak flow control and water quality design. LID approach does not need to use ponds so no points are earned.
12. Wet ponds – since wetlands are the preferred approach for the conventional approach no points are earned for using wet ponds.
13. Proprietary devices – none used for either approach so no points given.
14. Detention ponds – none used for either approach.
15. Urban design – site incorporates a high level of LID features into the overall development proposal – scores 2 points.
16. Proposal provides protection of existing native bush area and incorporates soakage of stormwater to ground hence is in keeping with tangata whenua values – scores 2 points.

Total points given:

- Conventional approach is given 7 points.
- LID approach is given 24 points

The LID approach exceeds the minimum required points (15) by having 24 points. The conventional approach only receives 7 points so modifying the design should be undertaken to increase the number of points that can be given.

While the actual example may be considered extreme from an LID perspective, it shows that development can be accomplished while using LID approaches. The LID example exceeded the minimum requirements fairly easily and also exceeded the percentage minimums in every situation. Projects could have less drastic redesign and still meet the required minimum score.

The major point is that the approach to development must evolve if aquatic and terrestrial resources are to be protected and enhanced.

6.2 Individual device suitability

Stormwater management devices normally provide water quantity control, water quality control or sometimes both. It is important to recognise that stormwater management devices do not perform equally in all situations. A device using infiltration of runoff as the method of choice is not going to function in soils with limited permeability rates. In the same regard, a device such as a stormwater management pond may be good at removal of suspended solids but provide little benefit for dissolved metals reduction.

It is important to recognise the potential effectiveness of different stormwater devices on the contaminants generated at a specific site and for a given receiving environment. Consideration must be given to contaminants of concern and stormwater management devices appropriate to remove those contaminants.

6.2.1 Site considerations

The success of any management approach depends on selecting the appropriate options for the sites control objectives and conditions at an early stage. The objectives must be defined at the outset and site conditions investigated in enough detail to match the approach to the site to meet the objectives. Decisions need to be made as to whether quantity control, quality control or ecosystem protection or enhancement are required and which contaminants need to be treated and how.

Deciding whether a stormwater management device is relevant means looking at the following issues:

- Soils in the location of the intended stormwater management device
- Slopes
- Catchment area draining to individual devices, and
- General constraints.

The following sections discuss each of these items in more detail.

6.2.1.1 Soils

Underlying soils are very important to determine whether a given stormwater management device will function as intended. More permeable soils can enhance the operation of some devices, but adversely affect the performance of others. As an example, a constructed wetland may not retain water if the underlying soils are highly permeable, and hence would need to be lined to maintain minimum water levels and the health of wetland plants in this circumstance.

On the other hand infiltration devices rely on passage of water through the soil profile, and more permeable soils transmit greater volumes of water. Having poor permeability in subsoils would preclude the use of infiltration for a given area.

From a general context, the following Table 6-4 provides a discussion of various soils and their approximate infiltration rate and the red line indicates the minimum rate for using infiltration.

Table 6-4: Infiltration rate for various soil textural classes

Texture Class	Approximate Infiltration Rate in mm/hour
Sand	210
Loamy sand	61
Sandy loam	26
Loam	13
Silt loam	7
Sandy clay loam	4.5
Clay loam	2.5
Silty clay loam	1.5
Sandy clay	1.3
Silty clay	1.0
Clay	0.5

The location of the red line in the table indicates a normal minimum permeability limit for when infiltration devices are suitable for a given site. If the infiltration tests indicate an infiltration rate of less than 7 mm/hour then infiltration is not normally considered appropriate due to the silty nature of the soils.

Table 6-5 provides a view of devices and their suitability for various soil textures.

Table 6-5: Soil and suitability of various stormwater management devices

Ponds/ Wetlands					
Sand Filters					
Rain Gardens					
Infiltration					
Swales/Filter strips					
	Sand	Loam	Silty Clay	Clay	
Blue colour denotes acceptable device range related to soil types					

There may be confusion over what a loam soil is. Loam is soil that is composed of sand, silt and clay in relatively even concentration (approximately 40-40-20% respectively). Loam soil contains the right amount of sand, silt, clay and organic material. It is known as a “garden soil” that is good for plants. They generally contain more nutrients than do sandy soils. Silty loam is generally considered as the soil having the minimum permeability rates for use of infiltration. Loamy soil is also commonly recommended for use in rain gardens.

6.2.1.2 Slopes

Slope is important when selecting a stormwater management device. Steeper slopes may:

- Eliminate some devices from consideration, or
- Require devices to be modified from a more desired approach.

Stormwater management devices that rely on storage of water have slope limitations as adequate storage may necessitate significant cut and fill to meet storage requirements.

Figure 6-5 below shows how slope steepness impacts storage ability of a pond. The same analogy applies to filter systems that have a live storage requirement.

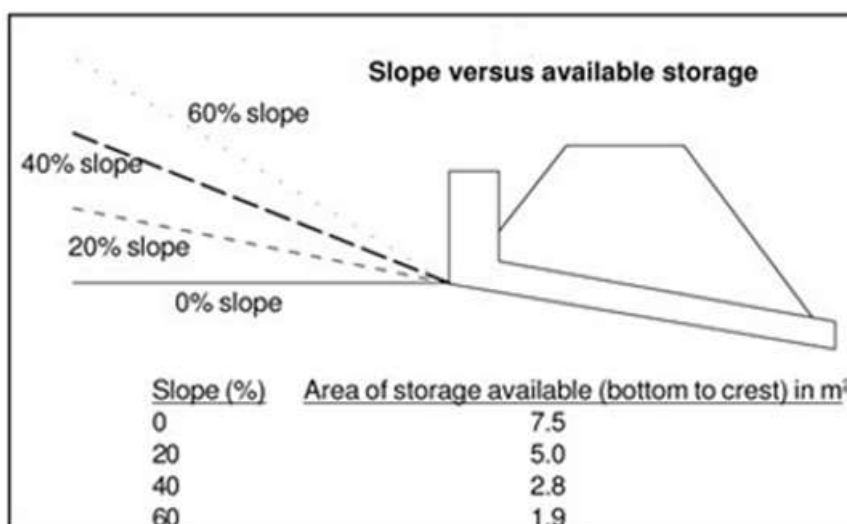

Figure 6-5: Slope versus available storage⁶²

Other devices, such as vegetated swales may be adapted for steeper slopes if the swales are placed along the contours, rather than up or down slopes. The ability to manipulate direction of swales is limited and slope may well determine whether swales or filter strips can be used on a given project. Swales and filter strips are normally limited to approximately a 5% slope to ensure that adequate residence time is provided for significant contaminant reduction and to ensure that flow velocities do not cause erosion.

The following Table 6-6 provides some discussion of stormwater management device and their limitations related to slope.

Table 6-6: Slope limitations of various stormwater management devices

Practice	Slope Limitation
Ponds/Wetlands	As the slope increases the amount of cuts and/or fills increases. Ponds generally are not suitable on slopes > 10%.
Sand Filters	Sand filters can either be pre-fabricated units or constructed in place. For prefabricated units, generally live storage can be provided within the unit so slope is not a critical issue. For open systems, the slope problems are similar to ponds or rain gardens.
Rain Gardens	Similarly to ponds, live storage is a problem on steeper slopes. The surface of the rain garden has to be level to ensure an even flow through the media.
Infiltration	Infiltration devices are not recommended on steeper slopes or on fill slopes. There is a potential for slope instability with seepage coming out on the slope below the device or for lateral flow to occur at the natural ground/fill interface. Infiltration should only be used when a geotechnical engineer certifies it as an appropriate use.
Swales/Filter strips	Not suitable for slopes > 5% unless check dams flatten overall slope

6.2.1.3 Catchment area

Catchment area is another key element that determines the suitability of a stormwater management device at a specific site. Some devices, due to treatment or hydrological factors are more appropriate to smaller or larger catchment areas. Devices that rely on vegetative or filter media filtering of runoff are more appropriate for smaller catchment areas, as large flows may overwhelm their ability to filter the runoff. Ponds, on the other hand, are more appropriate

⁶² Auckland Regional Council, 2003

for larger catchment areas.⁶³ The following Table 6-7 provides guidance for stormwater management devices and associated catchment areas.

Table 6-7: Stormwater management devices related to catchment areas

Stormwater management device											Controlling factor for use
Ponds											Catchment area to maintain normal pool of water
Wetlands											Catchment area to maintain hydric soils
Sand filters											Volume of runoff
Rain gardens											Volume of runoff
Infiltration											Soils, slope, stability, etc.
Swales and filter strips											Rate of runoff and slope
0 2 4 6 8 10 12 14 20 40 (in hectares)											
<div style="display: flex; justify-content: space-around; align-items: center;"> Suitable for use Marginal for use </div>											

6.2.2 General constraints

There are a number of other constraints that may limit a given device from being used on a specific site. Those items can include the following issues:

- High groundwater table and potential mounding
- Proximity to bedrock
- Slope stability
- Space availability
- Maximum depth limits
- High sediment input
- Thermal effects, especially from wet ponds, and
- Cost.

Discussion about these constraints is provided in the following subsections.

6.2.2.1 High groundwater table and potential mounding

Having a high groundwater table can preclude the use of a number of devices. Figure 6-6 shows a typical schematic of ground surface and groundwater level. Seasonally there can be a wide variation in groundwater levels and that difference can be in excess of a metre depending on the time of year.



Figure 6-6: Groundwater schematic⁶⁴

⁶³ ARC, 2003

⁶⁴ Maryland Department of Natural Resources, 1984

Devices that need to be cognisant of groundwater levels in terms of their location and applicability include:

- Ponds and wetlands
- Infiltration devices, and
- Swales.

Filter systems can generally be designed around site conditions as long as there is a positive outfall.

Groundwater mounding can also be a concern. This is particularly relevant for infiltration devices, where significant surface runoff soaks to ground in one location and then elevates local groundwater levels. This concept is shown in Figure 6-7 below.

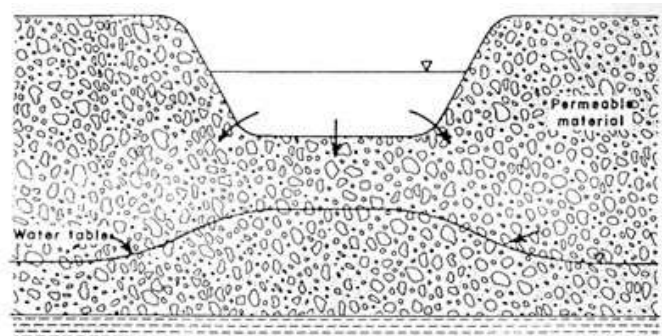

Figure 6-7: Groundwater mounding under an infiltration practice⁶⁴

Even though pre-development groundwater levels may be low enough that site development concerns shouldn't result, the artificial raising of local groundwater levels could cause performance problems.

6.2.2.2 Proximity to bedrock

Proximity to bedrock has two major issues: drainage in a similar fashion that infiltration devices have with groundwater levels, and cost to construct a device if the invert requires excavation into bedrock. Either of these two issues could adversely impact the use of a given device and it could apply to any device depending on the depth to bedrock.

6.2.2.3 Slope stability

The use of a stormwater device on a slope can increase slope stability issues. If incorrectly designed, the stormwater discharge from the device can exit the slope above the toe of the slope, as shown in Figure 6-8 below.

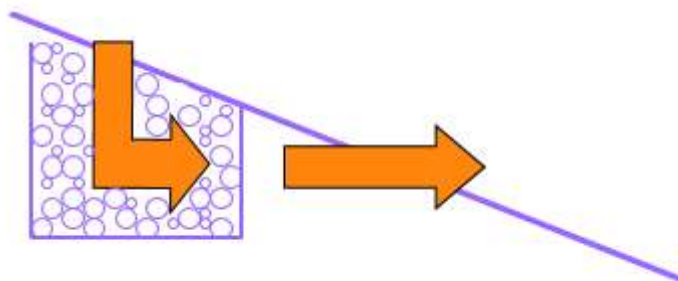

Figure 6-8: Slope and seepage from an infiltration trench

This discharge above the toe can increase the saturation of the slope or cause overland flow across the slope to occur where it previously didn't, hence potentially causing adverse stability effects.

This applies to infiltration primarily but could also apply to rain gardens and swales if they discharge to the top of a steep slope. Using a device on a slope that may not have existing stability issues and then artificially putting water in the soil could cause stability concerns. Geotechnical reports are essential if there is an intention to place stormwater flows in the ground on slopes.

6.2.2.4 Space availability

In general, space allocated for stormwater management is always going to be limited as development potential is maximised. There may be situations where regulatory requirements and downstream impacts may necessitate acquiring additional land however, for the most part, devices will have to fit within a given limited site area that is available for stormwater management.

From a water quantity perspective there may be opportunities to be creative, such as under sizing pipes conveying catchment drainage and using road embankments to control water quantity discharges downstream. Water quality will still be necessary, as larger catchment flows would necessitate larger treatment devices.

Those devices having the greatest area requirements are wetlands and ponds. These devices are generally more appropriate for larger catchments and larger footprints.

6.2.2.5 Maximum depth limits

There will be situations, especially where there are reticulation systems, when the invert of the receiving system pipe will determine the invert of the stormwater management device. If the invert of the receiving pipe is above the invert of the stormwater management device then the device will not drain and could cause localised flooding or system bypass.

There has to be a positive outfall from stormwater management devices if they are to function for peak control or water quality treatment.

6.2.2.6 High sediment inputs

A number of stormwater management devices are sensitive to excess sediment loadings and will incur maintenance problems if catchment sediment loads draining to the individual device are high. Examples of this situation would be areas adjacent to a treatment device undergoing earthworks and having high sediment loads entering the treatment system. Another situation could involve horticultural activities where seasonal land clearing and planting could increase sediment runoff to treatment devices.

Device that are sensitive to high sediment loadings that will have a fairly rapid decline in water quality treatment performance include the following:

- Infiltration devices
- Sand filters
- Rain gardens
- Swales, and
- Filter strips.

Ponds and wetlands, having sediment forebays, have the ability to store larger sediment loads than the other devices, although they still would require more frequent maintenance to maintain performance.

Prematurely clogged rain garden from un-stabilised adjacent areas



6.2.2.7 Thermal effects

Water temperature affects water chemistry and quality, and has a pervasive, over-riding influence on the receiving system biota through its control of enzyme systems and the

physiology of cold-blooded animals. Water temperature is therefore a key factor influencing the ecological performance of streams. Summer is the main time of year when thermal enrichment issues occur.

Pavement modifies stormwater temperatures, raising it during the summer, but cooling it in cold winter months. A study undertaken in the U.S.⁶⁵ observed during one summer storm that the temperature of the stormwater from a parking lot was 5°C higher than the rainwater.

From a New Zealand context, acute mortality for most native NZ fauna tested to date occurred above 25°C. LT₅₀ values (lethal temperatures that killed 50% of the test organisms over a 10-minute duration) for nine species of native fish ranged from 27.0-31.9°C.⁶⁶ Juvenile and adult eels were considerably more tolerant than other fish species (LT₅₀ ranges from 34.8-39.7°C) and thus were not used in setting assessment criteria. Native invertebrate species were more sensitive than fish, where LT₅₀ values (24-hour exposure) for 12 species ranged from 25.9-32.4°C.⁶⁷ One study⁶⁸ recommended that a maximum value of 3°C below the lowest LT₅₀ would allow for a margin of safety. Based upon the test data and interpretations, slight, moderate and severe adverse effects were estimated to occur above 22°C, 24°C and 26°C, respectively.

There are three possible sources of temperature increase from urban land uses: impervious surfaces, standing water in stormwater ponds and the elimination of stream shading. Temperature increases from pavements are mentioned above but stormwater ponds could increase thermal loadings to receiving systems. Ponds may have degraded water quality due to temperature increases, as their surface area tends to be exposed to direct sunlight. As a result, ponds can cause significant adverse effects on downstream macroinvertebrate communities.⁶⁹

There are ways to reduce these thermal impacts including if the ponds:

- Are not located in stream channels
- Have below surface outfalls (temperatures are greatest at the surface)
- Have a piped outlet that enables discharges to be cooled by heat transfer to the adjacent ground surrounding the outlet pipe, and
- Are small enough that riparian vegetation could provide shading of the pond surface.

Thermal impacts from wetlands are reduced when compared to ponds due to increased surface area coverage by wetlands vegetation. Hamilton City Council is recommending 80% vegetation cover in wetlands to help mitigate potential thermal effects.

A treatment train approach with multiple devices in series can mitigate the effects of impervious surface temperature increases by moderating temperature as the water passes through multiple devices. In addition, establishment or maintenance of riparian buffers, including large shade trees, would also reduce stream thermal effects.

6.2.2.8 Cost

Stormwater management costs can relate to several factors including:

- Property acquisition
- Device construction, and
- Whole of life costs relating to subsequent operational expenses.

All of these factors can, and should, enter into decisions regarding device selection and implementation. Costs may be difficult to predict on a nationwide basis depending on regulatory requirements from various consenting authorities, and site acquisition costs will be highly variable.

⁶⁵ Black, 1980

⁶⁶ Richardson et al, 1994

⁶⁷ Quinn et al, 1994

⁶⁸ Simons, 1986

⁶⁹ Maxted et al, 2005

An example of highway expected costs comes from the State of Washington⁷⁰ where the Washington State Department of Transportation estimates \$7 million/year for maintenance of stormwater devices and capital costs ranging from 8 - 20 percent of total project costs depending on project type and location.

Experience by this author of stormwater management devices over the years has indicated operational costs would approximate 5% of construction costs on an annual basis to ensure adequate funding for maintenance activities. There will be years where that funding is not completely used but there will be other years where significant maintenance is required, which averages the long-term costs across the asset life.

One element of costs that may not normally be considered are the benefits of stormwater management relating to the following:

- Flooding and property damage
- Degradation of water quality effects in the receiving environment
- Loss of fish and wildlife habitat,
- Sedimentation in harbours and estuaries, and
- Loss of marine habitat

One study has utilised a non-market valuation technique to quantify some of the valued aspects of Auckland's marine environment.⁷¹ They considered that the total benefits derived, based on the level of water quality at that time, were estimated to be \$442 million (in 1991 dollars) per annum. In addition, scenarios were considered to calculate future benefits and losses as a result of deterioration in water quality. This work was only an estimation of values associated with the marine environment and excluded freshwater environmental values and the avoided property and safety implications of flooding events in developed areas. While this was only one study it is indicative that there are financial benefits to implementation of stormwater management.

Previous discussion has also recognised that using an LID approach to site development can provide cost savings over traditional development.

6.2.3 Contaminant generation

Addressing contaminants should be undertaken on the basis of the receiving system and the potential contaminants generated by the land use activity in the catchment.

For years, most stormwater management programmes have been focused towards removal of suspended solids, however that may not be appropriate for activity-derived contaminants or for some of the receiving environments in the Waikato Region. For example, for Lake Rotokauri to the west of Hamilton, phosphorus is the key contaminant of concern, with phosphorus removal being the controlling factor when considering what stormwater management devices are required to achieve water quality targets.

When looking at contaminant generation potential, New Zealand data is similar to water quality data collected overseas. Section 12 has a detailed discussion on calculation of contaminant loads for various land uses.

In terms of device selection, New Zealand data indicates that as with overseas studies, lead is the least soluble of the key elements in stormwater (<10%) with zinc being the most soluble (about 40%). Cadmium and copper appear to be moderately soluble with about 30% in the soluble phase. If zinc is a concern on a given project, devices that rely on sedimentation will not be effective at total zinc removal. If lead were a specific concern, sedimentation would be an effective approach.

⁷⁰ Hoey et al, 2000

⁷¹ Ward et al, 1991

The Auckland Council has developed a contaminant load model⁷² that inputs the land use type) that is generating the contaminant and then allows various stormwater management devices to be applied to determine contaminant discharge from a given area.

For roads, the contaminant model considers various vehicles/day and applies contaminant loads for that situation as shown in the Table 6-8 below.

Table 6-8: Contaminant loads for various daily traffic counts

Vehicles/day	Contaminant unit loadings for various contaminants			
	Sediment (g/m ² /yr)	Zinc (g/m ² /yr)	Copper (g/m ² /yr)	Total Petroleum Hydrocarbons (g/m ² /yr)
<1,000	4	0.021	0.0070	0.11
1,000-5,000	30	0.107	0.0349	0.54
5,000-20,000	150	0.537	0.1744	2.68
20,000-50,000	299	1.068	0.3472	5.34
50,000-100,000	300	2.281	0.7414	11.41
>100,000	300	3.532	1.1480	17.66

Very high traffic roadways can have a significant impact on contaminant delivery to a receiving system. The daily traffic count can be used to help determine stormwater management requirement for trafficked areas, including identification of contaminant hot spots.

More detailed discussion of contaminant load determination approach is provided in Section 12.

Depending on what roofing material has been used, roofs can generate contaminants. The most common metals in roof runoff are lead, copper and zinc. Increased zinc concentrations correlate to rainfall passing directly over metal roofs (galvanised metal, zincalume roofs). The zinc concentration from galvanised roofs is related to the degree of weathering and corrosion with heavily weathered and corroded roofs having five times the zinc concentration compared to roofs in good condition. Much of the zinc is in the dissolved state.⁷³

Table 6-9 below provides a summary of contaminant discharges from roofing materials.

Table 6-9: Contaminant discharges from roofing materials⁷³

Roof type	Location	Concentration (mg/m ³)			
		Cadmium	Copper	Lead	Zinc
Concrete type/asbestos cement	International,	0.14	11	46	100
	New Zealand*	<0.05, <0.05	0.5, 3.3	0.2, 2.1	20, 17
Tile/paint	International,	0.40	304	41	49
	New Zealand	<0.05	1.7	1.4	281
Zinc/galvanised metal	International	1.2	20	58	3,500
Colour Steel	New Zealand	-	<0.5	<0.1	29
Painted galvanised metal	International	-	-	-	1,300
Painted galvanised metal	New Zealand	<0.05	< 0.05	14	1,000
Unpainted galvanised iron	New Zealand	<0.05	<0.05	3.2	2,500
Zincalume	New Zealand	<0.05	0.8	0.6	432

⁷² Auckland Regional Council version, May 2006

⁷³ Kingett Mitchell, Diffuse Sources, 2003

Roof type	Location	Concentration (mg/m ³)			
		Cadmium	Copper	Lead	Zinc
Other metal	International	-	890	13	1,980
Gravel	International	0.11	7	2.0	62
Polyester	International	0.24	534	20	79
Miscellaneous other	International	0.65	16	24	495

Note: * Artificial tile roofs, concrete tile house roofs

As can be seen from the table above, concrete tiles, colour steel and gravel have low contaminant discharge potential and hence it is considered that runoff from these surfaces does not require water quality treatment. All other roof types, other than green roofs, should consider water quality treatment for roof runoff.

In addition to the roofing material type, from an overall runoff potential, contaminant discharge from industrial activities will also need to include consideration of dry deposition of road dust and/or factory exhausts on roofs. High zinc concentrations in the runoff in industrial areas is likely to be due to dry deposition on roofs of road dust and/or factory exhausts (smoke stacks, extractor fans, etc.). High zinc and relatively high lead concentrations, together with detectable chromium and nickel shows that roofs in industrial sites have the potential for contributing very high concentrations of contaminants to stormwater runoff. Thus, effectively addressing stormwater runoff at industrial sites will require consideration of roof runoff water quality as well as yard practices and associated runoff water quality.⁷³ Large industrial roofs often provide habitat for large flocking birds (such as gulls) which can contribute significant faecal contaminant to stormwater runoff.

Contaminant discharge potential will generally be activity and location specific and requirements to treat industrial roof runoff will be industry specific. Any stormwater diversion and discharge consent application for an industrial activity must provide information related to potential deposition of contaminants from dry deposition on roof areas. Based on this information, council will determine the need for water quality treatment of roof runoff.

6.2.4 Contaminant removal processes

Once the contaminants of greatest concern are identified, it is important to understand the processes that may be used to reduce contaminant discharge downstream. The following table lists all of the principal mechanisms that can capture, hold and transform various classes of contaminants in stormwater runoff and the factors that promote the operation of each mechanism to improve water quality.

Table 6-10: Summary of contaminant removal mechanisms

Mechanism	Contaminants affected	Removal promoted by
Physical sedimentation	Solids, BOD, pathogens, particulate COD, P, N, metals, synthetic organics	Low turbulence
Filtration	Same as sedimentation	Fine, dense herbaceous plants, constructed filters
Soil incorporation	All	Medium-fine texture
Chemical precipitation	Dissolved P, metals	High alkalinity
Adsorption	Dissolved P, metals, synthetic organics	High soil Al, Fe, high soil organics, neutral pH
Ion exchange	Dissolved metals	High soil cation exchange capacity
Oxidation	COD, petroleum hydrocarbons, synthetic organics	Aerobic conditions
Photolysis	Same as oxidation	High light
Volatilisation	Volatile petroleum hydrocarbons and synthetic organics	High temperature and air movement
Biological microbial decomposition	BOD, COD, petroleum hydrocarbons, synthetic organics	High plant surface area and soil organics
Plant uptake and metabolism	P, N, metals	High plant activity and surface area
Natural die-off	Pathogens	Plant excretions
Nitrification	NH ₃ -N	Dissolved oxygen>2mg/l, low toxicants, temperature>5-7°C, neutral pH
Denitrification	NO ₃ +NO ₂ -N	Anaerobic, low toxicants, temperature>15°C

A key factor to consider in the functioning of all mechanisms is time. The effectiveness of settling a solid particle is directly related to the time provided to complete sedimentation at the particle's characteristic settling velocity (refer to Table 5-4 for settling velocities).

Time is also a crucial variable to determine the degree that chemical and biological mechanisms operate. Characteristic rates of chemical reactions and biologically mediated processes must be incorporated to obtain treatment benefits. For all of these reasons, water residence time is the most basic variable to apply as an effective treatment device technology.

The information provided in Table 6-10 can also be arranged by features that promote specific contaminant removal objectives. The following features provide for most objectives:

- Features that assist in achieving any objective:
 - Increasing hydraulic residence time
 - Low turbulence
 - Fine, dense herbaceous plants, and
 - Medium-fine textured soil.
- Features that assist in achieving specific objectives:
 - Phosphorus control
 - High soil exchangeable aluminium and/or iron content

- Addition of precipitating agents
- Nitrogen control
 - Alternating aerobic and anaerobic conditions
 - Low toxicants
 - Neutral pH
- Metals control
 - High soil organic content
 - High soil cation exchange capacity
 - Neutral pH
- Organic control
 - Aerobic conditions
 - High light
 - High soil organic content
 - Low toxicants
 - Neutral pH.

6.2.5 Device selection

Whilst Section 8 provides detailed discussion on choosing and designing stormwater management devices, this sub-section provides a more generic discussion of devices and their ability to remove various contaminants and function for water quantity control.

In a number of situations, stormwater management devices can provide both water quantity and water quality control for a given site. In other situations, this may not be possible and multiple devices may be required to achieve desired outcomes.

Table 6-11 below provides some discussion of various devices and their ability to address water quantity and water quality for various contaminants.

Table 6-11: Stormwater management device capabilities

Device	Peak flow control	Water quality treatment			
		Sediment	Metals	TPH	Nutrients
Dry pond with extended detention	High	Moderate	Pb - Moderate Cu - Low Zn - Low	Low	P - Low N - Low
Wet pond with extended detention	High	High	Pb - High Cu - Moderate Zn - Moderate	Low	P - Moderate N - Low
Wetland	High	High	Pb - High Cu - High Zn - High	High	P - High N - High
Filter systems	Low	High	Pb - High Cu - Moderate Zn - Low	High	P - Moderate N - Low
Rain gardens	Low	High	Pb - High Cu - High Zn - High	High	P - High N - Moderate
Infiltration	Moderate	High	Pb - High Cu - High Zn - High	High	P - High N - Moderate

Device	Peak flow control	Water quality treatment			
		Sediment	Metals	TPH	Nutrients
Swales and filter strips	Low	High	Pb - High Cu - Moderate Zn - Moderate	Moderate	P - Moderate N - Low

The ability of different devices to mitigate thermal effects is not outlined in the above table. Of the devices that are listed in this table, wet ponds can lead to thermal effects and hence are to be used with caution.

As can be seen from this table, selection of a stormwater management device or devices will depend on the contaminants of concern and whether peak flow control is a requirement. Other than ponds and wetlands, water quality devices have limited peak flow control capability and must be used in conjunction with another device if overall peak flow control is to be achieved for the project.

6.2.6 Treatment train approach

As mentioned briefly in the previous paragraph, water quality treatment devices generally have limited peak flow control capability and must be used in conjunction with a water quantity control device if both issues (water quantity/water quality) are to be addressed.

It is difficult for one device to provide for multiple benefits. Increasingly more emphasis is being placed on a stormwater “treatment train” approach to stormwater management, where several different types of stormwater devices are used together and integrated into a comprehensive stormwater management system for the site.

A treatment train approach ideally considers various levels of stormwater management that includes both source control (with an LID basis) and treatment as part of the overall approach. Source control is generally not considered and can have significant value.

Once source control has been implemented to the maximum degree that it can, contaminant removal and peak flow control would then be pursued.

Minton⁷⁴ provides a number of recommendations for a treatment train approach that have been adapted in the following table to discuss how various devices may work in conjunction with one another.

Table 6-12: Treatment train examples

Function	Examples
Removal of coarse solids to reduce maintenance costs	Forebay in a wet pond or extended detention dry pond followed by a sand filter
Removal of fine sediments to meet a treatment performance goal	Sand filter followed by a wet pond or wetland
Removal of dissolved contaminants	Sorptive media filter followed by wet pond, wetland or rain garden
Reduction of petroleum hydrocarbons to prevent clogging of a second treatment practice	API unit followed by a sand filter or rain garden
Removal of nutrients	Conventional stormwater management device for removal of sediments/metals followed by a nutrient removal device (wetlands, rain garden designed in accordance with Figure 8-14)
Removal of litter to prevent clogging or fouling a second treatment practice	Continuous deflection separation followed by a wetland
Infiltration	Swale followed by an Infiltration practice
Aesthetics	Rain garden followed by a wetland

⁷⁴ Minton, 2006

Function	Examples
Wildlife habitat	Rain gardens followed by a wetland
Reliability of long term performance	Wet pond followed by a wetland

Recommendations also adapted from this overall list include the following:

- Follow the golden rule: Don't place two devices in a treatment train that have the same function.
- Conversely, follow the second golden rule: have a different function for each element of the treatment train.
- When considering a specific system component, the specific contaminant to be removed should be identified, rather than thinking in terms of a general removal of multiple contaminants.
- Any two elements of the system should be considered separately.
- Recognise that including a second element may only provide minor benefit hence the additional expected benefit of an additional element should be compared to the incremental cost of the added element operation.
- Care should be taken when calculating efficiency of the overall treatment train.

An example of a treatment train approach could be the use of swales adjacent to a roadway. The swales would then discharge into a wetland. The combination of devices would provide water quantity control and water quality control for sediments and dissolved metals. Depending on the outlet design of the wetland, hydrocarbons would be volatilised and evaporate. The combination of devices would provide excellent water quality control.

Where nutrients are a concern in addition to sediments and metals, examples would include practices that either promote vegetation growth and subsequent harvesting, or promote denitrification through an anaerobic zone that allows conversion of nitrates to nitrites to free nitrogen gas. In these situations, initial devices would remove sediments and metals and be followed by the device or devices designed to remove nutrients. Table 6-12 lists the processes that are necessary to remove contaminants, including nutrients.

6.2.6.1 Benefits of devices in series

While these devices provide individual benefits for removal of contaminants, their use in series can provide greater benefit than those used only individually.

A simplified equation for the total removal of a given contaminant for two or more stormwater management devices in series is the following⁷⁵:

$$R = A + B - [(A \times B) / 100]$$

Where:

R = total removal rate

A = Removal rate of the first or upstream practice

B = Removal rate of the second or downstream practice

The use of this equation is easiest when considering removal percentages rather than using effluent limits as data on performance of devices for effluent limits can be highly variable.

Refer to Table 6-13 below for indicative removal rates for different stormwater management devices for a range of contaminants. Using the removal rates provided in this table will allow for calculation of overall removal of the contaminant/s of concern.

As an example, a stormwater management approach uses a swale to drain into a wetland to provide for water quality treatment for both sediment and nutrients from a road project.

⁷⁵ State of New Jersey Department of Environmental Protection, 2004

$$R = A + B - [(A \times B) / 100]$$

$$\text{For sediment } R = 70 + 90 - [(70 \times 90) / 100] = 160 - 63 = 97\% \text{ removal}$$

$$\text{For nitrogen } R = 20 + 40 - [20 \times 40 / 100] = 60 - 8 = 52\% \text{ removal}$$

$$\text{For phosphorus } R = 30 + 50 - [(30 \times 50) / 100] = 80 - 15 = 65\% \text{ removal}$$

Obviously, the results depend on the removal rates of a given contaminant by a specific device. The values given in Table 6-13 are relative values based on international literature. There will be local variation and hence the values are considered indicative.

When using stormwater treatment devices in series, arrange the devices from upstream to downstream in ascending order of the contaminant removal ability. The device achieving the lowest contaminant removal should be placed upstream of the device achieving the higher level of contaminant removal.

Table 6-13: Removal rates for various stormwater devices

Practice	Removal rates (%)					
	TSS	Nitrogen	Phosphorus	Zinc	Copper	TPH
Swales	75	20	30	50	60	40
Filter strips	70	20	20	50	60	30
Sand filters	80	35	45	90	90	70
Bioretention devices (normal)	80	40	60	70	75	70
Bioretention devices (w/anaerobic zone)	80	50	80	70	75	70
Infiltration devices	80	30	60	80	70	50
Dry ponds (no extended detention)	As dry ponds primary purpose is peak flow control, they are not assigned water quality removal rates. They are not recommended for use as a primary treatment practice.					
Dry ponds (with extended detention)	60	20	30	20	30	10
Wet ponds (with extended detention)	75	25	40	30	40	20
Wetlands	80	40	50	60	70	60
Green roofs	Volume reduction and some water quality treatment ¹					NA
Rainwater reuse tanks	Volume reduction and some water quality treatment ¹					NA
Detention tanks	Peak flow control only					
Oil water separators	15	0	5	5	5	Depends on manufacturer

NOTE:

¹ Green roofs and rainwater reuse tanks address water quality primarily by preventing runoff from being generated by the rooftop. They can prevent stormwater from discharging from the rooftop, potentially eliminating the need for ground level treatment of roof runoff depending on the contaminants of concern.

7 Design criteria

When considering hydrologic design criteria recommendations, the recommendations have to be considered in light of the issues discussed in Section 5 regarding the receiving environment. These issues include:

- Water quantity
- Stream channel erosion, and
- Water quality.

The following sections discuss the three issues regarding hydrologic recommendations.

7.1 Water quantity design

There are two purposes for implementation of water quantity control:

- Preventing existing downstream flooding problems from getting worse, and
- Controlling intermediate storms to minimise potential increases in out-of-bank flows downstream.

Both of these situations may be encountered on a case-by-case basis. It is important to define the source of flooding problems and situations where flooding issues need to be addressed.

The situation considered in this guideline is flooding that is being caused or exacerbated by new impervious surfaces. These surfaces increase stormwater runoff from a pre-development condition that may have been pasture or bush. It is not the intent of this guideline to consider flooding from a tidal surge context. Thus, flooding issues are considered on streams or reticulation systems located within catchments that drain rainfall-generated runoff and are not tidally induced.

7.1.1 Preventing existing flooding problems from getting worse

It is imperative that development projects do not increase the risk of downstream flooding where there is flooding potential for existing structures. Structures, in this context, could be habitable buildings or highways.

Where there are downstream flooding problems, peak discharges for the post-development 100-year ARI event may need to be managed to ensure that downstream flood levels are not increased. This will depend on whether the timing of stormwater discharges is an issue, which depends on the catchment, the number of tributaries and the location of the project in a catchment.

Two bodies of work have been undertaken related to preventing increases in downstream flood potential when hydrologic analyses have not been carried out on a catchment-wide basis.

In a study of the Flat Bush catchment in Manukau City⁷⁶ catchment modelling was undertaken to determine what level of attenuation was required to mitigate potential downstream flood effects. It was determined that appropriate criteria was that the post-development peak flows for the 100-year ARI event were attenuated to 80% of the pre-development peak flows for the same design event. This level of over-attenuation was found to be warranted to compensate for the increased volume of runoff resulting from development in the catchment. Normal attenuation of this runoff in ponds considerably extends the duration of sub-catchment peak flows, potentially resulting in a greater coincidence of peaks and therefore a greater combined downstream discharge than occurs in the pre-development situation. The indicative target of 80% is necessary to avoid any cumulative hydrological effects that could increase the peak flow downstream.

⁷⁶ Manukau City Council, 2004

A study was undertaken of a catchment in New Jersey in the United States⁷⁷ where development is proposed at a site referred to as Location 1. The same criteria as above has been applied in this jurisdiction (post-development flows attenuated to 80% of the pre-development 100-year ARI peak flows) to mitigate downstream flood effects.

Figure 7-1 shows the comparison of peak flows for the pre-developed and post-developed scenario throughout the catchment relative to the site (Location 1). The vertical axis shows the ratio of post-development peak discharge and pre-developed peak discharge where the value of 1 is where the two discharges are the same. Using the 80% peak flow criteria shows that the ratio is always less than 1 as you travel through the catchment.

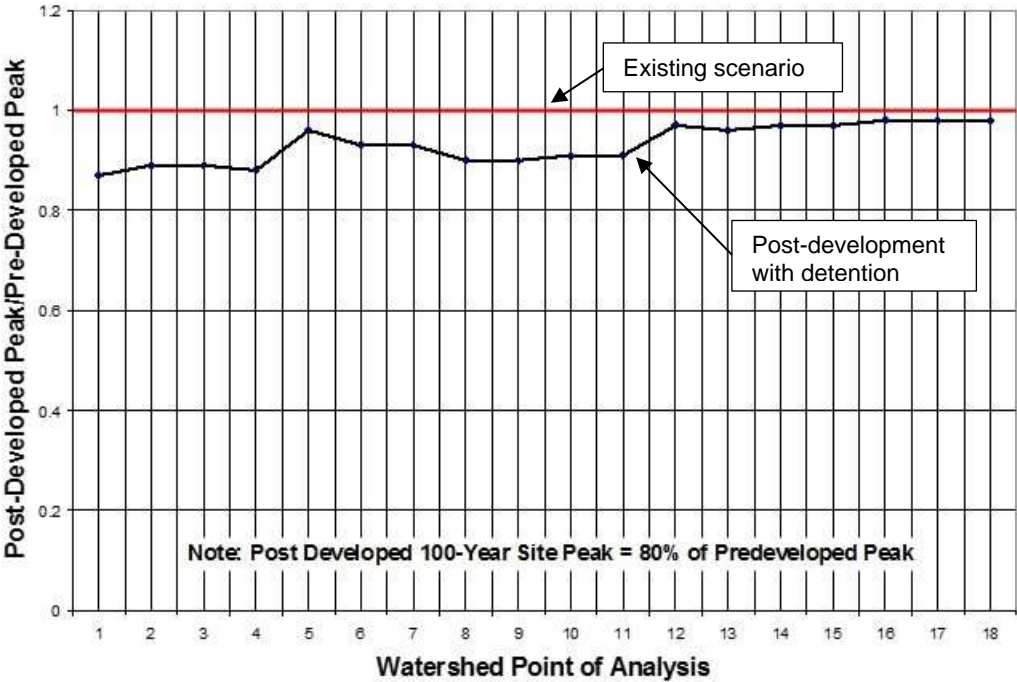

Figure 7-1: Pre and post-development 100-year ARI peak flow rates in a catchment

An examination of the comparison shows that, under this level of peak rate control, post-developed runoff rates are less than pre-developed for the entire storm. This increased time period offers greater opportunity for this and other post-developed site hydrographs with similar levels of control to combine downstream in such a way as to produce a total downstream peak that is no greater than the pre-developed peak at that location.

Where there are existing downstream flooding problems (to habitable structures or roads) ideally a catchment-wide analysis would be undertaken to determine potential adverse effects of upstream development. This would allow assessment of specific design requirements to be determined that would ensure downstream flood effects were not exacerbated.

In the absence of a catchment study that evaluates a potential project in a given location, it is important to err on the side of caution, especially where human safety or structure damage is concerned. As such, in catchments where flooding problems do exist and there is no catchment management plan or catchment wide analysis, it is required that the post-development peak discharge for the 100-year ARI event for a new development be limited to 80% of the pre-development peak discharge.

7.1.2 Controlling intermediate storms

The intent of peak discharge control of intermediate storms is to limit downstream increases in rainfall events from the 2-year ARI event and larger. The issue of which storms to control has been considered⁷⁸ through an analysis of a number of different policies for peak flow control.

⁷⁷ Shaver et al, 2007

⁷⁸ Maryland Department of Natural Resources, 1982

By considering a wide range of policies in conjunction with their peak flows, volumes and timing the effects of the various policies can be visually represented through flow duration curves and hydrographs. Figure 7-2 below shows a comparison of flood frequency curves for various stormwater management policies.

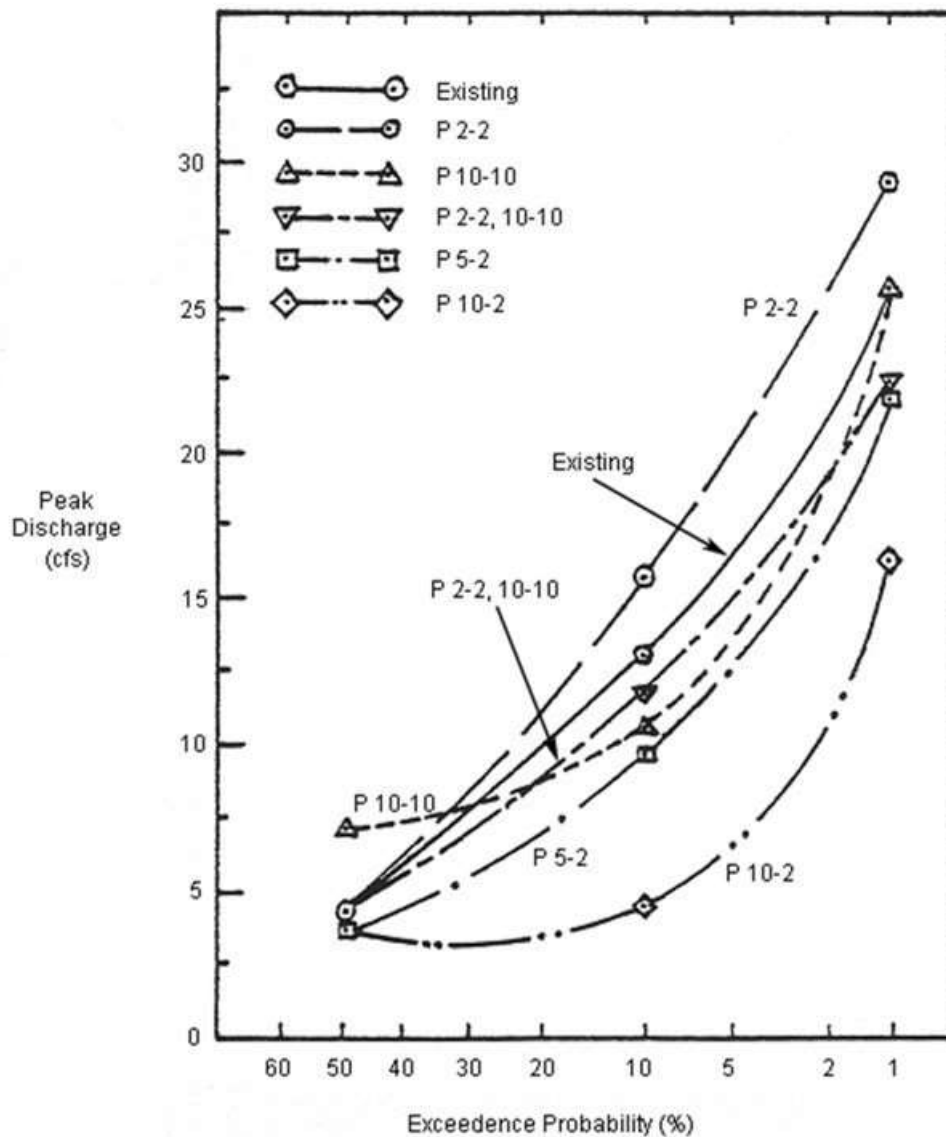

Figure 7-2: Comparison of flood frequency curves for various stormwater policies⁷⁸

To explain what the numbers mean, P stands for policy while the first number after the P stands for the post-development storm frequency and the second number stands for the pre-development storm frequency. A P 2-2 reflects a policy where the post-development peak discharge for the 2-year ARI event cannot exceed the pre-development peak discharge for the 2-year ARI event. A P 5-2 policy means that the post-development 5-year ARI peak discharges cannot exceed the 2-year ARI pre-development peak discharge.

What can be seen from the figure is that the 2-2, 10-10 (post-development 2-year ARI event cannot exceed the pre-development 2-year ARI event and the 10-year ARI post-development event cannot exceed the pre-development 10-year ARI event) comes closest to matching the existing frequency curve. By providing multiple storm controls, the post-development frequency curve comes closest to the pre-development frequency curve. Matching the 2 and 10-year ARI post-development events to their pre-development level is a common way of minimising downstream intermediate storm peak discharge increases.

7.1.3 Catchment location

A major consideration regarding the requirement for peak flow control is catchment location. As a general rule, stormwater detention for peak flow control should only be provided for developments located in the top half of a catchment to ensure that the potential for discharge peaks to coincide does not occur. This is to ensure the discharge peak from the development does not coincide with the discharge peak from the upper catchment.

It is noted that this is a simplified approach, as there are other variables that can affect the timing of discharge peaks, including catchment shape, topography, surface type, etc. It is expected that stormwater design will be undertaken by experienced stormwater practitioners who will be able to determine whether peak flow control is required.

The optimal approach to determine where peak flow control is required in a catchment is to conduct a comprehensive catchment analysis where potential locations for peak flow control can be considered. In these situations the study results will determine the need for peak flow control at potential locations within the catchment.

If there is confusion regarding whether peak flow control is required, Waikato Regional Council staff can be contacted to discuss further.

The same concern does not apply to erosion control criteria, where imposition of volume or extended detention control are required throughout the catchment.

7.1.4 Design rainfall

Waikato Regional Council accepts design rainfall derived using NIWA's High Intensity Rainfall Design System (HIRDS) Version 3⁷⁹ or more recent versions as they become available.

7.1.5 Hydrologic design method

Hydrologic analyses for all stormwater management purposes should be undertaken according to the Waikato Stormwater Runoff Modelling Guideline⁸⁰.

Waikato Regional Council may consider it acceptable for a consultant or other entity to use an alternative method or computer model as long as it is a legitimate and well recognised method/model.

If required, the consultant/entity must be able to demonstrate that the proposed alternative approach is robust and provides comparable outputs to what would be determined using the method outlined in the Waikato Stormwater Runoff Modelling Guideline.

7.1.5.1 Modelling

When modelling for water quality treatment, extended detention, 2 and 10-year ARI event peak flow control, consider the catchment (or site) to be heterogeneous. Heterogeneous catchments should be modelled by division into separate homogeneous sub-catchments, connected by hydraulic elements.

For water quality and extended detention events, issues such as timing or response time are not important as for larger storms. Vegetated swales and filter strips are designed for a peak flow rate, but as they serve very small catchments the catchment response time can be ignored and the peak 10-minute rainfall rate used (minus losses).

For 2 and 10-year ARI peak flow determination timing is important. The procedure outlined in the Waikato Stormwater Runoff Modelling Guideline should be used to complete the analysis.

Water quality volume is the 'total outflow' obtained by summing the storm runoff volumes from separate analyses of the pervious and impervious catchment areas.

As an additional guidance note relevant to designing swales, wetland swales and filter strips, it is necessary to assess the peak velocities for the water quality event, to ensure the devices are

⁷⁹ <https://hirds.niwa.co.nz/>

⁸⁰ Waikato Regional Council, 2018

adequately sized. To enable the impact of retention to be incorporated into this assessment, it is recommended that the designer assumes the impervious surfaces have an initial abstraction that is equal to the pre-development initial abstraction, and calculate the peak flow rate, and then velocity, on this basis.

7.1.5.2 Alternative design methods

Waikato Regional Council recommends that designers use the Waikato Hydrological Modelling Guideline for design calculations. The use of this method will ensure that comparable results are obtained by the use of standard input parameters. It also ensures consistency in analyses within a catchment.

The primary situation where alternative methods of design may be used (with Waikato Regional Council approval) is when catchment-wide analyses are undertaken. This may be the situation where characteristics of the catchment or management approach may be better considered through a model that is more appropriate for the specific catchment.

Communication between the individual proposing an alternative method of design and Waikato Regional Council should be undertaken prior to modelling being initiated to ensure there are no disagreements on the method of analysis.

7.1.6 Effects of climate change

The climate is changing. While climate change is a natural process, increased greenhouse gas concentrations are projected to exacerbate the drivers of our climate in ways that may be irreversible. Even if significant global action is taken now to reduce greenhouse gas concentrations, a degree of climate change is inevitable in our lifetime.

The Resource Management (Energy and Climate Change) Amendment Act 2004 requires councils to have particular regard to the effects of climate change.

WRC's Regional Policy Statement provides a basis for planning for and undertaking climate change adaptation actions. The Regional Policy Statement acknowledges the need to manage natural hazards such as flooding landslides and large-scale rock/soil mass movements, severe weather events, drought and fire. Climate change will increase the risk from these hazards and make their management even more important. The key policies within the Regional Policy Statement relevant to climate change adaptation are contained below:

The effects of climate change (including climate variability) may impact our ability to provide for our wellbeing, including health and safety. While addressing this issue generally, specific focus should be directed to the following matters:

- a) Increased potential for storm damage and weather-related natural hazards; and*
- b) Long term risks of sea level rise to settlements and infrastructure such as through increased coastal flooding and erosion.*

3.6 Adapting to climate change land use is managed to avoid the potential adverse effects of climate change induced weather variability and sea level rise on:

- a) Amenity;*
- b) The built environment, including infrastructure;*
- c) Indigenous biodiversity;*
- d) Natural character;*
- e) Public health and safety; and*
- f) Public access.*

4.1.13 Incorporating effects of climate change

Local authorities should, and regional and district plans shall, recognise and provide for the projected effects of climate change, having particular regard to:

- a) Historic long-term local climate data;*

- b) *Projected increase in rainfall intensity, taking account of the most recent national guidance and assuming a minimum increase in temperature of 2.1°C by 2090 (relative to 1990 levels); and*
- c) *Projected increase in sea level, taking into account the most recent national guidance and assuming a minimum increase in sea level of 0.8m by 2090 (relative to 1990 levels).*

Note that 4.1.13 b) and c) are minimum values and the most current guidance on projected temperature and sea level rise shall be used.

The nature of climate change data is that it is being regularly updated and hence climate change guidance is being regularly updated. For the purposes of stormwater design, practitioners are directed to use the most up to date Ministry for the Environment (MfE) climate change guidance, which can be found at the following website:

<http://www.mfe.govt.nz/climate-change/climate-change-resources/guidance-local-government>

The following lists the MfE guidance that can be found:

- Climate change effects and impacts assessment
- Climate change effects and impacts assessment: A guidance manual for local government in New Zealand
- Climate change projections for New Zealand snapshot
- Climate Change projections for New Zealand

Coastal hazards and climate change

- Coastal hazards and climate change: A guidance manual for local government in New Zealand
- Preparing for coastal change: A guide for local government in New Zealand (summary publication)

Tools for estimating the effects of climate change on flood flow

- Tools for estimating the effects of climate change on flood flow: A guidance manual for local government in New Zealand
- Preparing for future flooding: A guide for local government in New Zealand (summary publication)

Waikato Regional Council has prepared a Climate Change Guideline⁸¹ to assist internal regional council staff in planning for climate change in relation to the many and varied operational activities delivered by the regional council. The regional council is currently updating this guideline and the scope of this update includes widening the scope of the guideline to cater for a wider audience, including those external to the regional council. Once updated this guideline will be available from the regional council's website.

Incorporating climate change predictions into stormwater design is important if infrastructure is to maintain the same level of service throughout its lifetime, and to ensure that development occurs in areas that will not be subject to future flood risk. Climate change is occurring now but predicted temperature increases are what is expected to occur some time in the future. As a result for stormwater design, **pre-development rainfall data should not be adjusted for climate change while post-development rainfall data should be adjusted for climate change.** In the current version of HIRDS Version 4, the 'historic' data represents the existing/pre-development rainfall data.

⁸¹ <https://www.waikatoregion.govt.nz/assets/WRC/Services/publications/other-publications/Climate-Change-Guideline-ICM-FINAL-Sept-2017.pdf>

7.1.7 Peak flow control criteria

There are five requirements related to peak flow control criteria:

1. Rainfall data used for all rainfall events shall have 24-hour rainfall distribution.
2. The rainfall data for the 2, 10 and 100-year ARI events should be increased for the post-development scenario to allow for predicted climate change in accordance with Section 7.1.6.
3. Where there are existing downstream flooding issues, depending on the site's position in the catchment (refer to Section 7.1.3), it is recommended that the post-development peak discharge for the 100-year ARI rainfall event for a new development be limited to 80% of the pre-development peak discharge (unless there is a catchment study that demonstrates that this is not required).
4. In terms of intermediate storm control, depending on the site's position in the catchment (refer to Section 7.1.3), the 2 and 10-year ARI post-development peak discharges shall not exceed the 2 and 10-year ARI pre-development peak discharges.
5. As discussed in Section 7.1.3, peak flow control is generally only recommended for projects located in the top half of catchments so as to avoid concerns over coincidence of peaks aggravating downstream flooding concerns. It is expected that stormwater design will be undertaken by experienced stormwater practitioners who will be able to determine whether peak flow control is required. If there is confusion regarding whether peak flow control is required, Waikato Regional Council staff can be contacted to discuss further.

7.2 Stream channel erosion

Urban development has the effect of increasing the frequency and magnitude of stormwater flows, particularly during frequent, small rainfall events. As a consequence, streams suffer channel stability problems.

The composition of the stream banks and bed are the key factors in stream erodibility. Erosion occurs when the shear stress (the "force" of water flowing along the bed and banks) exceeds the ability of the banks or bed to withstand it. Stream erosion is sensitive to changes in the magnitude of flood flows⁸².

A more accurate approach to stream erosion is based on consideration of shear stress. In principle, the total shear stress on the bed of a stream is the average stress over the bed of a stream ($\tau - \text{N/m}^2$) that resists the gravitational forces on the water under uniform conditions⁸³. In practice, shear stress is difficult to calculate because the water surface slope or energy slope varies across and along the reach of a river.

That being the case, permissible velocities are established to control stream erosion. Table 7-1 provides information on permissible velocities that limit stream channel erosion concerns.

⁸² Beca, 2001

⁸³ Jowett et al, 2006

Table 7-1: Maximum permissible velocities⁸⁴

Material	Velocity (m/s)
Fine sand (colloidal)	0.46
Sandy loam (noncolloidal)	0.53
Silt loam (noncolloidal)	0.61
Alluvial silt (noncolloidal)	0.61
Ordinary firm loam	0.76
Volcanic ash	0.76
Fine gravel	0.76
Stiff clay	1.14
Graded loam to cobbles (noncolloidal)	1.14
Alluvial silt (colloidal)	1.14
Graded silt to cobbles (colloidal)	1.22
Coarse gravel (noncolloidal)	1.22
Cobbles and shingles	1.52
Shales and hard pans	1.83

A compounding factor relating to stream erosion depends on whether the stream has a floodplain or is an incised gully with channel flow whose depth depends on the amount of water being transported.

In situations where there is a floodplain, the erosion potential does not increase significantly once the flow spreads out over the floodplain. As flows increase, the flow spreads out on the floodplain and the depth of flow and velocity do not significantly increase. Flow in incised channels progressively increases in velocity and depth as flow increases and leads to further increases in erosion potential.

When addressing stream erosion concerns, there are two methods for meeting erosion control objectives, these are discussed further below:

- Runoff volume control
- Detention time control

7.2.1 Runoff volume control

The volume of runoff can be used as a criterion for developing an erosion control recommendation. It is necessary to specify both the volume (or depth) of runoff to be stored and the duration over which this volume may generally be infiltrated into the ground or used for water supply purposes on site. A given volume of runoff might be specified for retention and that runoff must pass through the retention system and infiltrate in a given period of time, which would depend on the inter-event time period during that time of year when the average inter-event dry period is least.

An example of this is that storms in the region during winter months occur approximately every 2-3 days (2 days for Coromandel and Pukekohe, 3 days for the rest of the region). August is the month that has the shortest inter-event dry period. With this scenario, the retained volume must be drained within 48 hours to ensure that the storage volume is available for the next storm. Figure 7-3 shows the average days between rain events per month.

⁸⁴ Fortier et al, 1926

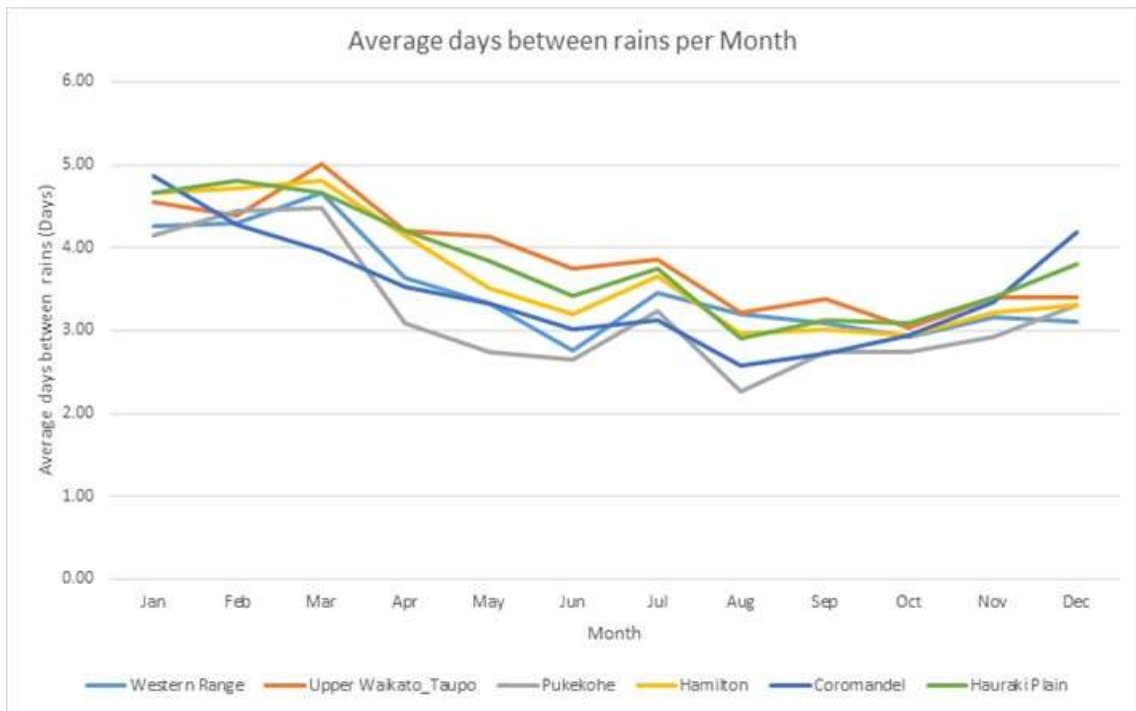

Figure 7-3: Average days between rains per month⁸⁵

It is also important to consider LID as a design element to reduce increases in stormwater runoff volume. Reduction in site disturbance, soil compaction, and impervious surfaces all translates into a reduction in increases in stormwater runoff volume and peak rates of discharge. LID should be incorporated into all site development plans to reduce potential impacts on receiving systems.

In terms of volume control for downstream erosion prevention, it is recommended that the difference between pre- and post-development total volume for smaller storms up to the 2-year ARI event be retained (rainwater re-use, soakage or bioretention) where possible. There will be situations where this volume cannot be retained on site due to slope or soil conditions. A minimum retention of the site pre-development initial abstraction from all impervious areas should be provided. If soil conditioning is not provided for intended pervious areas that have been earth-worked then the initial abstraction of runoff from the entire site should be retained.

The reasoning for this volume control criteria is that impervious surfaces have an initial abstraction essentially of approximately 1 mm, which is significantly less than the pre-development condition. Retaining the initial abstraction from impervious surfaces more closely replicates the pre-development condition for initiation of runoff.

If a detention device is proposed in combination with up-stream retention for a site, the volume retained can be deducted from the water quality volume and hence the calculated extended detention volume provided in the proposed downstream detention device. This credit for upstream retention applies to the provision of retention devices in public spaces, not on-lot. This is because there is less certainty about the ongoing performance of on-lot devices into the future.

From a hydrological analysis perspective, if the volume of runoff associated with the initial abstraction is retained on site, the analysis can use the pre-development initial abstraction for the post-development impervious surface initial abstraction, which will provide some reduction in larger storm volumes and peak rates of discharge.

⁸⁵ Koh S., 2016

7.2.2 Detention time control

Another option to mitigate erosion and scour effects is to establish an extended detention time, which is the time interval between the times of the inflow and outflow hydrographs when a defined percent of the volume has been discharged. In this situation duration of flow is recommended that effectively separate the detained flow from the storm hydrograph. A general recommendation of 24 hours is recommended to achieve this separation.

Retention of runoff should be considered prior to consideration of extended detention.

7.2.3 General discussion

The intent of volume control and extended detention is to prevent initiation or aggravation of stream channel erosion. By reducing the total volume of water running off the land or extending the time that flows take to travel through the catchment, channel erosion potential is reduced. Figure 7-4 below provides a visual representation of that intent.

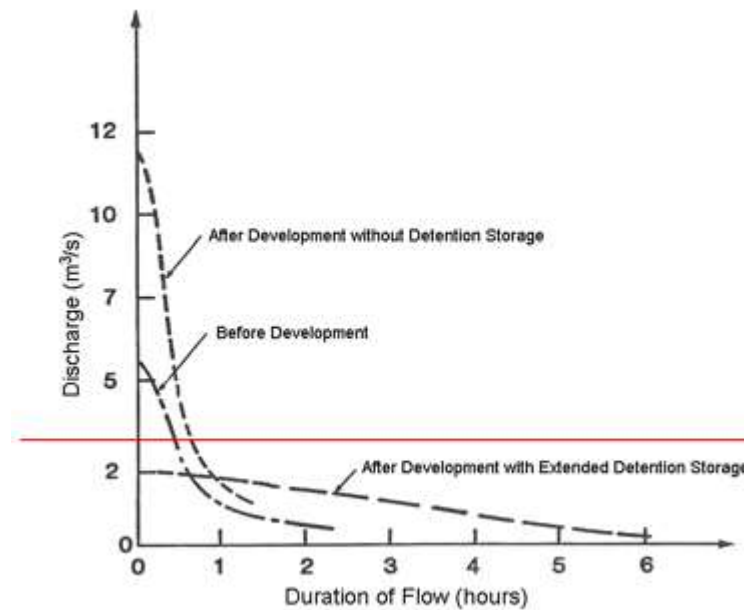

Figure 7-4: Discharge versus flow duration for pre and post development scenarios⁸⁶

In general, the figure relates flow discharge with flow duration. As discussed previously, peak rates of flow and higher velocities potentially cause channel erosion. Figure 7-4 shows three lines and those lines represent: pre-development flows without extended detention, post-development flows without extended detention, and the post-development condition with extended detention. If channel erosion were at a given flow rate (as an example $3 \text{ m}^3/\text{s}$) the red line would indicate where the flow becomes erosive. Both pre- and post-development conditions cause stream erosion while the extended detention discharge is below the erosion threshold.

It is recognised that erosion is a natural process, and the intent of volume control or an extended detention criteria is to prevent accelerated level of erosion as a result of increased catchment imperviousness.

There are two questions that need to be addressed:

- What criteria should be established?
- Where should the criteria be applied?

⁸⁶ McCuen, 1987

7.2.4 What criteria should be established?

An overseas study⁸⁶ for the case of non-cohesive sediments suggested that the runoff discharged from a detention basin for the post-development conditions and a 2-year 24-hour rainfall event should not exceed 25 mm over the 24 hour duration of the design storm. The discharge approximates that of a water quality event.

Work undertaken by Beca⁸⁷ indicated that for cohesive soils the discharge from a detention basin should not exceed 30 mm over the 24-hour duration storm or within a maximum peak outflow of 7.5 L/s/ha. The study also recommended having an active storage requirement of up to 130% of the water quality volume as being required to achieve erosion control in cohesive soils.

Another option to specific criteria would be for the project designer to calculate the receiving stream shear stress in the pre and post-development condition. If the stream is stable then maintain the pre-development peak flow rate and shear stress. If this analysis becomes too complicated then a generalised level of control is recommended.

For the purposes of this guideline, the initial abstraction of pre-development runoff losses from all site impervious areas should be retained on site in conjunction with either 1 or 1.2 times the water quality volume (the determination of which value to use depends on evidence of existing stream erosion).

The extended detention volume is that volume that is left after the initial abstraction retention volume is subtracted from it. The resulting volume should be live storage provided within the stormwater management device to be infiltrated or released over a 24-hour period.

7.2.5 Where the criteria should be applied

The criterion applies to natural (earthen) streams only. It does not have the same limitations or restrictions as peak flow control (top half of catchment), so will generally be recommended throughout a catchment. At the very bottom end of a catchment it is recommended that shear stress analyses be undertaken to determine whether volume control or extended detention is required.

In general in the Waikato Region natural stream channels are considered to be unstable unless the third bullet point applies.

There are a number of scenarios where extended detention need not be applied:

- Once tidal limits are reached, there is no need to consider extended detention.
- Discharges that are made directly to a major river, for example the Waikato, Waihou or Piako Rivers, with no direct discharge into tributary streams first.
- Where catchment slopes are very slight and velocities of flow are under those provided in Table 7-1. An example of this situation is around the Hauraki Plains. In this area, getting the water off the land is the problem and stream velocities for the 2-year ARI event may be below the permissible velocities.
- Catchment imperviousness is less than 3%, and
- There is no potential for future development to increase stream channel instability.

7.2.6 Water quality credit for extended detention

One benefit of providing extended detention for stream channel erosion control is that storing and releasing of stormwater over a 24-hour period will provide improved sedimentation due to gravitational sedimentation over that time. As a result, when used in conjunction with a wet pond or wetland the permanently stored volume calculated for water quality control can be

⁸⁷ Beca, 2001

reduced by 50% due to a water quality credit provided by the extended detention. This credit is provided if the criteria provided in Section 7.2.4 are followed.

7.2.7 Erosion control criteria

The following options address stream channel erosion.

There are four different approaches that address stream channel erosion:

1. It is recommended that the difference between the pre- and post-development total volume for smaller storms up to the 2-year ARI event be retained (rainwater re-use, soakage or bioretention) where possible.

There will be situations where this volume cannot be retained on site due to slope, water table or soil conditions. A minimum retention of the site pre-development initial abstraction from all impervious areas should be provided.

If soil conditioning is not provided for intended pervious areas that have been earth-worked then the initial abstraction of rainfall shall be retained using the following method.

The initial abstraction is rainfall and converting it to a volume of runoff for impervious surfaces is straightforward where the rainfall is assumed to be directly converted to runoff with no reduction in the amount.

For pervious areas that are not rehabilitated, additional analysis is necessary. In those situations:

- The pre-development runoff curve number (CN) is used to calculate the initial abstraction (I_{a1}) for the pervious areas.
- The post-development CN should be determined assuming that the soil group is altered to account for soil disruption and compaction where rehabilitation is not going to be done. Thus, a group A soil should be considered as a B soil in the post-development scenario (similar to a B becomes C, C becomes D). The initial abstraction (I_{a2}) is based on the altered soil grouping due to compaction.
- The required runoff retention due to soil compaction of the pervious areas is the following⁸⁸:

$$V_r = (I_{a1} - I_{a2}) \times A$$

Where:

V_r = Stormwater runoff volume for pervious areas that is to be retained (m^3)

I_{a1} = Initial abstraction for pervious area for pre-development soil condition (m)

I_{a2} = Initial abstraction for pervious area for post-development soil condition where soil rehabilitation has not been undertaken (m)

A = Surface area of compacted pervious surface (m^2)

- This volume is then combined with the impervious area retention volume to arrive at a total site retention volume.
2. Check the 2-year stream velocities against Table 7-1 to ensure that velocities are non-erosive. If they are non-erosive in the post-development condition assuming maximum probable development of the catchment, then no extended detention is required. If stream velocities are predicted to be erosive then criteria are provided in items 3 and 4 below.
 3. Implement extended detention or volume control according to the following:

⁸⁸ Refer to Section 5.1 of the Waikato Stormwater Runoff Modelling Guideline for more details

- a) If the stream is stable under the existing development condition, design detention or retention storage for a 24-hour release of an equivalent volume to the water quality storm.
 - b) If the stream is not stable (refer to Section 7.2.5 above for further discussion), multiply the water quality volume by 1.2 to determine the extended detention volume. That volume is then stored and released over a 24-hour period.
 - c) The relationship between initial abstraction (I_a) and the water quality volume and extended detention volume should be considered jointly. The water quality volume and the extended detention volume can be reduced by the retained initial abstraction volume (if retained within public spaces, not on-lot). If retention is provided for the full 2-year ARI event for a site, then no extended detention is required for smaller storms, and water quality would be considered to be addressed as well.
4. This item is for those situations where catchment development has already essentially been completed or for growth cell planning where a large proportion of the catchment is proposed to be developed and the effects of one more development can be determined. Only when item 4 is accomplished can consideration be given to modification of item 3 requirements. Conduct a shear stress analysis for a specific site by undertaking the following:
- a) Conduct catchment modelling, i.e. continuous simulation, using land use, initial losses and time of concentration for the catchment in the pre-development condition without the proposed project. Another simulation will then have to be undertaken for the catchment with the development in place.
 - b) Input climate information including evaporation data and long-term rainfall.
 - c) Identify a typical downstream cross-section, slope bed material and channel roughness. Where a model is being applied, if the receiving environment has an existing HCC Watercourse Assessment or Rapid Geomorphic Erosion Assessment Report, the results of this report should be used to inform the model of channel variables including: channel geometry, bed material and bank material.
 - d) Apply standard channel hydraulics to the cross-section to get a relationship between the discharge and shear stress.
 - e) Develop the relationship between shear stress and erosion rate.
 - f) Combine this with the discharge/shear stress relationship to get a discharge/erosion relationship.
 - g) Apply the output hydrographs from the hydrological simulations to get the discharge/erosion curve to get the long-term time series of erosion rate.
 - h) Calculate the long-term erosion with and without the new project to determine whether the intended development will make erosion worse.
 - i) Council could allow for another method of calculating erosion potential through the use of NIWA's 2004 A Guide for Assessing the Effects of Urbanisation on Flow-related Stream Habitat.

Volume control uses the same volumes as recommended for detention but then infiltrates or otherwise uses (water tanks, designed evapotranspiration) the runoff.

Stream erosion issues are applicable where:

- There is a natural stream, and
- Catchment imperviousness exceeds 3%, and
- There is potential for future development to increase stream channel instability, and

- There is no tidal influence to the stream where the new development discharges to it.

7.2.8 Lands within and draining into Hamilton City Council jurisdiction

It may not always be possible to have sufficiently detailed information to model channel velocity and then define when the threshold is reached as per table 7-3 and as described in Section 7.2 “to develop and discharge/erosion relationship” to define an appropriate extended detention volume. This is particularly true of urbanised channels which display a high degree of channel cross sectional variability (constriction/expansion), via modification, infilling, lining and straightening. This results in high velocity variability and localised scour e.g. Erosion hot spots.

Therefore, a precautionary approach is preferred for all channel types as listed in Table 7-3, within and draining to Hamilton City, other than those channels which are lined both bank and bed or are bedrock bank and bed. This would simply mean all other channels require some level of protection / resilience works and extended detention volume as per 3b above of Section 7.2.7 should be calculated and applied.

Additionally, where catchment development results in an increase in discharge rate, the volume, frequency and event period also increase. On this basis channel protection / resilience works are likely required as erosive force is increased and the channel is assumed to be affected by residual effects.

Stream protection / resilience measures may be in the form of protecting banks and bed through remedial works, such as planting, green treatments, such as biodegradable geotextiles and as required more engineered solutions, including grade control structures and bank strengthening.

Within Hamilton City Council jurisdiction limits this may mean the requirement for a financial contribution to erosion prevention / watercourse resilience works, via a Development Contribution or similar.

7.3 Water quality design

There are several items that need to be considered when discussing stormwater quality design. These items include:

- General sizing requirements
- Effluent limits versus best practicable option (BPO)

7.3.1 General sizing requirements

The size of stormwater runoff event to be captured and treated is a critical factor in the design of stormwater quality treatment devices. If the design runoff event is too small, the effectiveness of the device will be reduced because too many storms will exceed the capacity of the device. If the design event is too large, the smaller runoff events will tend to empty faster than desired or the cost of the device will be greater than the benefit that it provides.

Analytical work to determine optimal policies for rainfall capture⁸⁹ has indicated that there is a maximised point of runoff volume capture at approximately the 90th percentile storm. The 90th percentile storm is that storm that 90% of all storms on an annual basis are less than. The use of the 90th percentile storm has become widespread throughout the United States.

In the Auckland Region, similar work was undertaken based on rainfall information taken from the Botanic Gardens at Manurewa from 1983 to 1990⁹⁰. The frequency distribution of rainfall for events greater than 2 mm is shown in Figure 7-5.

⁸⁹ Clar et al, 2004

⁹⁰ Auckland Regional Council, 1992

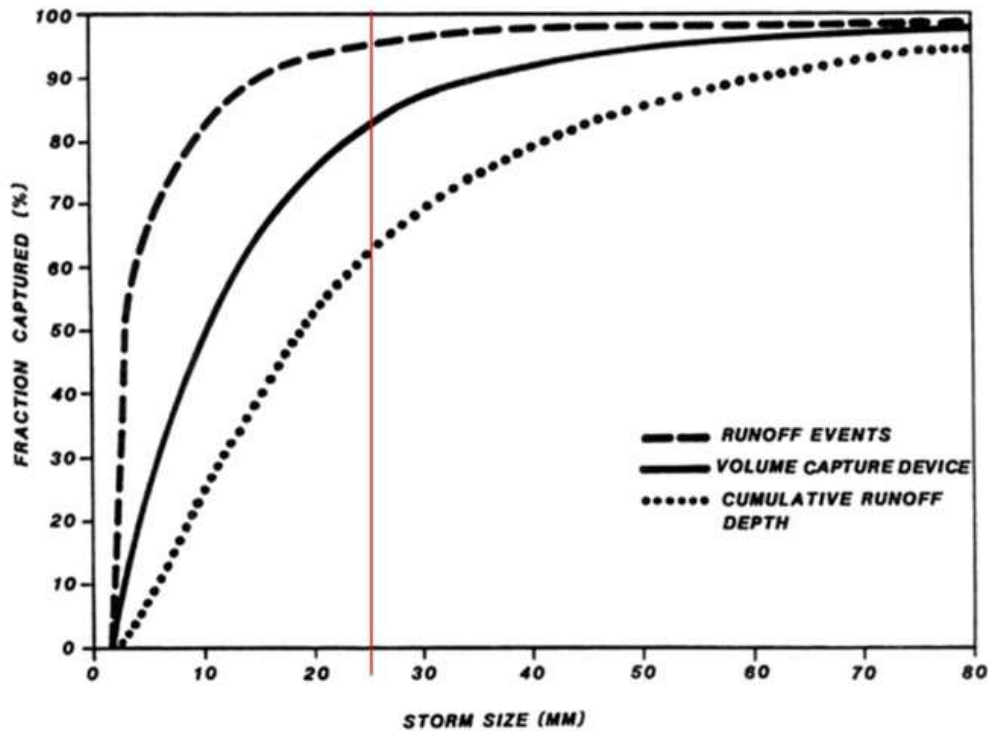

Figure 7-5: Frequency distribution of runoff events⁹⁰

As an example of the information gained by the use of this figure, the distribution indicates that for a storm depth of 25 mm:

- 95% of events would have a lesser depth
- 80% of the storm volume would be captured if a device could capture up to 25 mm of rainfall
- Events with a total rainfall depth less than 25 mm have a cumulative rainfall depth of 60% of total rainfall.

Rainfall in the Waikato Region is highly variable. Figure 7-6 shows the 90th percentile storm distribution in the Waikato Region⁹¹.

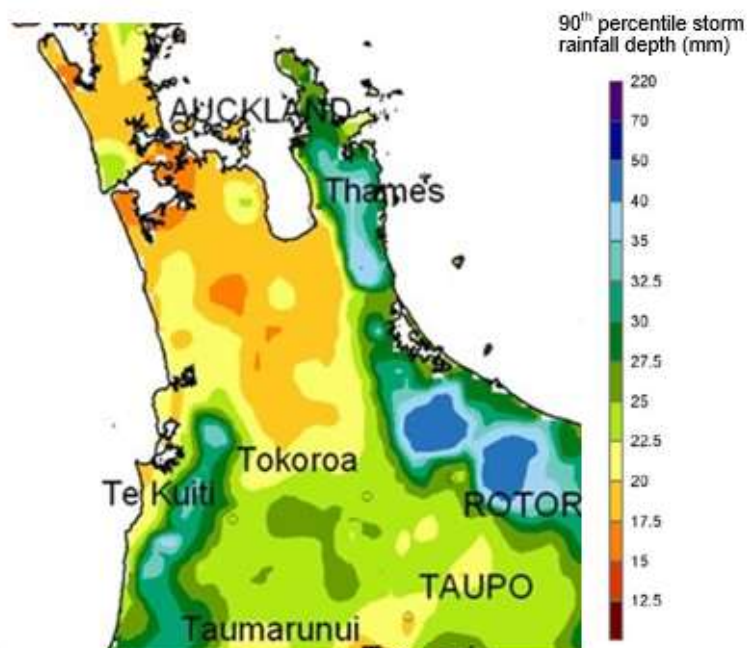

Figure 7-6: 90th percentile storm at different locations within the Waikato Region⁹¹

⁹¹ New Zealand Transport Agency, 2008

A good representation of the 90th percentile storm in a specific location can be found by using NIWA's High Intensity Rainfall Design System (HIRDS) Version 3 where 1/3 of the 2-year 24-hour rainfall event for a given latitude/longitude approximates the 90th percentile storm.

7.3.1.1 Water quality volume design

The water quality volume is the stormwater runoff volume determined by calculating the runoff volume from 1/3 of the 2-year 24-hour rainfall (including an allowance for climate change) at a given location. If the water quality rainfall exceeds 30 mm then 30 mm should be used to calculate water quality volumes. The reasoning for this relates to the steep nature of catchment slopes in portions of the region where higher intensity rainfall occurs (i.e. the Coromandel Peninsula) and the difficulty in sizing practices on those slopes that would need to meet greater rainfall/runoff volumes.

From this point on this volume will be identified as the water quality volume.

7.3.1.2 Water quality flow through rates

Devices that rely on stormwater flowing through them (in this case proprietary devices) that rely on flow rate should be based on 10 mm/hour. This will ensure that approximately 90% of storms are treated.

7.3.1.3 Nutrient removal

If nutrients are a concern in a lake catchment, or where there are groundwater contaminant issues, it is important that adequate water quality treatment is provided to ensure the nutrients are removed and that they don't accumulate in the lake or groundwater. Hence it is considered that two devices in series are required to achieve adequate nutrient removal in sensitive lake catchments. Where nutrient management requires two or more devices in series, it is important that the initial device relies on aerobic removal processes prior to the most downstream device, which focusses on nutrient removal via anaerobic processes.

Processes that normally occur in an aerobic environment include those practices for which the following processes occur:

- Sedimentation,
- Filtration and adsorption,
- Biofiltration, and
- Precipitation.

These practices include swales, filter strips, bioretention and ponds.

Processes that normally occur in an anaerobic environment rely upon microorganisms reducing soluble BOD and break down nutrients and organic compounds. In anaerobic conditions, microorganisms can remove nitrogen by de-nitrification. Microbial decomposition of organic matter produces reduced NH₃ (ammonia) which is treated commonly through biological oxidation to NO₂/NO₃ (nitrogen dioxide/nitrate) and then treated by biological reduction anaerobically to N₂ (nitrogen gas). Wetlands and to a more limited extent bioretention practices are the only ones that provide significant removal of nitrogen from stormwater.

It is important that appropriate devices are selected that target removal of the contaminants of concern. For example, wetlands achieve nitrogen removal through de-nitrification processes involving anaerobic conditions promoting de-nitrification, however pH can be reduced in wetlands causing other contaminants to mobilise such as phosphorus and heavy metals. Hence if phosphorus and nitrogen are a concern, then a device would be required that achieves phosphorus removal such as a raingarden, followed by a wetland to target nitrogen removal.

7.3.2 Effluent limits versus best practicable option

A common approach to determining compliance with consents is the use of a Best Practicable Option (BPO). Section 108(2)(e) of the Resource Management Act 1991 states that:

“A resource consent may include...a condition requiring the holder to adopt the best practicable option to prevent or minimise any actual or likely adverse effect on the environment of the discharge and other discharges (if any) made by the person from the same site or source”

As discussed in Section 1.3, generally a BPO approach is considered acceptable when determining a stormwater management system for a proposed development. However, there are situations where the sensitivity of the downstream receiving environment or the scale of proposed development necessitates a more determinative approach, i.e. a science based assessment of potential effects and development of a stormwater management system that ensures effects are mitigated accordingly.

Using a BPO approach that is in accordance with design guidance provided in this guideline is recommended. An applicant can propose an alternative approach to site development, however the applicant will be required to demonstrate that a comparable outcome is achieved, relative to the approach recommended in this guideline, in terms of mitigating and avoiding potential adverse effects to the receiving environment.

7.3.3 Water quality treatment criteria

The following requirements apply for stormwater quality design.

1. The water quality volume is the runoff volume from the 1/3 of the 2-year 24 hour rainfall event (including an allowance for climate change) at a given location.
2. The water quality volume should be used to determine storage volumes and flow rates to size stormwater management devices.
3. In areas where the water quality event rainfall is greater than 30 mm, water quality treatment should be designed using a rainfall depth of 30 mm to determine the water quality volume. This only applies to water quality criteria. Extended detention will require design for the full, un-adjusted volume.
4. Devices that rely on stormwater flowing through them (in this case proprietary devices) that rely on flow rate should be based on 10 mm/hour. This will ensure that approximately 90% of storms are treated.
5. Where nutrients are a contaminant of concern, for example in contained lake catchments, a treatment train approach must be used to improve nitrogen and phosphorus removal efficiencies. This is due to the limited ability of individual stormwater management devices to achieve significant removal of nitrogen and phosphorus on their own. This will necessitate at least two devices being used in series to improve nitrogen and phosphorus removal. Refer to Section 6.2.6 for more details about the use of a treatment train approach.

7.4 Summary of recommendations

The following summarises the key design criteria for managing stormwater runoff from urban areas that are acceptable to Waikato Regional Council.

7.4.1 Peak flow control

There are five requirements related to peak flow control criteria:

1. Rainfall data used for all rainfall events shall have 24-hour rainfall distribution.
2. The rainfall data for the 2, 10 and 100-year ARI events should be increased for the post-development scenario to allow for predicted climate change in accordance with Section 7.1.6.
3. Where there are existing downstream flooding issues, depending on the site's position in the catchment (refer to Section 7.1.3), it is recommended that the post-development peak discharge for the 100-year ARI rainfall event for a new development be limited to

80% of the pre-development peak discharge (unless there is a catchment study that demonstrates that this is not required).

4. In terms of intermediate storm control, depending on the site's position in the catchment (refer to Section 7.1.3), the 2 and 10-year ARI post-development peak discharges shall not exceed the 2 and 10-year ARI pre-development peak discharges.
5. As discussed in Section 7.1.3, peak flow control is generally only recommended for projects located in the top half of catchments so as to avoid concerns over coincidence of peaks aggravating downstream flooding concerns. It is expected that stormwater design will be undertaken by experienced stormwater practitioners who will be able to determine whether peak flow control is required. If there is confusion regarding whether peak flow control is required, Waikato Regional Council staff can be contacted to discuss further.

7.4.2 Stream erosion control

There are four different approaches that address stream channel erosion:

1. It is recommended that the difference between the pre- and post-development total volume for smaller storms up to the 2-year ARI event be retained (rainwater re-use, soakage or bioretention) where possible. There will be situations where this volume cannot be retained on site due to slope, water table or soil conditions. A minimum retention of the site pre-development initial abstraction from all impervious areas should be provided. If soil conditioning is not provided for intended pervious areas that have been earth-worked then the initial abstraction of runoff from the entire site should be retained as per the following method.

The initial abstraction is rainfall and converting it to a volume of runoff for impervious surfaces is straightforward where the rainfall is assumed to be directly converted to runoff with no reduction in the amount. For pervious areas that are not rehabilitated, additional analysis is necessary. In those situations:

- The pre-development runoff curve number (CN) is used to calculate the initial abstraction (I_{a1}) for the pervious areas.
- The post-development CN should be determined assuming that the soil group is altered to account for soil disruption and compaction where rehabilitation is not going to be done. Thus, a group A soil should be considered as a B soil in the post-development scenario (similar to a B becomes C, C becomes D). The initial abstraction (I_{a2}) is based on the altered soil grouping due to compaction.
- The required runoff retention due to soil compaction of the pervious areas is the following:

$$V_r = (I_{a1} - I_{a2}) \times (A)$$

I_{a1} = pervious area initial abstraction in (m) for pre-development soils as determined by the Section 5.1 of the Waikato Stormwater Runoff Modelling Guideline.

I_{a2} = pervious area initial abstraction for post-development soils where soil rehabilitation has not been done in (m). The initial abstraction shall also be as determined by Section 5.1 of the Waikato Stormwater Runoff Modelling Guideline.

A = post-development compacted pervious surface area in (m²).

V_r = stormwater runoff volume (V_r) for pervious areas that should be retained (m³).

This volume is then combined with the impervious area retention volume to arrive at a total site retention volume.

2. Check the 2-year stream velocities against Table 7-1 to ensure that velocities are non-erosive. If they are non-erosive in the post-development condition assuming maximum probable development of the catchment, then no extended detention is required. If stream velocities are predicted to be erosive then criteria are provided in items 3 and 4 below.
3. Implement extended detention or volume control according to the following:
 - a) If the stream is stable under the existing development condition, design detention or retention storage for a 24-hour release of an equivalent volume to the water quality storm.
 - b) If the stream is not stable (refer to Section 7.2.5 above for further discussion), multiply the water quality volume by 1.2 to determine the extended detention volume. That volume is then stored and released over a 24-hour period.
 - c) The relationship between initial abstraction (I_a) and the water quality volume and extended detention should be considered jointly. The water quality volume and the extended detention volume can be reduced by the retained initial abstraction volume (if retained within public spaces, not on-lot). If retention is provided for the full 2-year ARI event for a site, then no extended detention is required for smaller storms, and water quality would be considered to be addressed as well.
4. This item is for those situations where catchment development has already essentially been completed or for growth cell planning where a large proportion of the catchment is proposed to be developed and the effects of one more development can be determined. Only when item 4 is accomplished can consideration be given to modification of item 3 requirements. Conduct a shear stress analysis for a specific site by undertaking the following:
 - a) Conduct catchment modelling, i.e. continuous simulation, using land use, initial losses and time of concentration for the catchment in the pre-development condition without the proposed project. Another simulation will then have to be undertaken for the catchment with the development in place.
 - b) Input climate information including evaporation data and long-term rainfall.
 - c) Identify a typical downstream cross-section, slope bed material and channel roughness.
 - d) Apply standard channel hydraulics to the cross-section to get a relationship between the discharge and shear stress.
 - e) Develop the relationship between shear stress and erosion rate.
 - f) Combine this with the discharge/shear stress relationship to get a discharge/erosion relationship.
 - g) Apply the output hydrographs from the hydrological simulations to get the discharge/erosion curve to get the long-term time series of erosion rate.
 - h) Calculate the long-term erosion with and without the new project to determine whether the intended development will make erosion worse.
 - i) Council could allow for another method of calculating erosion potential through the use of NIWA's 2004 A Guide for Assessing the Effects of Urbanisation on Flow-related Stream Habitat.

Volume control uses the same volumes as recommended for detention but then infiltrates or otherwise uses (water tanks, designed evapotranspiration) the runoff.

Stream erosion issues are applicable where:

- There is a natural stream, and

- Catchment imperviousness exceeds 3%, and
- There is potential for future development to increase stream channel instability, and
- There is no tidal influence to the stream where the new development discharges to it.

7.4.3 Water quality treatment

The following recommendations are made:

1. The water quality volume is equivalent to the stormwater runoff volume from 1/3 of the 2-year 24-hour rainfall event (including an allowance for climate change) across a defined area at a given location.
2. The water quality volume should be used for determining storage volumes and flow rates in sizing stormwater management devices.
3. In areas where the rainfall for the water quality event is greater than 30 mm, a rainfall depth of 30 mm can be used to determine the water quality volume for water quality treatment. This only applies to water quality. Extended detention will require design for the full-unadjusted rainfall depth.
4. Devices that rely on stormwater flowing through them (in this case proprietary devices) that rely on flow rate should be based on 10 mm/hour. This will ensure that approximately 90% of storms are treated.
5. Where the receiving environment has existing nutrient issues (for example in contained lake catchments) at least two devices should be used in series to improve removal of nitrogen and phosphorus from the stormwater discharge. It is important that aerobic processes occur prior to anaerobic processes to prevent resuspension of other contaminants.

8 Stormwater management device design

8.1 Introduction

The sections up to now have provided the foundation for the need to consider stormwater management, the types of devices that can be used, analytical approaches and recommendations for the form that management should take from a flooding, erosional and water quality perspective. This section is devoted to detailed design approaches for stormwater quantity and quality control.

The section will be broken up to discuss several different areas as follows:

- Source control
- Designing for ease of operation and maintenance
- Designing for safety, and
- Flow and treatment control.

8.2 Source control

Prior to any consideration of stormwater treatment, consideration should be given to source control and a series of questions answered:

- Have building materials been used that minimise leaching of contaminants?
- Has existing vegetation been preserved to the degree practicable or has vegetation been re-established upon project completion?
- Are flow velocities and volumes increased downstream (energy dissipation)?
- Has slope disturbance been minimised and have disturbed slopes been vegetated and slope lengths minimised through the use of cut-off drains?
- Can concentrated flow areas be minimised?
- Are any cross drains combined and considered for erosion protection?

When these types of questions have been considered and addressed, the stormwater management device selection process then moves on to flow and treatment control.

8.3 Designing for ease of operation and maintenance

As well as water quality and water quantity control, another key element that must be considered during the design phase is operation and maintenance of the device. There are several key elements that must be considered during the design phase. Asking and answering some questions or giving serious consideration to operation of the stormwater device and system can answer them.

- Spend a year at the device
- Asking maintenance questions such as who, what, when, where and how, and
- Considering the use of uniform materials or components.

8.3.1 Spend a year at the practice

The stormwater designer must imagine conditions at the completed device throughout an entire year. This should not only include rainy and sunny weather but also consider time of year when evapotranspiration rates are different. Other site conditions may include hot, dry weather or drought when vegetation is stressed or dies. Finally, for safety purposes, the designer should also imagine what the system would be like at night.

As these conditions are visualised, the designer should also imagine how they might affect not only the operation of the device itself, but also the people that will maintain it or otherwise interact with it. Will the outlet structure trash rack be prone to clogging from vegetation or debris floating in the stormwater runoff? Is there a safety issue related to maintenance for maintenance employees?

This approach is intended to assist the designer to consider and design for possible conditions at the practice, not just for specific storm events.

8.3.2 Maintenance questions

Another key element of design should involve asking specific questions that focus on operation and maintenance characteristics or functions of the practice. The questions should include at least:

1. Who will perform the maintenance?

Does the design of the device require operation and maintenance specialists or will someone with general maintenance equipment and training be able to accomplish it?

2. What needs to be maintained?

A list of device components that are part of the design may prompt a revised design with either a shorter list or one that modifies a device component to facilitate maintenance. An example of this could be a sand filter system that has heavy covers that are not easily removed by hand or require a specialised piece of equipment to lift the covers.

3. When will maintenance need to be performed?

Does maintenance have to be undertaken once a day, once a week, monthly or annually? The recurring costs of maintenance can be substantial. In addition, can maintenance only be undertaken during dry weather? If so, what happens during the lengthy time periods of wet, rainy weather? In terms of effort and possible consequences, it is easier for the designer to provide answers to these questions now rather than having the maintenance personnel having to develop an approach later.

4. Where will maintenance have to be performed?

Recognising that these devices/practices are being implemented for new developments within larger development areas, there will always be potential interaction with the public and safety concerns that have to be addressed. Will the maintainer be able to gain easy access to the device? Once there, will they have a stable, safe place to stand and work? Can the design provide a means for the maintenance contractor to reduce the time on site to conduct maintenance inspections and perform maintenance?

5. How will maintenance be performed?

The simple instruction to remove sediment or harvest vegetation can become complicated if there hasn't been any provision made to allow equipment access to the device or even to the site. Are locks used to limit public access to a practice? If security features are used then there has to be a common key to allow easy access. Stormwater devices cannot become a liability to the local community.

8.3.3 Uniform materials or components

Specify materials that will last for as long as the life expectancy of the stormwater management device might be. If further development is anticipated in 15 years then materials used should last 15 years. Reducing construction costs may have a significant adverse impact on long-term maintenance costs.

It is absolutely essential that the designer consider these issues during the design phase so they can be addressed now rather than being left for later resolution. The design phase may be the shortest amount of time given to a given project when considering construction time and whole-

of-life aspects of a development and its stormwater management practices. It is vital that the design attempts to minimise future maintenance obligations and cost while providing for proper protection of downstream areas.

8.4 Designing for safety

As discussed in Auckland Council's GD01⁹², safe design, integrating health and safety risk identification and assessment methods through the design, should begin early in the design process to eliminate or minimise the risk of death, injury or illness to those who may interact with stormwater management assets. The goal is to eliminate hazards wherever possible. Where this cannot be achieved, the risks are to be minimised as much as practicable.

Construction site-safety risk management is essential. However the opportunity to eliminate or reduce a hazard in the design stages, by involving decision makers and considering the life cycle of the project, is invaluable in reducing safety risks. This requires effective collaboration between designers, health and safety professionals, operation and construction staff and other parties such as developers and project managers.

Safe design begins in a projects conceptual and planning phases with emphasis on making the right choices about the design, methods of construction, on-going operation and maintenance and materials. Any residual risks remaining at the end of the design phase should be identified to allow them to be addressed or managed during the projects next phases.

Table 9 in Auckland Council's 'Stormwater Management Devices in the Auckland Region' presents some examples of safety in design considerations.

8.5 Specific design guidance for stormwater management devices

Specific design guidance is provided in this section for the following devices:

- Swales
- Filter strips
- Sand filters
- Bioretention
- Infiltration
- Wet ponds
- Wetlands
- Green roofs
- Water tanks
- Conditioning of soil
- Oil and water separators

These devices are all considered applicable for new development. Prioritisation of this list is difficult as each device has value, but one or more may be more appropriate in a given catchment.

For example, swales, filter strips, sand filters, bioretention devices and oil and water separators are primarily water quality devices with limited ability to address water quantity issues.

Wet ponds and wetlands can provide good water quantity control but wet ponds have a limited ability to remove hydrocarbons and soluble metals.

⁹² Cunningham A et al, 2017

One device that is good for both water quantity control and water quality treatment is a wetland. A wetland's organic substrate, density of vegetation and ability to provide live storage for water quantity control makes them suitable for both water quantity control and water quality treatment. The major drawbacks of a wetland is the area that it requires and the need to have a catchment area large enough to support hydric soils. Wetlands should be considered whenever water quality treatment, peak control or stream erosion protection is a design objective.

8.5.1 Swales



<p>Description: Swales are broad grassed channels used to treat and convey stormwater runoff.</p> <p>Swales help to filter sediments, nutrients and other contaminants from stormwater before discharge to receiving environments. Swales treat stormwater runoff by the following:</p> <ul style="list-style-type: none"> • Filtration • Infiltration • Adsorption, and • Biological uptake. 	Stormwater Management Function	
	<input checked="" type="checkbox"/>	<p>Water quality</p> <p><input checked="" type="checkbox"/> Metals</p> <p><input checked="" type="checkbox"/> Sediment</p> <p><input type="checkbox"/> TPH</p>
	<input type="checkbox"/>	Flood protection
	<input type="checkbox"/>	Stream channel erosion protection

Swales provide water quality treatment and can also be used to convey stormwater runoff in place of a conventional piped reticulation system. Swales are generally constructed using in situ topsoils, rather than engineered media. Hence whilst they may provide limited infiltration of runoff, they are not primarily designed for this purpose. Bioretention swales are constructed using engineered bioretention media to enable retention of runoff, these are discussed further in Section 8.5.4.

Swales are a very appropriate device to use adjacent to roads and throughout new developments. They can easily occupy a linear corridor without taking up much additional space. Although swales may vary in their purpose in different areas, their overall objective is to convey and treat stormwater, slow stormwater flows and provide limited infiltration of stormwater runoff (if the swale is unlined).

Water quality treatment is provided by passing stormwater flows through vegetation. Passage through vegetation and providing contact with organic matter allows physical, chemical and biological processes to occur that reduce contaminant delivery downstream.

8.5.1.1 Basic design parameters

Site suitability should be based upon the parameters provided in Table 8-1.

Table 8-1: Site suitability parameters

Parameter	Limitation
Swale catchment area	Swales are suitable small / medium sized catchments, generally 3 hectares or less in size.
High sediment loadings	High sediment loadings will clog up the swale invert and promote concentrated flows, which degrade water quality function. Swales should be protected from high sediment loads with pre-treatment. Dense planting and level spreaders at inlet can reduce sediment loads.

Parameter	Limitation
Swale slope	Swales should have a longitudinal slope less than 5% unless check dams are used to reduce overall slope.
Soils	Swales can be implemented in any soil although karst geology may require an impermeable liner on the swale invert to avoid instability issues.
Groundwater	Swale invert should not intersect with seasonal high groundwater. Swale base should be more than 1m above the seasonal high groundwater level. Where swales are intended to intersect groundwater, they should be designed as wetland swales (refer to Section 8.5.7.3 for further details about wetland swales).
Setback	Swales >1m from a property boundary should have a lined vertical surface if within 5m of structures. Swales should not be within 3m of a structure.

The following Table 8-2 should be used for swale design elements.

Table 8-2: Swale design elements

Design parameter	Criteria
Longitudinal slope	< 5%
Water quality event velocity	Maximum velocity: 0.8 m/s Flow depth: 100mm maximum for grassed swales and 300mm for vegetated swales
10 year ARI event	Maximum velocity: 1.5m/s unless erosion protection is provided. Flow depth: 150mm below top of swale (unless swale is part of overland flowpath)
Inflow points	Usually a slotted kerb. Care should be taken to ensure sheet flow from the catchment is directed to the swale through inflow points. Where concentrated flows enter the swale (from pipes) level spreaders shall be placed at the head of the swale to disperse flows.
Vegetation	Grass or vegetated If vegetated plants should be selected that are tolerant of both drought and inundation and that don't shed leaves.
Maximum water depth above vegetation	The water quality design water depth should <u>not</u> exceed design height for grass. This is a key criterion for ensuring Manning roughness coefficient is provided.
Design vegetation height*	100 - 150 mm
Manning coefficient	0.25 for WQ storm, 0.03 for submerged flow (10-yr. Storm)
Minimum hydraulic residence time	9 minutes
Maximum bottom width	2 m
Minimum length	30 m
Minimum swale bottom width	0.3 m
Maximum catchment area served	3 hectares
Maximum lateral slope	0%
Maximum side slope	4 H:1V (shallow as possible for mowing purposes)
Longitudinal slope	Swales are not suitable on slopes greater than 8% Slopes of 5-8% require check dams Swales on slopes less than 2% require an underdrain

Design parameter	Criteria
Check dams	Required when longitudinal slope is >5% to reduce velocities. Maximum height to equal the depth of flow for the water quality event (recommended 100mm minimum for grassed swales)
Underdrain (not always present)	Required when longitudinal slope of a grassed swale is <2%, optional in other instances. Recommended where local soils have poor infiltration, to prevent stagnation and saturation of swale base. Underdrains are buried under the swale channel to capture filtered stormwater (usually a perforated pipe) and connect directly to the catch pit or stormwater manhole. Access must be provided for backwashing slotted drain.
Outlet	Outlets are usually a catchpit with a flat grate or a scruffy dome

* This applies to normal grasses. Other vegetation, such as Oioi can provide improved performance with reduced maintenance frequency.

There are several points that need further discussion and they include:

- Residence time
- Manning's coefficient of roughness, and
- Lateral inflow.

8.5.1.2 Residence time

A key factor in vegetated swale water quality performance is the residence time that the water takes to travel through the swale. Residence time depends on the following items:

- The longitudinal slope of the swale,
- The cross-sectional area of the swale, and
- Velocity of the flow

The velocity of flow is a function of the flow area, slope and frictional resistance of the vegetation and a common equation for calculating velocity is Manning's Equation.

$$V = R^{0.67} s^{0.5} / n$$

Where:

V = Average velocity in metres/sec.

R = the hydraulic radius of the swale in metres

s = slope of the swale in metres/metre

n = Manning coefficient of roughness

Residence time can then be determined by the following equation:

$$t = L/V$$

Where:

t = residence time in minutes (divide result by 60 sec/m)

V = velocity of flow at the design rate of flow in metres/sec.

L = swale length in metres

There have not been many studies that relate water quality performance in swale design. The most recognised work has been undertaken in the U.S.⁹³. That study recommended a residence of 9 minutes for flow to pass through the swale and provide approximately an 80% removal of total suspended solids. Most government agencies in the United States have adopted that

⁹³ Metropolitan Seattle, 1992

criterion. **A 9 minute residence time is recommended for use to design swales in the Waikato Region.**

As discussed in Section 8.5.1.4, depending on how the swale is configured, there may be areas in the upper part of the swale that exceed the required residence time, and areas in the lower portions of the swale where residence time may not be met. It is required that an average residence time of 9 minutes is achieved.

Residence time is seemingly more important for sediment reduction than it is for nutrient reduction. Investigations in Brisbane⁹⁴ have indicated that concentrations of total suspended solids continue to decrease over swale length and do not reach an asymptote. For total phosphorus and total nitrogen, however, there is a very rapid decrease in concentration within the first quarter of the swale length, after which a relatively constant concentration is maintained.

8.5.1.3 Manning’s coefficient of roughness

Determining roughness coefficients is more art than science. Many design handbooks provide one value for Manning’s coefficient of roughness of 0.2⁹³ or 0.25⁹⁵. Auckland Regional Council funded a study⁹⁶ where dye tests were undertaken on a swale to determine “n” by measuring flow times through the swale. In all of the test trials the values of Manning’s coefficient of roughness varied from 0.18 - 0.30.

It is recommended that a standardised value for Manning’s roughness coefficient of 0.25 be used when designing swales.

For the 10-year ARI event analysis, it is assumed that the vegetation is submerged so the coefficient of roughness is reduced accordingly. The value selected is 0.03 for flow above grass elevation⁹⁷.

8.5.1.4 Swale inflow

There are two common ways that flow enters swales: via concentrated flow or dispersed lateral inflow. Where there is concentrated inflow, erosion control should be used similar to that shown in Figure 8-1 below. In addition to lateral flow diversion, Figure 8-1 also illustrates the use of check dams along a swale.

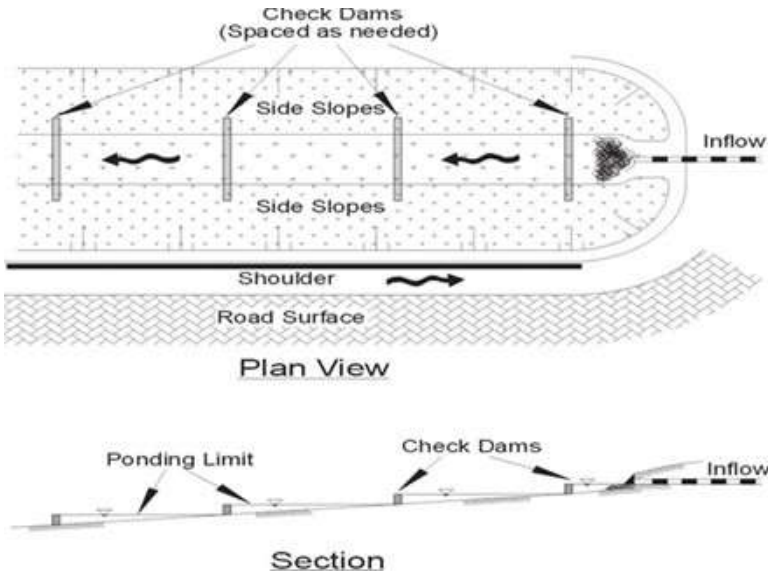

Figure 8-1: Swale with check dams and diversion of lateral inflow⁹⁸

⁹⁴ Fletcher et al, undated
⁹⁵ California Stormwater Quality Association, 2003
⁹⁶ Larcombe, 2003
⁹⁷ Chow, 1959
⁹⁸ Auckland Regional Council, 2003

A common concern with swales having lateral inflow from site areas is that the entire flow does not achieve the 9-minute residence time. It is required that an average residence time of 9 minutes is achieved. There will be areas in the upper part of the swale that may exceed the required residence time, and areas in the lower portions of the swale where residence time may not be met, however the average residence time is appropriate in light of the benefits that swales provide.

8.5.1.5 Detailed design procedure

The design approach takes the designer through a series of steps that consider swale performance for water quality treatment and consideration of larger flows to ensure that scour or resuspension of deposited sediments does not occur.

1. Estimate runoff flow rate from the water quality storm. One difference between swale and filter strip design and other stormwater management devices is that they are designed by flow rate, which is based on 1/3 of the 2-year 24-hour rainfall event. Other devices are designed by calculation of the water quality volume.

As an additional guidance note relevant to designing swales, wetland swales and filter strips, it is necessary to assess the peak velocities for the water quality event, to ensure the devices are adequately sized. To enable the impact of retention to be incorporated into this assessment, it is recommended that the designer assumes the impervious surfaces have an initial abstraction that is equal to the pre-development initial abstraction, and calculate the peak flow rate, and then velocity, on this basis.

2. Establish the longitudinal slope of the swale.
3. Select a vegetation cover. It should be grass and would generally be either perennial rye or fescue.
4. The value for Manning's coefficient of roughness is 0.25
5. Select a swale shape. Two shapes are proposed as they ensure distributed flow throughout the bottom of the swale. Triangular swales are not recommended as they concentrate flow at the bottom of the swale. Channel geometry and equations for calculating cross-sectional areas and hydraulic radius are provided under the individual configurations in Figure 8-2.
6. An assumption is made on the depth of flow in the swale for the water quality storm. This assumed depth is used for calculating the bottom width of the swale and cross-sectional area.
7. Use Manning's equation for calculating dimensions of the swale by using first approximations for the hydraulic radius and dimensions for selected shape.

$$Q = AR^{0.67}s^{0.5}/n$$

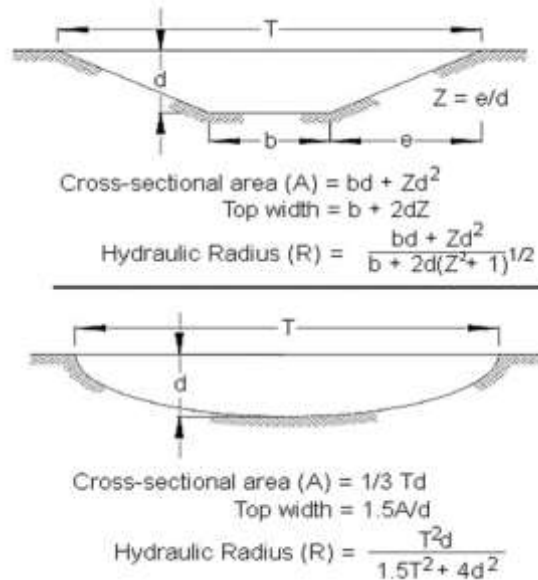

Figure 8-2: Swale channel geometry⁹⁹

By making some assumptions about depth and width ratios such as the hydraulic radius for a trapezoid approximating the depth (d), the bottom width of a trapezoid (b) equals the following:

$$b = (Qn/d^{1.67}s^{0.5}) - Zd$$

The slope, depth, discharge and side slope are all known and b can be determined.

Where:

- Q = Design discharge flow rate (m³/s)
- N = Manning's n (dimensionless)
- s = Longitudinal slope (m/m)
- A = Cross-sectional area (m²)
- R = Hydraulic radius (m)
- T = Top width of trapezoid/parabolic shape (m)
- d = Depth of flow (m)
- b = Bottom width of trapezoid (m)

For a parabola, the depth and discharge are known so the top width can be solved for.

8. Knowing b (trapezoid) or T (parabola), the cross-sectional area can be determined by the equations in Figure 8-2.
9. Calculate the swale velocity from the following equation:

$$V = Q/A$$

If $V > 0.8$ m/s repeat steps 1 - 9 until the velocity is less than 0.8 m/s.

10. Calculate the swale length (L in metres)

$$L = Vt(60 \text{ s/minute})$$

Where:

t = residence time in minutes.

8.5.1.6 Flows in excess of the water quality storm

It is expected that runoff from events larger than the water quality design storm will go through the swale. In that situation, a stability check should be performed to ensure that the 10-year, 24 hour ARI event does not cause erosion. For the 10-year storm, flow velocities should not exceed

⁹⁹ Auckland Regional Council, 2003

1.5 m/s, although higher velocities may be designed for with appropriate erosion protection. The design must allow for climate change, refer to Section 7.1.6.

8.5.1.7 Shallow or steeper slope situations

Where slopes are less than 2%, an underdrain must be used to prevent soils from becoming saturated during wet times of the year. Figure 8-3 provides a typical cross-section of the underdrain system ensuring that water passes through the invert of the swale, through a loam soil, then geotextile fabric and gravel prior to discharge through a 100 mm perforated pipe.

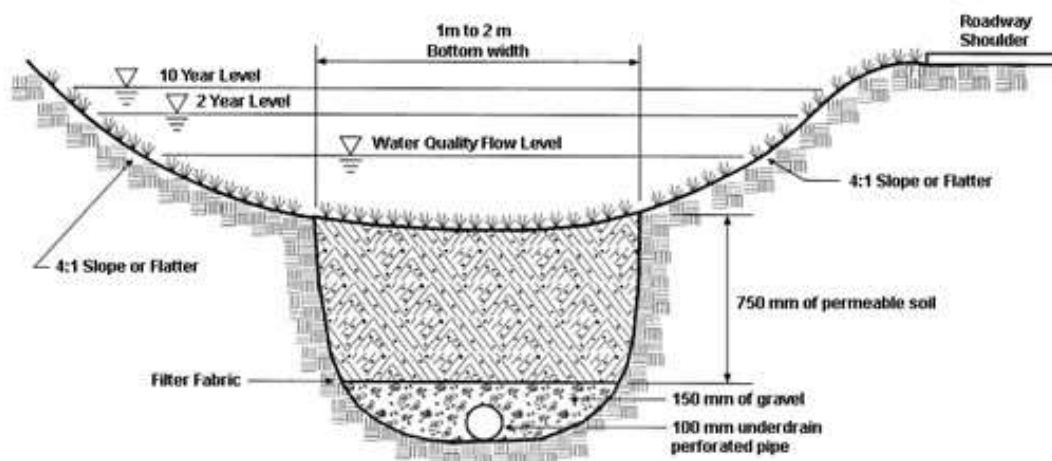

Figure 8-3: Swale schematic showing soils and underdrain¹⁰⁰

Using an underdrain can be one method to meet extended detention requirements. In this case, the extended detention volume can pass through the permeable soil with an assumption of total drainage time being 24 hours.

Where slopes exceed 5%, swales can only be used if check dams are included so that the ultimate post-construction slope between check dams is less than 5%. A key design element is that, as shown in Figure 8-1, the crest of the downstream check dam extends backwater to the toe of the upstream check dam. Consideration of higher flows shall be calculated as illustrated in the case study below and shown in Table 8-3. To determine the spacing between check dams the following equation is to be used.

$$L_{cd} = h_{cd}/s$$

Where:

L_{cd} = length between check dams (m)

h_{cd} = height of the check dams (m)

s = longitudinal slope

Determining the number of check dams required for the swale is determined by the following equation.

$$N = L/l_{cd}$$

Where

N = number of check dams

L = total length of the swale

l_{cd} = length between check dams

When using check dams it is important to ensure that scour does not occur at the toe of the check dams. If in doubt, erosion control measures such as stone should be placed at the toes of the check dams to ensure stabilisation.

Larger storms should be calculated assuming the storage behind the check dams is full and the overall slope of the flow would be the slope from the upstream top of the swale to the bottom.

¹⁰⁰ New Zealand Transport Agency, 2010

8.5.1.8 Vegetation

For the most part, vegetation will consist of either perennial rye or fescue grass. There may be other forms of vegetation that would provide comparable or improved treatment effectiveness with less maintenance requirements. One type of grass is Oioi (*Apodasmia similis*) that is a very dense grass that grows by rhizome and can become a thick filter media that you do not need to mow.



Swale using Oioi grass reduces maintenance and can be an attractive amenity

8.5.1.9 Case study - Swale

Project description

A small residential development in Huntly is proposed with its expected imperviousness being 50%. The development is two hectares in size with average lot sizes being 500 m². Predevelopment land use was a pasture and the average slope is 2%. Stormwater treatment for the site has a swale placed adjacent to one side of the site with all runoff traveling to that side.

Hydrology

Pre-development discharges

Using the Waikato Stormwater Runoff Modelling Guideline and using a temperature increase of 2.1°C assumption for post-development rainfall increase for climate change:

CN pre-development = 69 (orthic Brown Soil)

2-year 24-hour rainfall = 61.9 mm

10-year 24-hour rainfall = 92.7 mm

Pre-development 2-year peak discharge = 0.044 m³/s

Pre-development 10-year peak discharge = 0.096 m³/s

These values are not used in sizing of swales but they are important when peak flow control is required. Where required, retention or detention will be necessary, which will involve a device, or devices, to achieve peak flow control or extended detention.

Post-development discharges

Post-development discharges must include a climate change factor.

Pre-development rainfall – 2-year 24-hour rainfall = 61.9 mm

Pre-development rainfall – 10-year 24-hour rainfall = 92.7 mm

Adjustment factor for 2-year rainfall = 2.1 x 0.043 x 61.9 = 67.5 mm

Adjustment factor for 10-year rainfall = 2.1 x 0.063 x 92.7 = 105 mm

Water quality rainfall (1/3 of 2-year) = 22.5 mm

The swale will be designed for the water quality storm but must also be checked to ensure that 10-year non-erosive conveyance will be achieved.

As water volumes are not needed for design of swales, the post-development total site peak discharges are the only hydrological calculations required. The pervious areas will have soil remediation provided so that the pre-development curve number is unchanged at 69. $I_a = 5.7$ mm.

To calculate the impact that the increased initial abstraction retention has on water velocities, assume the impervious surfaces have an initial abstraction that is equal to the pre-development initial abstraction of 5.7 mm and calculate the peak flow rate. The increased initial abstraction for impervious surfaces has a very minor impact on the 10-year peak discharges that swales stability needs to be checked for.

$$\text{Post-development water quality flow rate} = 0.01 \text{ m}^3/\text{s}$$

$$\text{Post-development 10-year flow rate} = 0.17 \text{ m}^3/\text{s}$$

As there is minimal site grading, there is no significant compaction of pervious soils so the pervious post-development initial abstraction is maintained at 5.7 mm. The volumes associated with the initial abstraction on impervious surfaces results in a retention storage for impervious surfaces of 57.1 m^3 .

Swale Design

$$\text{Slope of swale alignment} = 0.015$$

Several assumptions have to be made regarding the swale, first of which is that the swale will have a trapezoidal design. Side slopes (Z) will then be recommended and an assumption of design storm depth should be made. That value may change depending on the velocity of flow being less than 0.8 m/s.

For this case study, $Z = 4$ and the depth of flow = 100 mm, which is also the design height of the grass.

Based on the value for Q and s, and the assumptions for n and d, solve for the swale bottom width (b).

$$b = (Qn/d^{1.67}s^{0.5}) - Zd$$

$b = ((.01)(.25)/(.1^{1.67})(.015^{0.5})) - (4)(.1) = 1.02\text{m}$ which indicates that the swale capacity does meet the minimum bottom width requirement. If the swale width had exceeded 2 m, the depth of vegetation could have been increased to 150 mm as long as the grass could remain standing during storm flow.

Calculate the top width

$$T = b + 2dZ = 1.02 + 2 (0.1) (4) = 1.82 \text{ m}$$

Calculate the cross-sectional area

$$A = bd + Zd^2 = (1.02) (0.1) + 4 (0.1^2) = 0.14 \text{ m}^2$$

Calculate the flow velocity

$$V = Q/A = 0.01 / 0.14 = 0.07 \text{ m/s}$$

which is well under than the 0.8 m/s maximum - good.

Calculate the swale length

$$L = Vt = 0.12 (540 \text{ sec.}) = 37.8 \text{ metres}$$

As the swale will probably have larger flows pass through it, the swale design can be adjusted to account for the larger flows. In this situation the Manning coefficient of roughness will have to be decreased, as flow will be above the grass height so assume $n = .03$ as the vegetation is completely submerged. Solve for d and ensure that velocities are not erosive. $Q_{10} = 0.17 \text{ m}^3/\text{s}$.

The following Table 8-3 relating flow depth to Manning's n to discharge provides information on swale flow under larger flow conditions.

Table 8-3: Flow depth vs. Manning's n versus discharge

Flow depth (m)	Manning's n	Discharge (m ³ /s)
0.1	0.25	0.01
0.1 - 0.3	0.03	0.17
Total Discharge		0.18

Even adding only 200 mm to the swale depth provides for conveyance considerably beyond the 10-year event of 0.17 m³/s. In terms of ensuring that the velocity is not greater than 1.5 m/s the swale design is adequate. The velocity for the 10 year storm using this swale configuration is 0.33 m/s, which is well under the 1.5 m/s maximum.

8.5.2 Filter strips



<p>Description: Filter strips are uniformly graded and densely vegetated to treat stormwater runoff by the following:</p> <ul style="list-style-type: none"> • Filtration • Infiltration • Adsorption, and • Biological uptake 	Stormwater Management Function	
		Water quality
	<input checked="" type="checkbox"/>	✓ Metals
		✓ Sediment
	~ TPH	
	<input type="checkbox"/>	Flood protection
	<input type="checkbox"/>	Stream channel erosion protection

Vegetated filter strips are vegetated areas that are designed to receive stormwater runoff as sheet flow from impervious areas. They are suitable for the treatment of stormwater runoff from small and frequent storms, effectively directing stormwater to landscape areas as passive irrigation.

The major difference between swales and filter strips is that swales accept concentrated flow while filter strips accept flow as distributed or sheet flow. Filter strip performance also relies on residence time that stormwater flows take to travel through the filter strip and the depth of water relative to the height of vegetation. Good contact with vegetation and soil is required to promote the operation of the various mechanisms that capture and transform contaminants, so spreading flow in minimal depth over a wide area is essential.

Depending on the residence time, a filter strip may function as a sole treatment device, or alternatively as a pre-treatment device capturing moderately coarse particles within a treatment train. Some portion of stormwater runoff may also infiltrate into the ground.

A key element of filter strips is that they rely on vegetation to slow runoff velocities. If stormwater runoff is allowed to concentrate, it effectively short-circuits the filter strip and reduces water quality benefits. Filter strips are simple designs that must withstand the full range of storm events without eroding.

8.5.2.1 Basic design parameters

The following Table 8-4 should be adhered to in designing a filter strip.

To be effective, filter strips require sheet flow across the entire strip. Once flow concentrates to form a channel, it effectively short-circuits the filter strip. Unfortunately, this usually occurs within a short distance for filter strips in urban areas. It is difficult to maintain sheet flow over a distance of 45 m for pervious areas and 23 m for impervious areas. This may be due in part to the inability to obtain evenly compacted and level soil surfaces using common construction

methodology. For some applications, a level spreader can be used to help ensure even distribution of stormwater onto the filter strip.

Table 8-4: Filter strip design elements

Design parameter	Criteria
Longitudinal slope	2% - 5%
Maximum velocity	0.4 m/s for water quality storm
Maximum water depth above vegetation	The water quality design water depth should <u>not</u> exceed ½ of the design height for grass. This is a key criterion for ensuring Manning roughness coefficient is provided.
Design vegetation height	100 - 150 mm
Manning coefficient	0.35 for WQ storm, 0.03 for submerged flow (10-yr. storm)
Minimum hydraulic residence time	9 minutes
Minimum length	Sufficient to attain residence time
Maximum catchment area served	2 hectares
Maximum lateral slope	2%
Where longitudinal slope < 2%	Filter strips are not recommended for slopes less than 2% unless they are designed for infiltration of runoff
Where longitudinal slope > 5%	Level spreaders shall be provided to ensure effective slope < 5%
Maximum overland flow distance uphill of the filter strip	23 m for impervious surfaces 45 m for pervious surfaces
Where concentrated flows enter the swale (from pipes)	Flows entering a filter strip cannot be concentrated. If this is the situation, level spreaders must be used to disperse flows
10-year storm velocities	< 1.5 m/s unless erosion protection is provided

8.5.2.2 Detailed design procedure

A schematic of a filter strip is shown in Figure 8-4. The schematic shows a collection trench and a level spreader if the flow is from a pipe. In this situation the dispersed flow is maintained across the width of the filter strip.

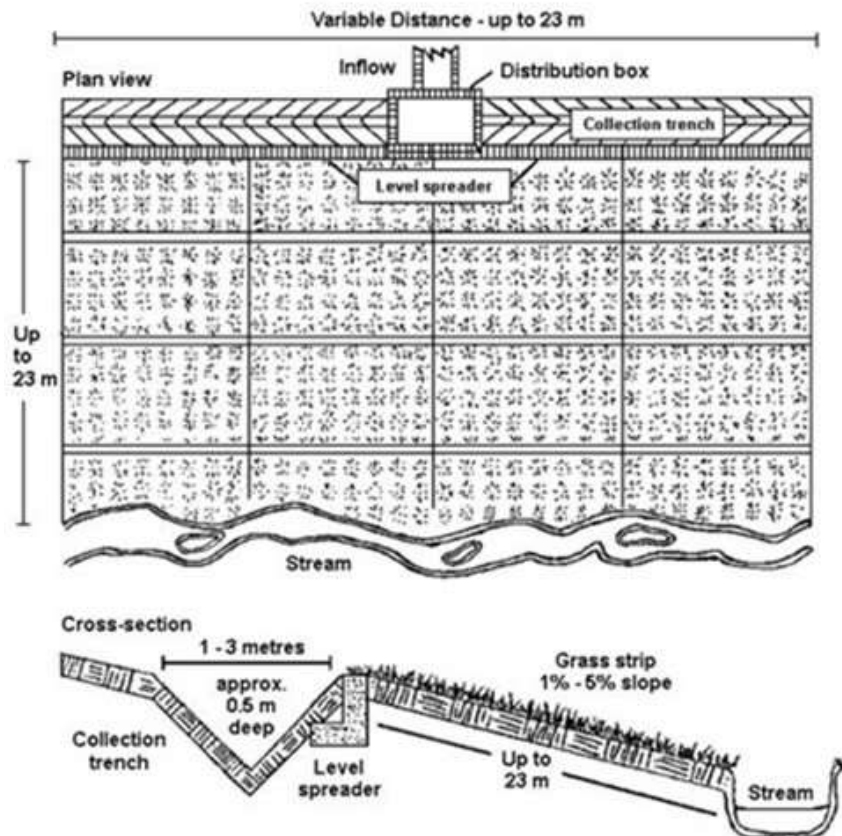

Figure 8-4: Schematic of a filter strip¹⁰¹

Design approach:

1. The first step is to calculate the discharge (Q) for the area draining to the filter strip.
As an additional guidance note relevant to designing swales, wetland swales and filter strips, it is necessary to assess the peak velocities for the water quality event, to ensure the devices are adequately sized. To enable the impact of retention to be incorporated into this assessment, it is recommended that the designer assumes the impervious surfaces have an initial abstraction that is equal to the pre-development initial abstraction, and calculate the peak flow rate, and then velocity, on this basis.
2. Once the peak discharge is determined, that discharge can be entered into Manning's equation to determine the width of the filter strip.

$$Q = AR^{0.67}S^{0.5}/n$$

Where:

A = Width of filter strip x depth of flow (determined by design grass height)

W = Width of filter strip in metres

R = Depth of flow (due to very wide flow)(in metres)

D = Depth of flow in metres = R

S = Slope

N = Roughness coefficient (0.35)

w is known from individual site conditions

$$\text{so } d = (Qn/ws^{-5})^{.6}$$

¹⁰¹ Delaware Department of Natural Resources and Environmental Control, 1997

3. Solve for d, based on knowing other design parameters and d must be less than 50 mm in depth.
4. $Q = AV$ where $A = wd$ so velocity of flow can be determined.
5. Once velocity is determined the length of filter strip can be determined by:

$$L = Vt$$

Where:

L = Length in metres

V = Velocity in m/s

T = Time in seconds (540 seconds for 9 minute residence time)

8.5.2.3 Case Study – Filter strip

Project Description

A residential home site is being constructed near Te Kauwhata with a filter strip to treat the access road in front of it. The slope of land adjacent to the access road is 3% and the road is 500 metres with a crown in the centre so the portion of road draining to the filter strip is 3.6 metres wide (1,800 m²).

Hydrology

Pre-development discharges

Using the Waikato Stormwater Runoff Modelling Guideline and using a temperature increase of 2.1°C assumption for post-development rainfall increase for climate change.

Pre-development land use is pasture.

CN pre-development = 79 (orthic Granular Soil – slow permeability C soil)

Rainfall – 2-year 24 hour rainfall = 61.5 mm

10-year 24 hour rainfall = 94.2 mm

Pre-development 2-year peak discharge = 0.004 m³/s

Pre-development 10-year peak discharge = 0.01 m³/s

These values are not used in sizing of filter strips but they are important when peak flow control is required. Where required, retention or detention will be necessary, which will involve a device, or devices, to achieve peak flow control or extended detention.

The only runoff entering the filter strip originates from an impervious roadway of 1,800 m². The initial pervious abstraction is 3.4 mm, which results in a retention volume of 6.1 m³ for the roadway draining to the filter strip. The only flow through the roadway is along the kerb and the time of concentration to be used is the minimum T_c specified in the hydrology guidelines is 0.1 hours.

Post-development discharges

Post-development discharges must include a climate change factor.

Pre-development rainfall – 2-year 24 hour rainfall = 61.9 mm

Pre-development rainfall – 10-year 24 hour rainfall = 92.7 mm

Adjustment factor for 2-year rainfall = $2.1 \times 0.043 \times 61.9 = 67.1$ mm

Adjustment factor for 10-year rainfall = $2.1 \times 0.063 \times 92.7 = 106.7$ mm

$Q_{wq} = 0.006$ m³/s – with retention of I_a volume use I_a post-development as 3.4 mm.

$Q_{10} = 0.03$ m³/s

Filter strip design

1. $Q = AR^{0.67}s^{0.5}/n$

Where

Q = Water quality discharge (0.006 m³/s)
 A = Area of filter strip = (w , width in m) x (depth of flow, d , in metres)
 R = 0.05 m based on water quality storm and very wide flow path
 s = 0.03
 n = 0.35

- The width is given based on site conditions (75 m) so solve for y and ensure that it is less than 0.05 m.

$$d = (Qn/ws^{.5})^{.6}$$

You will know “ w ” based on local site conditions. For this example, assume $w = 75$ metres.

$$d = (0.006 (0.35) / 75 (0.03)^{0.5})^{.6}$$

$d = 5.3$ mm which is well under the maximum of 50 mm.

- Calculate the flow velocity

$V = Q/wd = 0.006 / 75 (0.005) = 0.016$ m/s which is well under the maximum 0.4 m/s allowed.

- Calculate the length of the filter strip.

$$L = Vt = 0.016 (540) = 8.6$$
 metres in length.

As can be seen from this example, the filter strip width can be reduced substantially to adjust to site conditions. The two key elements are a maximum depth of flow during the water quality storm of 22.4 mm and a residence time of at least 9 minutes (540 seconds) to establish the length of the filter strip.

In terms of a 2 or 10-year storm, the main concern is that velocities of flow not exceed 1.5 m/s. Going through an analysis of the 10-year storm (worst case scenario)

$$Q_{10} = 0.03 \text{ m}^3/\text{s}$$

Again using Manning’s equation:

$Q = AR^{0.67}s^{0.5}/n$ and solve for ‘ d ’ through the equation:

$$d = (Qn/ws^{.5})^{.6}$$

As the depth of flow still does not exceed the grass height the same n factor will be used. If the width of the filter strip were smaller and the depth of flow would exceed the design grass height an appropriate roughness coefficient to be used would be $n = 0.15$

$$d = (0.03 (0.35) / 75 (0.03)^{0.5})^{.6}$$

$$d = 14 \text{ mm}$$

Using the value to ensure that the velocity of flow during a 10-year storm will not exceed 1.5 m/s

$$V = Q/wd = 0.03 / 75 (0.014)$$

$V = 0.03$ m/s which is well under an erosive velocity.

The width of the filter strip could be reduced significantly if site conditions require.

8.5.3 Sand filters



<p>Description: Sand filters are designed and constructed to capture and treat stormwater runoff through:</p> <ul style="list-style-type: none"> • Sedimentation • Filtration • Volatilisation • Adsorption, and • Biological processes 	<table border="0"> <tr> <td colspan="2" data-bbox="788 707 1177 734">Stormwater Management Function</td> </tr> <tr> <td data-bbox="791 779 858 837"><input checked="" type="checkbox"/></td> <td data-bbox="967 770 1145 882"> Water quality <input checked="" type="checkbox"/> Metals <input checked="" type="checkbox"/> Sediment <input checked="" type="checkbox"/> TPH </td> </tr> <tr> <td data-bbox="791 913 858 972"><input type="checkbox"/></td> <td data-bbox="967 940 1145 967">Flood protection</td> </tr> <tr> <td data-bbox="791 1003 858 1061"><input type="checkbox"/></td> <td data-bbox="967 994 1168 1048">Stream channel erosion protection</td> </tr> </table>	Stormwater Management Function		<input checked="" type="checkbox"/>	Water quality <input checked="" type="checkbox"/> Metals <input checked="" type="checkbox"/> Sediment <input checked="" type="checkbox"/> TPH	<input type="checkbox"/>	Flood protection	<input type="checkbox"/>	Stream channel erosion protection
Stormwater Management Function									
<input checked="" type="checkbox"/>	Water quality <input checked="" type="checkbox"/> Metals <input checked="" type="checkbox"/> Sediment <input checked="" type="checkbox"/> TPH								
<input type="checkbox"/>	Flood protection								
<input type="checkbox"/>	Stream channel erosion protection								

Sand filters are holding tanks that collect and filter stormwater runoff before it discharges to the receiving environment. They slow the rate of stormwater entering the downstream system as well as removing some contaminants. Sand filters are similar to bioretention devices in that stormwater passes through a filtering media such as sand, gravel, compost or peat to filter out contaminants, however they do not have vegetation on the surface of the media. They are especially suited for small catchment areas and are primarily water quality treatment devices having little water quantity benefit. Their most appropriate use is on commercial and industrial sites.

Sand filters have been used to treat stormwater runoff for years, mainly because of sand filter effectiveness at removal of hydrocarbons. They are very suitable in ultra-urban environments where space is limited but are also used where more space is available in a similar fashion to ponds.

As they are so effective at removal of finer sediments, they are prone to clogging and require maintenance on a more frequent basis than a device such as wetlands. They are primarily used for high percentages of impervious surfaces where the majority of sediments are in the coarse fraction.

8.5.3.1 Basic design parameters

Sand filters should have a forebay (or sedimentation chamber) where coarser sediments would be captured and a filtration chamber, having an underdrain, for removal of finer sediments and hydrocarbons. A major component of a sand filter is live storage above the sediment/filtration chambers for storage of stormwater until the water can soak through the sand.

The following schematics provide a visual indication of how sand filters can be designed. They can be constructed similarly to ponds as shown in Figure 8-5, or an underground vault as shown in Figure 8-6 or as a linear filter as shown in Figure 8-7.

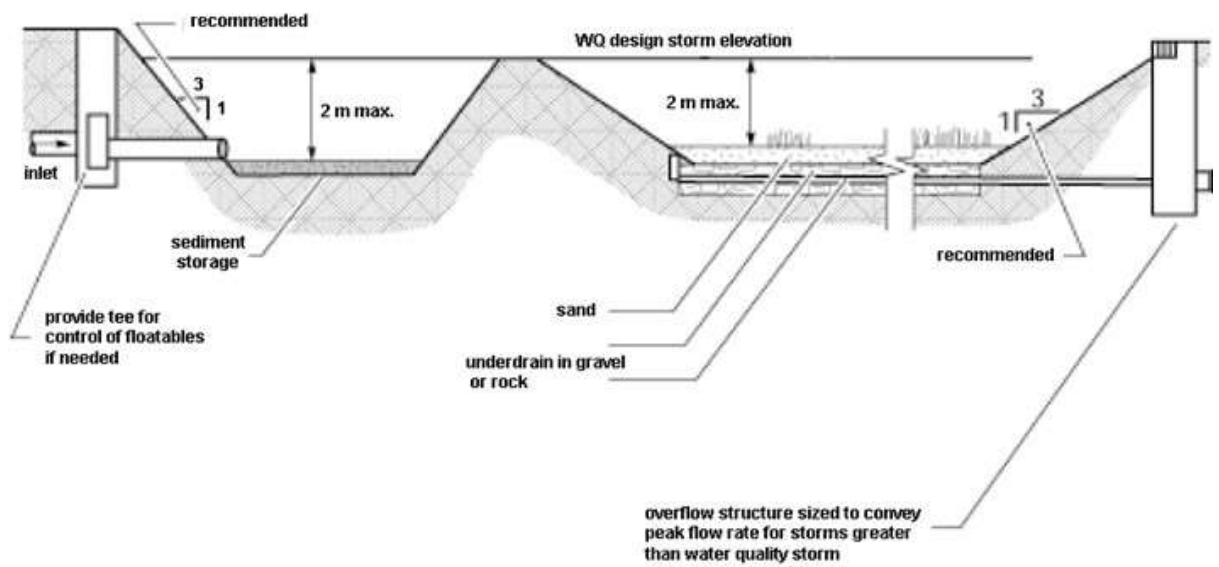

Figure 8-5: Sand filter basin¹⁰²

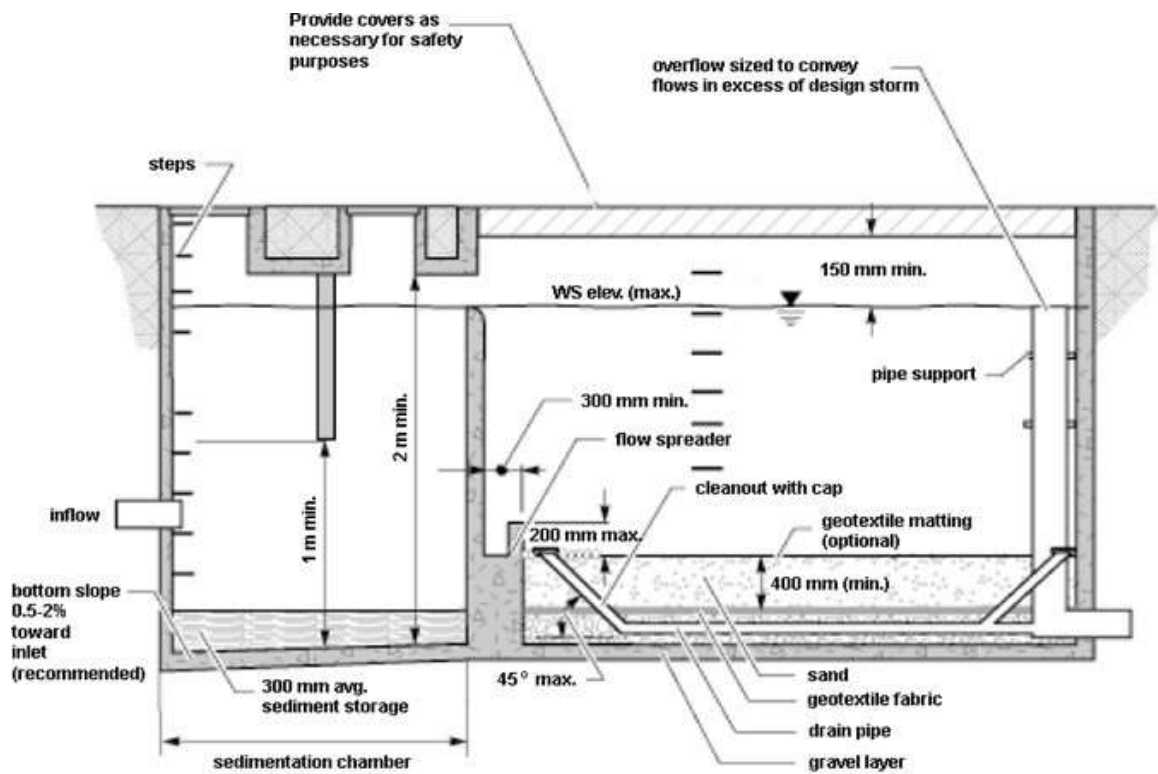

Figure 8-6: Vault sand filter¹⁰²

¹⁰² Auckland Regional Council, 2003

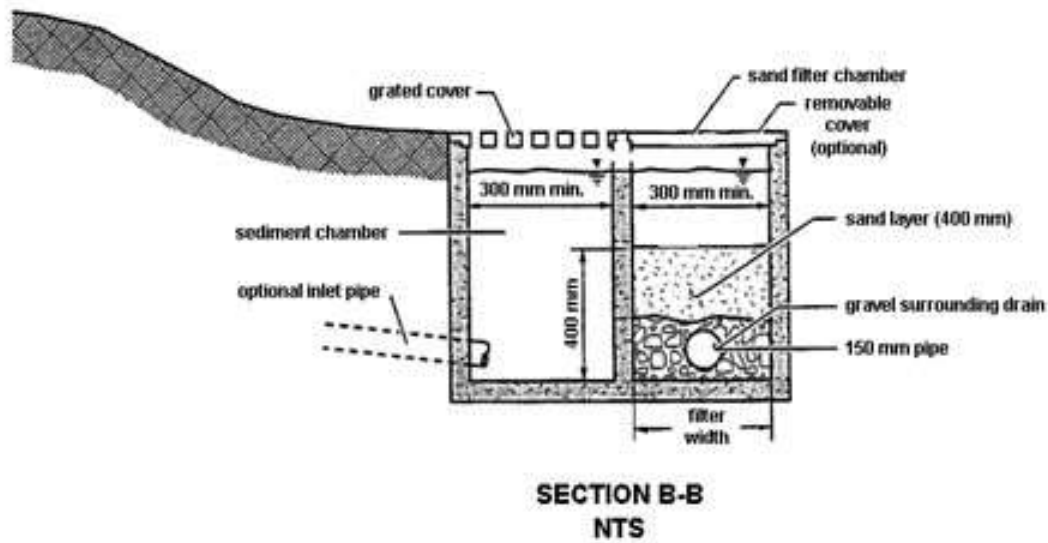
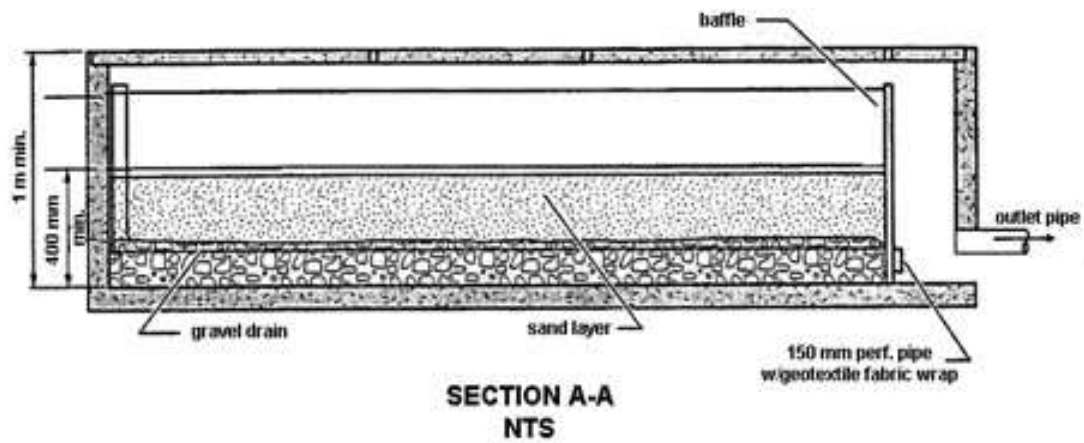
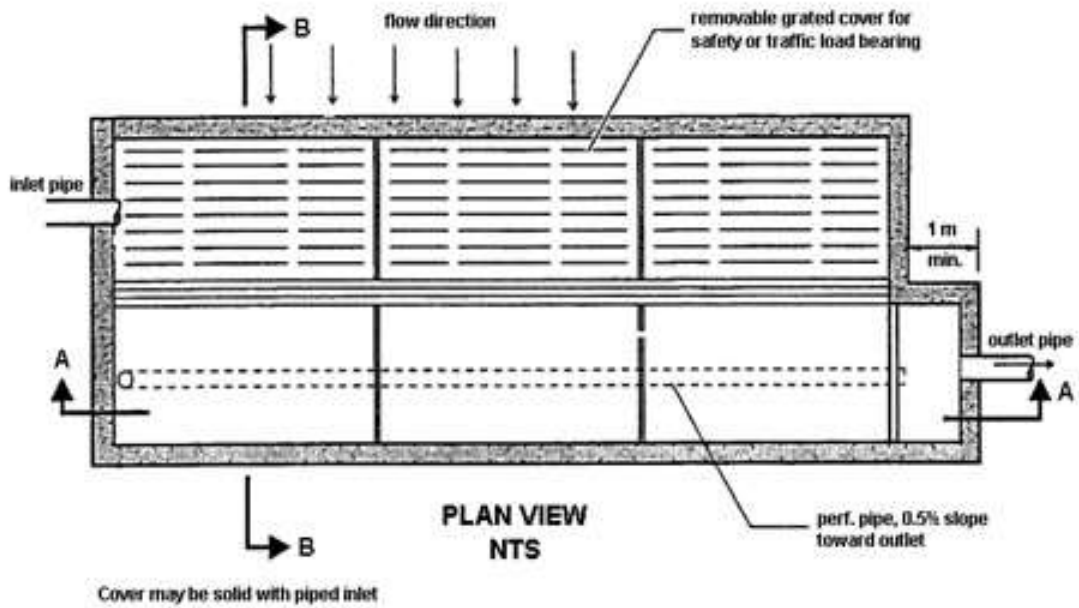

Figure 8-7: Linear sand filter¹⁰²

The treatment process is the same for all three of the devices, but Figure 8-5 allows for peak flow control in addition to water quality treatment. The other two figures provide water quality control only.

An important consideration of sand filter performance is the diversion of larger flows around the filter. Having high flows enter the filter with an overflow in the filter will significantly reduce performance, as turbulent flow will allow for finer sediments to pass over the filter bed. In a similar fashion, hydrocarbons having a specific gravity less than water will pass over the filter into the overflow pipe.

As sand filters generally have flow enter the filter in a concentrated flow conveyance a simple way to prevent contaminants from exiting the filter is to have a flow diversion structure placed prior to the sand filter. This is a simple design, especially when the flow into the filter is through a pipe.

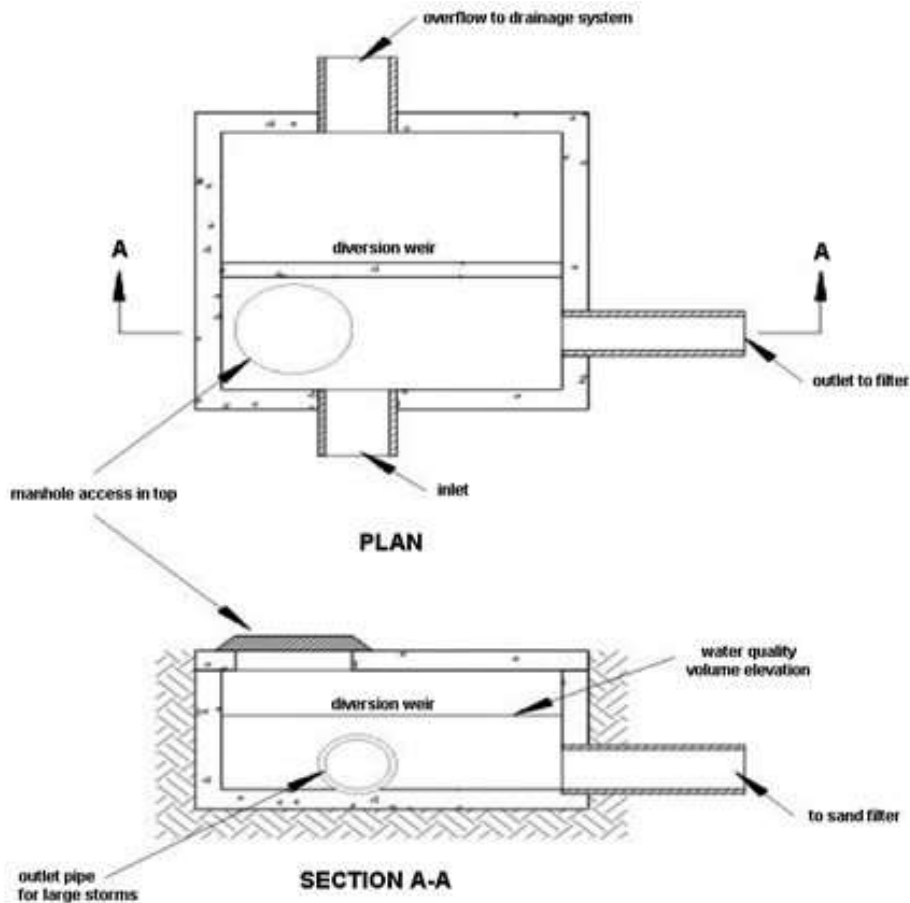

Figure 8-8: Diversion weir¹⁰²

Figure 8-8 provides a schematic of how the flow diverter can be designed so that the water quality storm passes through the sand filter and larger flows bypass it.

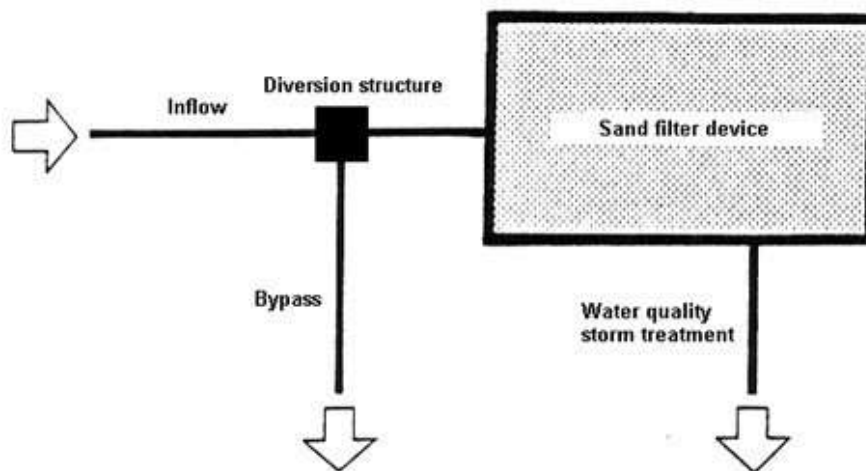

Figure 8-9: Large flow bypass schematic¹⁰²

Figure 8-9 shows a schematic of how the system is arranged.

Most street and road particulate matter is in coarser fractions. However, most stormwater contaminants are associated with fine particles. As sand filters have two chambers, the sedimentation chamber will remove the coarse sands and gravels while the filtration chamber will remove the finer silts and clays.

Similarly to bioretention, use of sand filtration is considered to meet the recommended retention of the initial abstraction due to the device being designed to drain over a 24-hour period. This effectively separates the discharge from the sand filter from the catchment discharge. These devices are considered to meet the recommended retention of the initial abstraction volume as their design discharge is based on a 24-hour discharge, which separates the device discharge significantly from the storm discharge. In addition, these practices are promoted due to their water quality benefits. A wet pond designed to discharge over 24 hours will not provide an equivalent level of treatment.

8.5.3.2 Detailed design procedure

Design approach:

Calculate the water quality volume to be treated. Using a sand filter meets the objective of retaining at least the initial abstraction volume. Having a time to drain of 1 day effectively separates the discharge from the sand filter from the catchment discharge.

1. A minimum of 37% of the water quality volume must be available as live storage to ensure that the water quality volume passes through the filter without bypassing.
2. The sand filtration chamber is sized by a variation of Darcy's Law.

$$A_f = V_{wq} d_f / k(h + d_f) t_f$$

Where:

- A_f = surface area of sand bed (m²)
- V_{wq} = water quality volume
- d_f = sand bed depth (m)
- k = coefficient of permeability for sand (metres/day)
- h = average depth of water (WQ storm) above surface of sand (m) (1/2 max. depth)
- t_f = time required for runoff to pass through the filter (days)

The following values should be used.

$$t_f = 1 \text{ day (maximum)}$$

$k = 1$ metre/day
 $d_f = 0.3$ metres (minimum)

Several points should be discussed regarding the values that should be used:

- Time required to pass the water quality storm
- The permeability rate selected

Time required passing the water quality storm

There are several reasons why this value was selected, as follows:

1. Having two days as a limiting value will ensure that the volume is available for the next storm. It should be recognised that these are averages and some fluctuation will occur.
2. Having the system drain within one day will prevent the development of biofilms on the surface of the sand, which would reduce permeability rates.

Permeability rate

This is an issue that has controversy associated with it. Sand has a high permeability rate (refer to Table 6-4 for permeability rates) and the value selected is very low. Experience has shown that the initial high permeability rate rapidly reduces when contaminated stormwater runoff passes through the sand. The rate reduces to a level where it stabilises for a period of time before complete clogging occurs. The value generally accepted internationally is approximately one metre/day.

1. Size the sedimentation chamber with the following points in mind.
 - a) Inflow into the chamber must not cause resuspension of previously deposited sediments
 - b) The sedimentation chamber outlet must deliver flow to the filtration chamber as sheet flow
 - c) The sedimentation chamber must be at least 25% of the filtration area
 - d) Flow velocities in the sedimentation chamber are required to be below 0.25 m/s
 - e) The sedimentation chamber must have a permanent pool with a minimum depth of 400 mm to reduce potential for sediment resuspension
 - f) The sedimentation chamber should be configured to avoid short-circuiting of flow.
2. The sand specifications are provided in Table 8-5.

Table 8-5: Sand specification

Sieve size (mm)	Percentage passing
9.5	100
6.3	95-100
3.17	80-100
1.5	50-85
0.8	25-60
0.5	10-30
0.25	2-10

There will be some variation in sand grades from the specified grades. However, a number are close to the lower limit and can be used. It is important to meet as closely as possible the specified limits as coarser aggregate will allow for more contamination migration and finer aggregate will clog more quickly.

Recent work undertaken by the Facility for Advancing Water Biofiltration in Australia has indicated excellent TSS and metals removal with soil and sand-based filters that are non-vegetated¹⁰³. Thus, it can be recommended that contaminants of greatest concern in Hamilton City (sediment and metals) could be effectively removed from stormwater discharges using sand filtration. A key element in the conclusion is that wetting and drying are key elements in treatment.

3. An under-drainage system shall be provided. The system will normally consist of perforated lateral pipes (150 mm diameter) that are placed in the gravel or stone layer that is under the sand. The depth of the gravel layer shall be at least 200 mm in depth with filter fabric between the gravel and sand to prevent migration out of the system.

8.5.3.3 Case study – Sand filter

Project description

It is the intention to construct a parking lot having a surface area of approximately 2,000 square metres in Whangamata and the site has a 4% slope.

Hydrology

1. The 2-year 24 hour storm is 120 mm so the water quality storm should be 40 mm of rainfall. However for design purposes a design water quality storm of 30mm can be used (refer to Section 7.3.3).
2. Due to the site discharge being located in a tidal area there is no requirement to retain the initial abstraction volume or to do peak flow control.
3. Calculate the water quality volume to be treated using the Waikato Stormwater Runoff Modelling Guideline.

$$V_{wq} = 51 \text{ m}^3$$

Sand filter design

1. Live volume of storage needed $V_{live} = .37(51\text{m}^3) = 18.9 \text{ m}^3$
2. Sand filter surface Area - Assume that max. head, $h_p = 1$ metre so $h = 0.5$ m

$$A_f = V_{wq}d_f/k(h+d_f)t_f$$

We know the following:

$$V_{wq} = 51 \text{ m}^3$$

$$d_f = 0.3 \text{ m}$$

$$k = 1 \text{ m/day}$$

$$h = 0.5 \text{ m}$$

$$t_f = 1 \text{ day}$$

$$A_f = (51) (0.3) / 1 (0.5 + 0.3) 1$$

$$A_f = 19.1 \text{ m}^2$$

3. Size sedimentation chamber has to have at least 25% of the surface area of the filter area = 4.8 m^2 . As the surface area is 19.1 m^2 , it meets the live storage requirement of 1.9 m^2 .

¹⁰³ Facility for Advancing Water Biofiltration, 2008

8.5.4 Bioretention



<p>Description: Bioretention devices are designed and constructed to capture and treat stormwater runoff through:</p> <ul style="list-style-type: none"> • Sedimentation • Filtration • Infiltration (depending on soils) • Adsorption, and • Biological processes 	<p>Stormwater Management Function</p> <table> <tr> <td data-bbox="869 779 938 853" style="text-align: center;">✓</td> <td data-bbox="1042 730 1230 920"> <p>Water quality</p> <ul style="list-style-type: none"> ✓ Metals ✓ Sediment ✓ TPH ~ Nutrients ~ possibly through specific design </td> </tr> <tr> <td data-bbox="869 943 938 1016" style="text-align: center;">x</td> <td data-bbox="1042 972 1222 999">Flood protection</td> </tr> <tr> <td data-bbox="869 1055 938 1128" style="text-align: center;">✓</td> <td data-bbox="1042 1055 1243 1106">Stream channel erosion protection</td> </tr> </table>	✓	<p>Water quality</p> <ul style="list-style-type: none"> ✓ Metals ✓ Sediment ✓ TPH ~ Nutrients ~ possibly through specific design 	x	Flood protection	✓	Stream channel erosion protection
✓	<p>Water quality</p> <ul style="list-style-type: none"> ✓ Metals ✓ Sediment ✓ TPH ~ Nutrients ~ possibly through specific design 						
x	Flood protection						
✓	Stream channel erosion protection						

Bioretention is a common term that is used internationally to describe the storage, passage and eventual discharge of stormwater to a receiving system.

Bioretention is a description of a process whereby stormwater runoff is treated by passing the water through a soil media and then either the water evapotranspires, or the water infiltrates into the ground or providing a very slow release to surface waters when infiltration to ground cannot be achieved.

Bioretention operates by filtering stormwater runoff through a soil media prior to discharge into either the ground or a drainage system. The major pollutant removal pathways within bioretention devices are¹⁰⁴:

- Event processes
 - Sedimentation in the extended detention storage, primary sediments and metals
 - Filtration by the filter media, fine sediments and colloidal particles; and
 - Nutrient uptake by biofilms
- Inter-event processes
 - Nutrient adsorption and pollutant decomposition by soil bacteria; and
 - Adsorption of metals and nutrients by filter particles.

To retain the filter media within the bioretention device and aid drainage, one or more layers are used at the bottom of the filter. The surfaces of most bioretention devices are planted with

¹⁰⁴ Somes and Crosby, 2008

a range of vegetation. Figure 8-10 shows a schematic of a bioretention device highlighting key elements and flow paths.

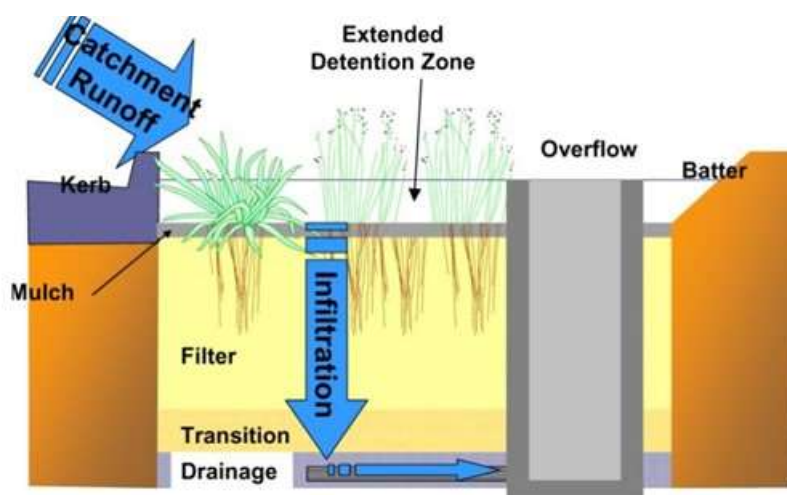

Figure 8-10: Schematic of bioretention device key elements and flow paths¹⁰⁵

8.5.4.1 Use in a treatment train¹⁰⁶

Bioretention devices can be used in different locations in a catchment (at-source through to lower catchment) to provide stormwater treatment, retention and to a lesser extent peak flow control. Benefits of bioretention include:

- Water quality treatment through sedimentation, filtration (physical filtration and biofiltration)
- Reduction in peak flows by slowing down the runoff
- Reduction in runoff volumes through infiltration and evapotranspiration
- Provides groundwater recharge through infiltration
- Reduces thermal effects
- Biological uptake; both plants and microbes
- Provides ecological, cultural and aesthetic values

8.5.4.2 Bioretention variations¹⁰⁷

Bioretention devices can be provided in a variety of forms including the following:

- Raingarden
- Planter box
- Tree pit, and
- A swale modification to incorporate bioretention.

Raingarden

Raingardens are planted garden beds containing specified soil media that promote filtering and retention. In most situations, raingardens are directly connected to impervious surfaces, although sometimes there is an intermediary filter strip or rock apron to reduce scouring or to capture entrained sediment. In some situations, where it is not possible to directly connect the raingarden to the impervious area, stormwater may be piped into the raingarden.

¹⁰⁵ City of Kingston, Melbourne, Australia

¹⁰⁶ Auckland Council, December 2017

¹⁰⁷ North Shore City Council, July 2008

As stormwater enters the raingarden it is filtered through plants specifically selected to tolerate wet and dry conditions and to provide water quality treatment. The stormwater then receives additional treatment as it permeates through an organic mulch layer, then root zone of the plants, and through a sequence of soil layers. These soil layers are organic in the top layers, such as sandy loam enriched with compost, followed by porous sandy soil, to a gravel drain with a transition layer. Treated water in the gravel layer is then infiltrated or collected via perforated pipes. These pipes flow to an approved outlet to enter the receiving environment or reticulated systems.

A schematic of a typical cross section of a raingarden is shown in Figure 8-11 below.

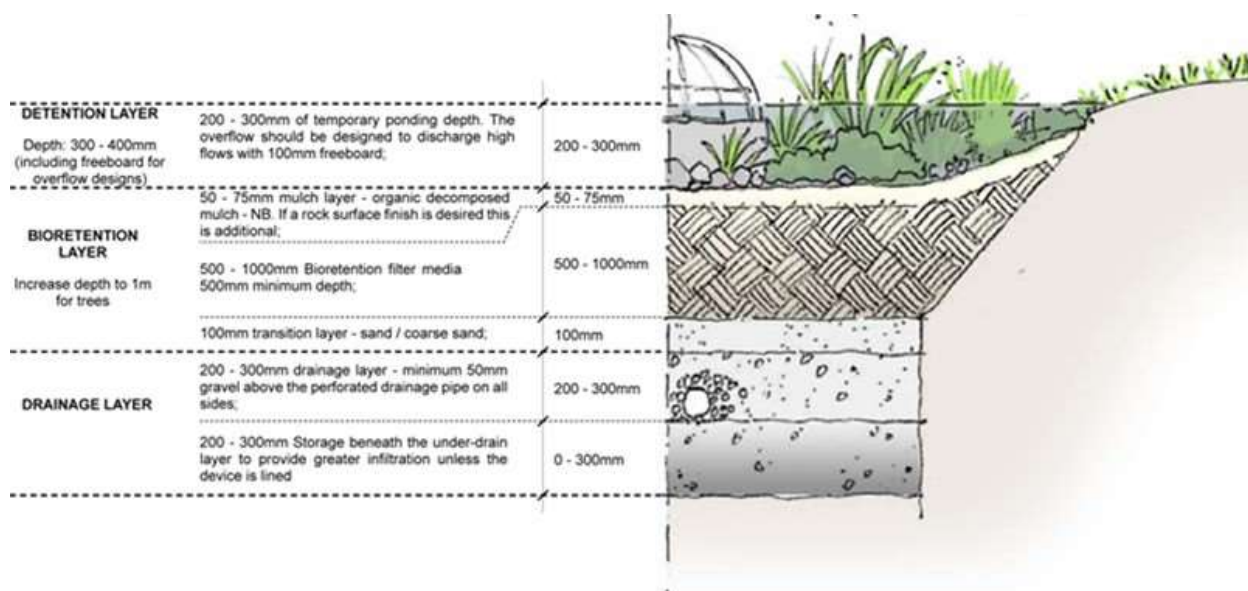

Figure 8-11: Schematic of a rain garden cross section¹⁰⁷

As well as filtering and infiltrating stormwater, raingardens also provide temporary ponding on their surface. Storm events that are greater than the design storm, overflow from the raingarden will often flow into a grated overflow and connect to the reticulated system as the base of the raingarden. Alternatively, excess stormwater may overflow to an overflow path or a sequence of stormwater management devices in a treatment train. The overflow should normally ensure that higher storm flows bypass the rain garden. A common way that this is done is ensuring the entrance to the rain garden is where the bypass occurs. The rain garden, having no designed outlet, will cause stormwater flow to pond on its surface. This ponding will prevent additional flows from traveling through the rain garden and resuspending contaminants or causing contaminants still in suspension to travel through the rain garden to a catch pit. If flow diversion at the inlet is not possible then the overflow should be positioned away from the inlet to avoid short circuiting. Ensure the bioretention device is horizontal to encourage uniform flow over the full surface area of the raingarden.

Planter box

Planter boxes are smaller versions of raingardens often used in an above-ground pre-cast concrete unit, with specific soil media in which plants are grown. Planter boxes are ideally suited to accept roof runoff. Stormwater planter boxes operate as follows:

- Runoff is discharged into the planter from a downpipe, this can either be via surface discharge or a bubble up inlet.
- The 'first-flush' of stormwater infiltrates soil layers and is collected in a drainage layer to be directed to a discharge point.
- Ponding occurs as soils become saturated to the top of wall level in the planter box. An outlet riser comes into operation when the ponding capacity is full. Excess runoff is discharged through the outlet riser and standpipe to the reticulated system.

If planter boxes are adjacent to buildings they should be above ground. Stormwater planters can be partially sunk, but advice from a geotechnical engineer is required if they are within 3m of a building's foundation.

The device should have a horizontal surface. Stormwater planters are generally lined with impervious geotextile to protect adjacent structures and reduce infiltration. Because they receive roof runoff, maintenance is generally less frequent than for raingardens and tree pits receiving road runoff.

The minimum size for a planter box should be 2m².

Figure 8-12 shows a schematic of a planter box cross-section.

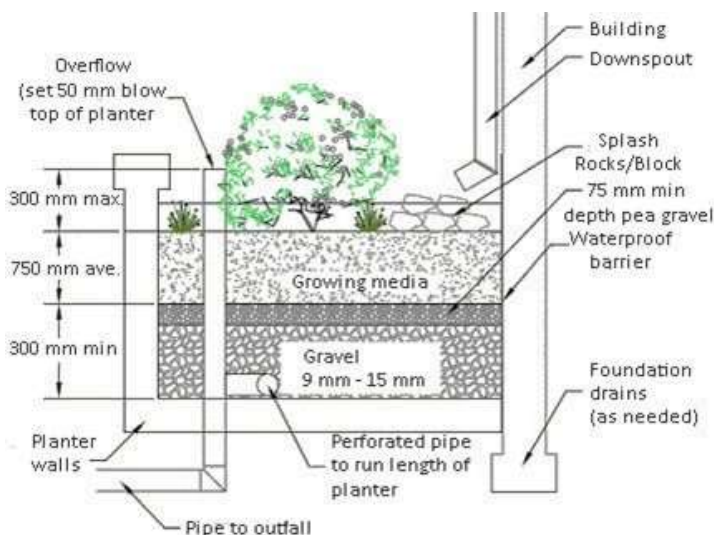

Figure 8-12: Schematic of a planter box cross section¹⁰⁸

Stormwater tree pit

A stormwater tree pit (as opposed to a street tree pit) is another variation of a bioretention device designed for trees. They can provide better retention than raingardens because of high evapotranspiration associated with large trees. They require the same components as a raingarden but they normally require greater depth of media to account for the tree's root ball and future root growth.

The designer must have an understanding of the maximum root ball size at the tree's maturity and accommodate the tree's future needs, including the need for additional / replacement soil without removal of the tree, and increased irrigation needs during establishment. These requirements can limit the use of a tree pit where there are other services competing for space.

Stormwater tree pits are especially beneficial as they shade adjacent impervious surfaces and reduce thermal effects to receiving waters. They also provide ecological and aesthetic values to the roading corridor.

A schematic of a tree pit cross-section is shown in Figure 8-13.

¹⁰⁸ Internet download and modified

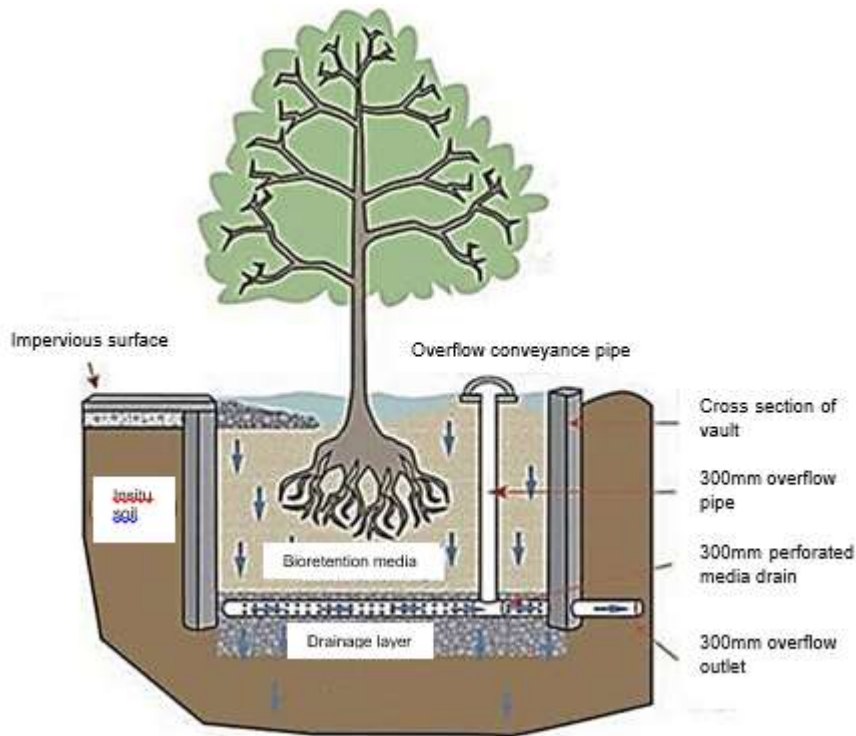

Figure 8-13: Schematic of a planter box cross section¹⁰⁸

Bioretention Swale

Swales can be modified to incorporate bioretention components and to improve detention and water quality treatment.

Flow needs to be uniformly distributed over the full surface area of the filter media to achieve maximum pollutant removal. Swale design should incorporate a flow-spreading device at the inlet such as a shallow weir across the channel bottom or a stilling basin.

When the bioretention trench is located along the full length of the swale base, the desirable maximum longitudinal grade is 4%. To ensure stormwater has sufficient time to filter into the bioretention layers, check dams should be used along the swale length.

A common way to design bioretention swales is to use a system of discrete cells, with each cell having an overflow pit that discharges to the piped stormwater system. Bioretention systems can then be designed upstream of the overflow, thus allowing for a depth of ponding over the bioretention media.

The type of vegetation depends on landscaping needs but the denser the vegetation the greater the filtration achieved. Use of native vegetation (native grasses, tussocks and sedges) can reduce mowing and maintenance needs.

A schematic of a bioretention swale is shown in Figure 8-14.

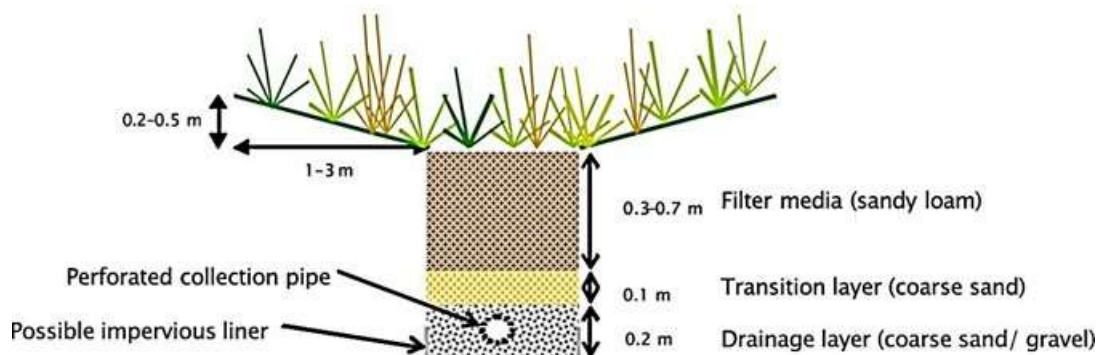

Figure 8-14: Schematic of a bioretention swale cross section¹⁰⁸

Bioretention swale for pumice soils

If there are pumice soils with high permeability a bioretention swale can be used to treat runoff before infiltration of runoff to ground. This can be used in the roading corridor next to roads to treat road runoff, or can be used as part of a treatment train prior to a flow attenuation/infiltration device.

If adjacent to a road, an underdrain may be required to ensure the road's basecourse isn't impacted by the infiltration of runoff.

If groundwater levels are high or there are geotechnical concerns, an impervious liner is recommended at the base and sides of the bioretention swale (beneath the drainage layer) plus the underdrain would be required. A geotechnical practitioner should be involved to advise whether this is a requirement.

The bioretention swale would be sized for the water quality event, with larger flows bypassing the device.

8.5.4.3 Basic design parameters

The main components of a bioretention device includes the following:

Table 8-6: Main components of a bioretention device¹⁰⁶

Component	Description
Grass filter strip	For minor pre-treatment (where space is available)
Ponding area	The ponding area is designed to provide temporary runoff storage. Plants within this area must be tolerant to wet and dry conditions.
Mulch layer	The mulch protects the plants and soils from drying and weed growth.
Media	The filter media is more commonly engineered soils unless in situ soils have been tested and approved for a given application.
Transition layer	The transition layer prevents media migrating into the drainage aggregate. It generally comprises media of a certain particle size, smaller in diameter than the drainage aggregate.
Drainage layer	The drainage aggregate is larger gravels (such as pea gravel).
Underdrain system (where infiltration is not intended)	Treated water is conveyed to the underdrain from the drainage layer and from there into the conveyance system.
Storage (retention) layer	The storage layer is provided to retain stormwater from small storms in the bioretention device to allow for percolation (retention) between storm events. The storage layer can be designed so that stored water is available to vegetation to reduce the need for irrigation in dry periods.
Plants	Plants provide key functions including maintaining infiltration rates through root growth and die back, providing carbon sources in filter media, and providing surfaces for biofilm development on roots. They must be carefully selected to ensure optimum function.
Structural support	Where bioretention devices are required to be close to structures, or to trafficked roads, structural support may be required.

From an inflow perspective, it is important that flows do not cause scour at the inlet of the device. This can be undertaken easily if flow entry is dispersed but concentrated flow will require armouring to ensure stability.

Depending on the natural soils in the area that the bioretention device has been placed, final discharge of stormwater can be to ground or through a drainage system to surface waters. This will depend on the permeability rates of the underlying soil, depth to groundwater or bedrock and the stability of any slopes that the additional water may be discharged within. In the situation where the eventual disposal of stormwater is to ground, testing of infiltration rates needs to be undertaken consistent with infiltration devices discussed in the next subsection.

It is not recommended that geotextile filter cloth be used between the different media layers in the bioretention devices, as that will become a point of clogging in the filter. Proper installation of the various layers of media (including the drainage layer) will reduce potential migration of contaminants to the drainage system.

Bioretention devices are designed as water quality devices and will generally not be used for water quantity control. If peak flow control is required and cannot otherwise be provided then consideration should be given to providing a constructed wetland that also provides peak flow control instead of a bioretention device.

Bioretention devices are considered to meet the requirement to retain the initial abstraction volume for the contributing catchment area draining to the device. This is because bioretention devices delay the peak flows and retention is achieved through evapotranspiration and infiltration.

If a bioretention device can be sized for 1 or 1.2 times the water quality volume (depending on whether there is evidence of existing stream erosion), and meets the live storage requirement for bioretention devices, then it is also considered to provide extended detention for the contributing catchment area.

8.5.4.4 Bioretention device with a saturated zone

Where nutrient reduction is required, a conventional bioretention device can be modified to provide a saturated zone to provide nitrogen removal.

Figure 8-15 below shows a bioretention device designed with a submerged / saturated zone for nitrogen removal. Providing a saturated zone will avoid nitrogen spikes following dry periods.

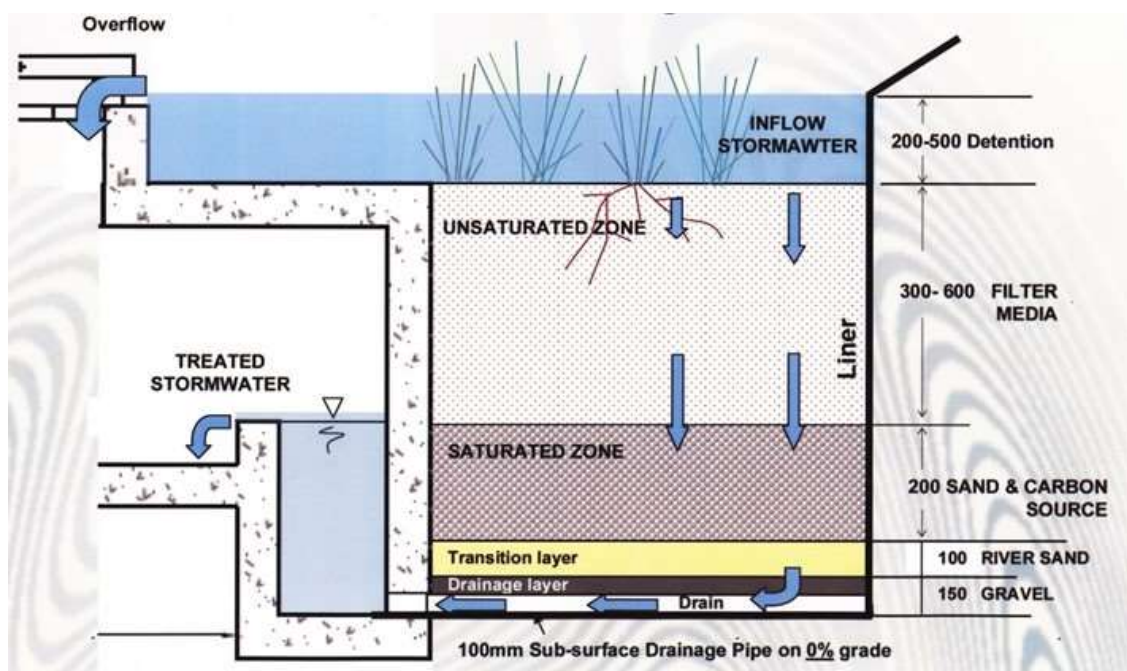

Figure 8-15: Bioretention device with a submerged zone¹⁰⁹

¹⁰⁹ Facility for Advancing Biofiltration, 2008

8.5.4.5 Design considerations

Table 8-7 below summarises the site considerations when designing a bioretention device.

Table 8-7: Site design considerations for bioretention devices

Site consideration	Discussion
Catchment area	Maximum catchment area per bioretention device is 2 hectares
Location	<p>Bioretention devices:</p> <ul style="list-style-type: none"> • Should be located so stormwater can flow to the device under gravity. • Shouldn't be located within a floodplain or overland flowpaths. • Should be located to minimise the pervious area draining to them. • Should be located away from unstable slopes.
Slope	<p>While not prevented from use, placement of bioretention on steep slopes will be limited by the need to have a level surface over the bioretention device to ensure even flow through the media.</p> <p>Bioretention devices must be lined with an impermeable membrane for sites that are part of an overall sloping site.</p> <p>A bioretention device may only be used on slopes steeper than 14° (25%) if the effects have been assessed by a geotechnical engineer.</p> <p>The device must be placed more than 15m away from slopes of 9° (15%) or more.¹⁰⁸</p>
Subsoils	<p>Bioretention can be used in any soil, but eventual discharge to ground has the same limitations as for infiltration devices.</p> <p>It is important to protect subsoils from compaction during construction.</p>
Groundwater	<p>Having seasonal groundwater levels approaching the invert of the device can cause groundwater mounding that may adversely impact on the ability of the device to drain. This could cause bypass of stormwater flows when design capacity is reduced. Seasonal high water tables should be no less than 1 metre from the invert of the device.</p>
Stormwater overflow	<p>When flows exceed the volume capability of the bioretention device, the overflow discharge shall go to a designed outfall point that is protected from potential scour.</p>
Setback ¹¹⁰	<p>Devices shall be 1 m minimum from property boundaries.</p> <p>They must not be placed within the zone of influence of foundations or within 3 m of the edge of any structure with the exception of stormwater planters, which are designed to abut buildings.</p> <p>If a bioretention device is installed upslope and within 6m of a structure, it should be lined to prevent potential saturation of the foundation soils. This recommendation can be reduced on the advice of a geotechnical engineer.</p>
Roads	<p>Bioretention devices installed adjacent to roads should have an impermeable lining adjacent to the road to prevent stormwater migrating to the road sub-grade.</p> <p>A concrete edge beam or wall should be used to provide support on the side adjacent to the road.</p>
Contaminated land	<p>Bioretention devices must be fully lined with an impervious liner if contaminated land is present</p>

Table 8-8 below provides design considerations for designing bioretention devices.

Table 8-8: Design considerations for bioretention devices¹⁰⁶

Minimum size	Minimum size for a bioretention device is 2m ²
Ponding area	The ponding area should drain all pooled water within 24 hours
Pre-treatment	Required for bioretention devices > 50m ² or where high contaminant loads are anticipated.
Inlet design	Good inlet design is essential. Flows should be directed into the device as sheet flow over a vegetated filter strip if possible. Flows into the device should avoid concentrated flow and scour. Highflows should bypass the device.
Ponding depth	At least 200-300 mm
Vegetation	Appropriate vegetation must be selected for bioretention devices. Plants should: ^{Error! Bookmark not defined.} <ul style="list-style-type: none"> • Be able to tolerate periods of inundation and longer dry periods • Be perennial • Have deep fibrous root systems • Have spreading rather than clumped growth forms, and • Be suited to free draining soils <p>Refer to Table 8-10 and Table 8-11 for listed plant species suitable for bioretention devices.</p> <p>Successful plant establishment can be achieved when the plants are robust and self-sustaining, and meet the following criteria:¹¹¹</p> <ul style="list-style-type: none"> • Vegetation must cover at least 90% of the device with mulch covering the remainder. • Average ground plant height >500mm • Plants must be healthy and free from disease, no weeds or litter to be present. • Planting will require supplementary watering immediately after planting and for the first 4 weeks minimum.
Media	The requirements for the bioretention media are outlined below: <ul style="list-style-type: none"> • Media depth to be at least 500mm • All media must be laid below the inlet • Mulch: 50 – 100mm non-floating mulch layer (that does not add contaminant load). To be 75% organic mulch and 25% compost mix. • Planting media: Minimum planting media depth is 500mm (and at least 1m depth for trees). Discussed in Section 8.5.4.6 below. • Transition layer: 100mm depth of clean well graded coarse sand with minimal fines. No geotextile to be used. • Drainage layer: 200mm minimum thickness of washed drainage gravel (2-5mm) with little / no fines. Graded at a minimum of 0.5% toward the outlet. Provide at least 50mm cover above the drainage pipe. • Retention storage / saturated zone: See below
Underdrain	Must be sized to fully drain the detention layer within 6-24 hours and be placed at gradient of at least 0.5%. Must be surrounded by a layer of clean, washed gravel.

¹¹¹ Hamilton City Council Three Waters Management Practice Note HCC04 Bioretention devices

	<p>Underdrains should be slotted rigid pipe (uPVC or similar to AS2439.1) with 2mm wide slots cut across the top third of the pipe at maximum 50mm centres. Minimum diameter:</p> <ul style="list-style-type: none"> • Up to 10m² bioretention device: 100mm dia • 10m² – 20m² bioretention device: 1 x 150mm or 2 x 100mm dia • >20m² bioretention device: specific design required. <p>One drain per 3m width of bioretention system. The pipe shall not be installed with a filter sock around it.</p> <p>Underdrains should be evenly spaced along the length of the device. They should be placed 75-300mm above the bottom of the drainage layer where no liner is present to allow for infiltration into the insitu soils, or on top of the liner if one is used. <small>Error! Bookmark not defined.</small></p>
Retention storage / saturated zone	<p>A saturated zone is recommended beneath the drainage layer to facilitate infiltration to the underlying natural soils and reduced discharge volumes.</p> <p>Use the same media as for the drainage layer but sits below underdrain invert. Must be at least 450mm deep and not have an impervious layer.</p>
Geotextiles	<p>Geotextile/filter cloth is NOT to be placed between any filter layers. Geotextile to be placed below drainage layer when constructed in clay soils.</p> <p>A variety of geotextiles can be used to line the excavation walls as liners and root barriers.</p> <p>In most cases it is not necessary to use concrete lining for bioretention devices. Exceptions to this are stormwater planters that are raised above ground level and concrete edging for devices adjacent to roads.</p> <p>Permeable liners must:</p> <ul style="list-style-type: none"> • Not extend onto the base of the excavation (except in clay soils where the drainage layer may migrate into the saturated clays). • Be pinned to the base soil and be covered with at least 200mm of media. • Be resistant to soil acidity and microbial degradation. <p>Impermeable liners may be used where the bioretention device is connected with a stormwater harvesting system, or site conditions require lining (eg unstable ground, steep slopes). Impermeable liners must:</p> <ul style="list-style-type: none"> • Have an infiltration rate of 1×10^{-9} m/s • Meet geotechnical requirements
Root barriers	<p>Should be used where there is potential for plant or tree roots to penetrate susceptible services or structures. Root barriers should only be placed adjacent to services/structure that requires protection. Trees will not survive if root barriers are used at the base of the device.</p>
Access	<p>Suitable access needs to be provided for routine maintenance. Small devices may require access for a wheel barrow, while larger devices will require access suitable for a small excavator.</p>

8.5.4.6 Detailed design procedure

Design approach:

1. Determine the water quality storage volume.
2. Minimum live storage provided above the soil media is 40% of the water quality volume to ensure that the entire water quality storm passes through the bioretention devices. Failure to provide the storage will result in system bypass and reduced water quality expectations.

3. Calculate the required surface area of the bioretention devices.

$$A_s = (WQV)(d)/k(h+d)t$$

Where:

A_s = surface area of bioretention devices (m^2)

WQV = water quality treatment volume (m^3)

d = planting soil depth (m)

k = coefficient of permeability (m/day)

h = average height of water (m) = $\frac{1}{2}$ maximum depth

t = time to pass WQV through soil bed

The following values should be used.

d = 0.85 metre minimum

k = 0.75 m/d

h = 0.15 m average depth (maximum water depth 300 mm)

t = 1 day

4. General comments on bioretention devices

- If less depth of media must be used due to local constrictions (bedrock, groundwater) the area of storage must be increased so the same volume of storage in the media is maintained. The simplest way to ensure the storage volume is maintained is the following ratio:

$$A_{rev.} = A_s/d_{rev.}$$

Where:

A_{rev} = Revised surface area resulting from decreased depth

A_s = Area of bioretention devices calculated in step 3 (m^2)

$d_{rev.}$ = Actual depth provided/0.85

- The coefficient of permeability will initially decline during the establishment phase, as the filter media settles and compacts, but this will level out and then start to increase as the plant community establishes itself and the rooting depth increases.
- Keep contributing catchment areas small and avoid sizing a bioretention device for too large a catchment area. It is better to have more frequent, smaller bioretention devices than fewer larger ones.
- Place bioretention devices in areas where they will not interfere with normal use of the property and where they don't interfere with sight lines, which may present safety issues.
- Where possible, design bioretention devices as off-line systems so that larger flows do not scour the surface of the bioretention devices.

5. Planting soil media

The main component of the bioretention device is the planting media. Bioretention device planting media must:

- Have sufficient available water, air and initial nutrients to support healthy plant cover.
- For raingardens, stormwater planters and tree pits the surface of the planting media should be flat and level to avoid localised ponding and blinding. For bioretention swales the surface should be gently sloping.
- Not generate contaminant and not shrink or collapse.
- Be protected from compaction and or resistant to compaction.

- Be sourced from a reputable supplier.

General media specifications for soils are provided in Table 8-9 below.

Table 8-9: Bioretention device planting media specification

Item	Specification
Saturated hydraulic conductivity ¹	150 – 300 mm/hr
Plant available water	100 mm
Organic matter	10 – 30% by volume
pH range	6.5 – 7.5+
Electrical conductivity	<2.5 ds/m
Total nitrogen	<1,000 mg/kg
Total phosphorus	Leachate testing required if > 100 mg/kg
Total copper	≤ 80 mg/kg
Total zinc	≤ 200 mg/kg
Planting media sources	From a clean source (no waste products)

Note:

¹ Hydraulic conductivity of potential filter media should be measured using the ASTM F1815-06 method

When constructing a bioretention device, the planting media is to be placed in 300-400mm layers and is to be wet to aid natural compaction. A light weight lawn roller can be used to compact the media. Media is not to be compacted using a digger bucket.

Pumice sand planting media

Planting media for bioretention devices can be purchased ready-made, or if pumice sand is readily available, there is an option to utilise pumice sand for the planting media. If utilising the latter, the media should comprise the following:

- 90% pumice sand with 10% organic matter

Work undertaken for Auckland Council¹¹² provided an analysis of various filter media and demonstrated that pumice sand with organic matter can be effective at contaminant capture while providing reasonable saturated hydraulic conductivity. Material should:

- Have an average bulk density of 0.505 g/cm³
- Pumice sand should be well graded.
- Pumice sand is brittle so compaction during installation must be avoided and water must be sprayed during installation to reduce potential particle crushing.
- The organic matter should be a blend of peat and sand with 70% peat, 30% sand. The organic matter should be dry when blended with the pumice prior to placement in the excavated area. Once blended, wetting should be undertaken as the media is placed as a substitute for light tamping.

The pumice sand should be well graded and the range of particle sizes appropriate for bioretention devices shall be between 0.1 mm – 2 mm in particle size whose uniformity value is above 8 (well mixed in sizes).

¹¹² Fassman et al, 2013

Raingarden providing treatment prior to infiltration



6. Transition and drainage layers

The transition layer and drainage layer are to be as per Table 8-8 above.

If pumice is the media of choice, the pumice can eliminate the need for a coarse sand layer but the depth of pumice should include the 100 mm additional depth that the transition layer would occupy.

If the soils under the bioretention device has high permeability, the underdrain can be eliminated and the device will function as an infiltration device with the filter media providing pre-treatment of runoff prior to infiltration.

7. Plant material

Plants are important for nitrogen and phosphorus removal. They extract these macro-nutrients when actively growing; decomposing leaves and roots gradually release these but at a rate that can be re-used by the plants¹¹².

Consider the following when making planting recommendations:

- Native plant species should be specified over exotic or foreign species
- Appropriate vegetation should be selected on its ability to thrive in wet and dry conditions.

The following tables provide some recommendations for plant species suitable for bioretention devices.

Table 8-10: Recommendations for trees and shrubs

Trees and shrubs	Descriptions
<i>Brachyglottis repanda</i> rangiora	Coastal shrub or small tree growing to 4m+. Large attractive pale green leaves with white fuzz on underside.
<i>Coprosma acerosa</i> sand coprosma	Grows naturally in sand dunes. Yellow, interlaced stems and fine golden foliage. Forms a tangled shrubby ground cover. Tolerates drought and full exposure. Prefers full sun.
<i>Coprosma robusta / C. lucida</i> karamu, shining karamu	Shrubs or small trees growing to 3m+, with glossy green leaves. Masses of orange-red fruit in autumn are attractive to birds. Hardy plants.
<i>Cordyline australis</i> ti kouka, cabbage tree	Palm-like in appearance with large heads of linear leaves and panicles of scented flowers. Sun to semi-shade. Prefers damp to moist soil. Grows eventually to 12m+ height.
<i>Cordyline banksii</i> ti ngahere, forest cabbage tree	Branching from the base and forming a clump. Long strap-shaped leaves with red-orange coloured veins. Prefers good drainage and semi-shade.
<i>Corokia buddleioides</i> korokio	Bushy shrub to 3m, with pale green leaves with silvery underside. Many small bright yellow starry flowers are produced in spring. Prefers an open situation but will tolerate very light shade.

Trees and shrubs	Descriptions
<i>Entelea arborescens</i> whau	Fast growing shrub or small tree (to 5m height) with large bright green heart-shaped leaves. Spiny seed capsules follow clusters of white flowers in spring. Handsome foliage plant
<i>Geniostoma rupestre</i> hangehange	Common forest shrub with pale green glossy foliage, growing to 2-3m. Tiny flowers give off strong scent in spring. Looks best in sunny position where it retains a bushy habit, and prefers well drained soil.
<i>Hebe stricta</i> koromiko	Shrub or small tree growing to 2-5m in height. Natural forms have white to bluish flowers. Many cultivars and hybrids available with other colours, but unsuitable for use near existing natural areas. Full sun.
<i>Leptospermum scoparium</i> manuka	Shrub or small tree growing to 4m+ in height. Natural forms have white to pinkish flowers. Many cultivars and hybrids available with other colours, but unsuitable for use near existing natural areas. Hardy and tolerant of difficult conditions.
<i>Metrosideros robusta</i> rata	Eventually forms a large tree. Flowers bright red in summer. Will tolerate dryness and exposure. Full sun.
<i>Pittosporum cornifolium</i> tawhirikaro	A slender branched shrub grown for its attractive fruiting capsules which are brilliant orange when split open. Sun or semi-shade.
<i>Pittosporum kirkii</i>	A small tree with dark green leaves and large yellow flowers in the summer. Prefers shade
<i>Pseudopanax crassifolius</i> horoeaka	Very narrow rigid and leathery leaves in its juvenile form. Stunning in amongst bold leaved plants. Sun or semi-shade.
<i>Pseudopanax lessonii</i> houpara	Small tree with attractive foliage. Tolerates full exposure and drought. Sun or semi-shade

Table 8-11: Grasses, ground covers and other plants

Grasses, ground covers, and other plants	Description
<i>Arthropodium cirratum</i> Rengarenga, renga lily	A lily with fleshy pale green – greyish leaves and white flowers. Ground cover in semi shady situation
<i>Asplenium bulbiferum</i> mouku, hen and chicken fern	A robust fern with small plantlets produced on the fronds. Tolerates dryness and prefers shade
<i>Asplenium oblongifolium</i> huruhuruwhenua, shining spleenwort	Fern with large shiny fronds. Tolerates dryness. Prefers shade
<i>Astelia banksii</i> kowharawhara, coastal astelia	Clump forming plant up to a metre high with flax-like leaves. Requires semi-shade. Tolerates full exposure. Frost tender
<i>Austrofestuca littoralis</i> hinarepe	Coastal dwelling grass. It has fine, rolled yellow-green leaves that fade at the tips to silver. It is found throughout New Zealand
<i>Astelia solandri</i> kowharawhara, perching astelia	An epiphytic plant in natural situations. Long drooping bright green leaves. Tolerates dryness. Prefers shade
<i>Carex flagellifera</i> manaia, Glen Murray tussock	Sedge up to 70cm high with reddish-brown spreading foliage. Prefers damp soil and full sun. Tolerates exposure
<i>Carex secta</i> Makura, purei	Green swamp tussock that is endemic to New Zealand. A common grass of swampy areas that often form thick trunk-like bases. Grows up to 1 metre tall.
<i>Carex testacea</i> sedge	Coastal sedge up to 40cm high with shiny orange foliage. Prefers full sun and exposure. Tolerates dry soil conditions
<i>Cortaderia fulvida</i> toetoe	Branching from the base and forming a clump to 4m high. Long strap-shaped leaves with red-orange coloured veins. Prefers good drainage and semi-shade
<i>Dianella nigra</i> turutu	Lily with reddish leaves, and striking violet-blue fruit. Ground cover; prefers open well-drained situation
<i>Disphyma australe</i> glasswort	Fleshy leaved ground cover with mauve flowers in the spring. Tolerates drought and full exposure. Frost tender

Grasses, ground covers, and other plants	Description
<i>Doodia media</i> pukupuku, rasp fern	Hardy fern growing to 25cm. Young fronds coloured bright red when in full sun. Sensitive to frost
<i>Libertia grandiflora</i> & <i>L. ixioides</i> mikoikoi, native iris	Clump forming native irises with narrow, upright leaves. Small white flowers in spring. Sun or shade
<i>Phormium cookianum</i> wharariki, mountain flax	Clump-forming flax with yellow – green drooping leaves, to 2m. Full exposure and sun
<i>Phormium tenax</i> harakeke, flax	Clump-forming flax with large stiff leaves, to 3 m. Full exposure and sun

New Zealand specific plant trials were undertaken¹¹² on two bioretention plants, *Carex secta* (green swamp tussock or purei) and *Austrofestuca littoralis* (sand tussock or hinarepe) and were found to grow satisfactorily in all bioretention mixes.

Regarding planting, the following recommendations are made:

- Species layout should generally be random and natural
- A canopy should be stabilised with an understory of shrubs and herbaceous plants
- Woody vegetation should not be specified in the vicinity of inflow locations
- Stressors (wind, sun, exposure) should be considered when developing the planting plan
- Noxious weeds should not be specified
- Aesthetics and visual characteristics should be given consideration
- Traffic and safety issues must be considered, and
- Existing and proposed utilities must be identified and considered.

8. Mulch

The placement of mulch can reduce filter media erosion, suppress weed growth and increase water availability for plants during establishment. A major concern with mulches is floating so steps have to be taken to reduce floating potential¹¹³. There are four steps that can reduce the risk of organic mulches floating.

- Thoroughly wet organic mulches at installation by irrigation.
- Design bioretention devices with sheet flow, or reinforce areas of concentrated flow with stone.
- Ensure a dense cover of plants is achieved with 24 months so re-mulching is unnecessary.
- Design the bioretention device with bypass of larger flows. Having an overflow pipe within the bioretention device enhances floating mulch transport out of the device.

9. High flow bypass

Larger flows may overwhelm the functional capability of bioretention devices to provide water quality treatment. A common discharge method is to have an outlet overflow pipe within the surface area of the filter media. This approach is not recommended as oils, greases, floating debris and mulch may exit the device and be discharged downstream. It is recommended that excess flow be diverted from entering the bioretention device

¹¹³ Simcock et al, 2013

so that the device is not overwhelmed. Several examples are shown in the following images. In both images larger flows bypass the bioretention devices.



8.5.4.7 Protection during construction / building phases

Bioretention devices must be protected during the building phase to ensure no dirty stormwater runoff enters the device.

If possible, bioretention devices should not be constructed until the surrounding areas have been stabilised and erosion is no longer a concern.

Incoming flows must be diverted until the bioretention device is fully planted and mulched and the contributing catchment area is stabilised.

8.5.4.8 Case study - Bioretention

Project description

A commercial parking lot is proposed in Tokoroa with a bioretention devices proposed due to aesthetic reasons and for dissolved metals. The total extent of the catchment being served is 4,000 square metres of which 60% is impervious with the remainder being landscaped. The overall slope is 3%

Hydrology

1. The 2-year 24-hour storm is 92.1 mm using a temperature increase of 2.1°C assumption for post-development rainfall increase to account for climate change.) so the water quality storm is 30.7 mm of rainfall.
2. The initial abstraction for the site is 3.4 mm so this requirement would set a minimum standard.
3. Soils are orthic pumice soils having a curve number of 79 due to water table concerns.
4. Calculate the water quality volume to be treated using the Waikato Stormwater Runoff Modelling Guideline (pervious and impervious volumes calculated separately and added together).

$$V_{wq} = 75 \text{ m}^3$$

Bioretention devices design

1. Live volume of storage needed $V_{live} = 0.40 (75 \text{ m}^3) = 30 \text{ m}^3$
2. Calculate the required surface area of the bioretention devices.

$$A_s = (WQV)(d)/k(h+d)t$$

Where:

- A_s = surface area of bioretention devices (m^2)
 WQV = water quality treatment volume (m^3)
 d = planting soil depth (m)

k = coefficient of permeability (m/day)
h = average height of water (m) = ½ maximum depth
t = time to pass WQV through soil bed

The following values should be used.

d = 0.85 metre
k = 0.75 m/d
h = 0.15 m (maximum water depth 300 mm)
t = 1 day

$$A_s = 75 (0.85) / 0.75 (0.15+0.85) (1)$$

$$A_s = 85.0 \text{ m}^2$$

Check to see that there is adequate live storage (30 m^3). Live storage available = surface area times maximum depth or $(85.0)(.3) = 25.5 \text{ m}^3$ so the bioretention devices surface area has to be increased by 4.5 m^2 to provide the necessary live storage which gives a surface area requirement of 89.5 m^2 .

In most cases, the live storage requirement will govern the size of the bioretention devices. If live storage can be provided upstream of the bioretention devices the overall size may not need to increase but the live storage must be available somewhere upstream.

8.5.5 Infiltration



<p>Description: Infiltration devices are designed and constructed to capture and treat stormwater runoff through:</p> <ul style="list-style-type: none"> • Filtration • Infiltration, and • Adsorption, and • Biological uptake 	Stormwater Management Function	
	<input checked="" type="checkbox"/>	Water quality <input checked="" type="checkbox"/> Metals <input checked="" type="checkbox"/> Sediment <input checked="" type="checkbox"/> TPH
	<input type="checkbox"/>	Flood protection
	<input checked="" type="checkbox"/>	Stream channel erosion protection

An infiltration device can be used to direct urban stormwater away from surface runoff paths and into the underlying soil. In contrast to surface detention methods, which are treatment or delay mechanisms that ultimately discharge all runoff to streams, infiltration diverts runoff into groundwater. Of all the traditional stormwater management practices, infiltration is one of the few (together with revegetation and rainwater reuse tanks) that reduces the overall volume of stormwater being discharged to surface water receiving environments.

Infiltration is used for three primary purposes:

- Reducing the total volume of stormwater runoff
- Reducing the contaminant loadings downstream, and
- Low streamflow augmentation.

The use of infiltration for water quality treatment must be considered with caution. Infiltration devices are much more sensitive to clogging than are ponds or filters. As much as possible, sediment should be prevented from entering infiltration devices.

As part of a stormwater treatment train, infiltration devices are a final stormwater management element, discharging stormwater runoff to ground/groundwater. It is therefore important to provide pre-treatment prior to infiltration devices.

8.5.5.1 Infiltration device variations

There are number of different variations of infiltration devices, including:

- Infiltration basins
- Trenches
- Soakage pits, and
- Modular block porous pavement.

Infiltration basin

An infiltration basin is essentially a pond that has no surface outlet. The only way for the water to leave the ponded area is for infiltration to occur. Figure 8-16 shows a schematic of an infiltration basin with an overflow outlet.

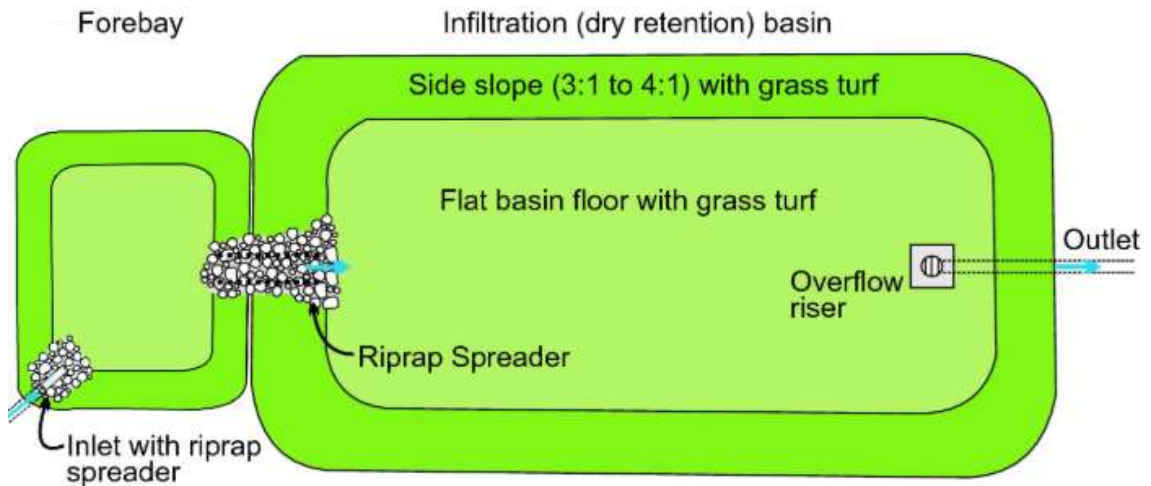

Figure 8-16: Schematic of an infiltration basin¹¹⁴

Infiltration basins are impounding facilities which temporarily store stormwater runoff and infiltrate a designated portion of stormwater into the ground surrounding the device.

Infiltration basins can also be designed to provide peak flow control. This is accomplished by providing “dry” storage above the designated infiltration volume. This dry, peak flow control volume is then released through a multi-stage outlet system.

Conceptually, an infiltration basin can be viewed as an extended dry detention basin whose water quality volume (or appropriate design volume) is infiltrated into the ground rather than being released slowly through an extended detention outlet.

Infiltration basins are not normally recommended for use because of long term performance issues that can arise due to clogging of the base of the basin. If an infiltration basin is proposed, specific design needs to be undertaken to address this issue, and pre-treatment is required.

Infiltration trench

Infiltration trenches receive runoff in a shallow excavated trench that has been backfilled with stone to form a below-grade reservoir as shown in Figure 8-17. Water then enters the underlying subsoil according to its infiltration rate.

¹¹⁴ https://link.springer.com/chapter/10.1007/978-3-030-11084-0_15

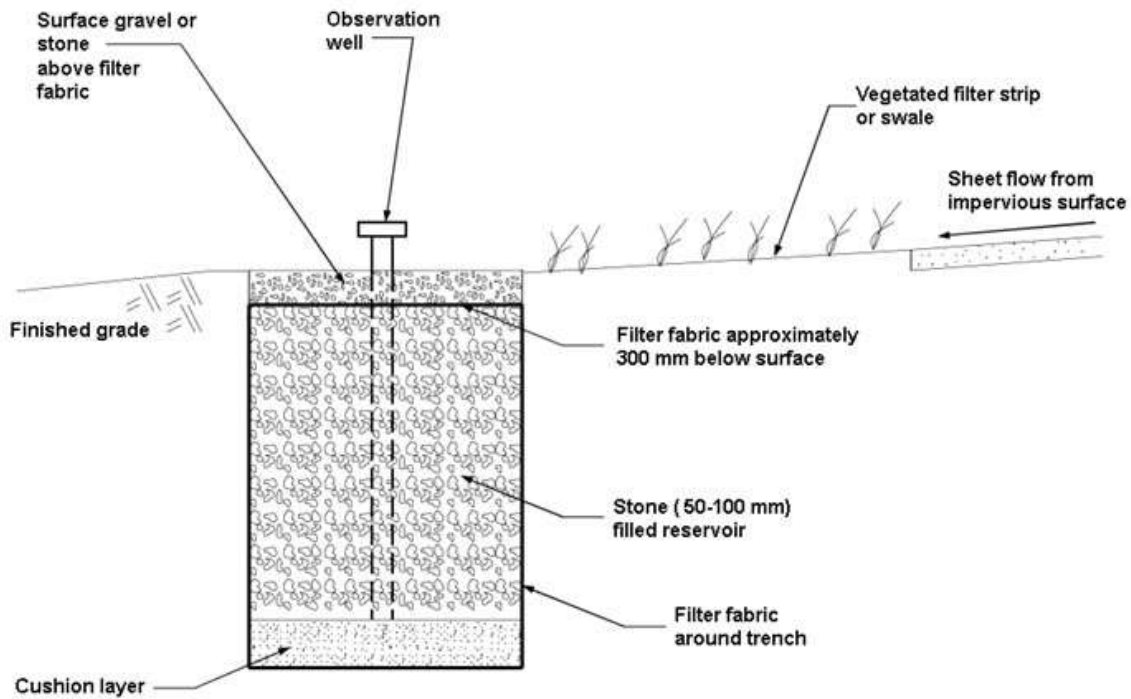

Figure 8-17: Schematic of an infiltration trench¹¹⁴

Soakage pit

Soakage pits function in a similar fashion with the excavated subgrade being filled with stone and relying upon the void spaces to provide for stormwater storage until the runoff infiltrates into the soil as shown in Figure 8-18.

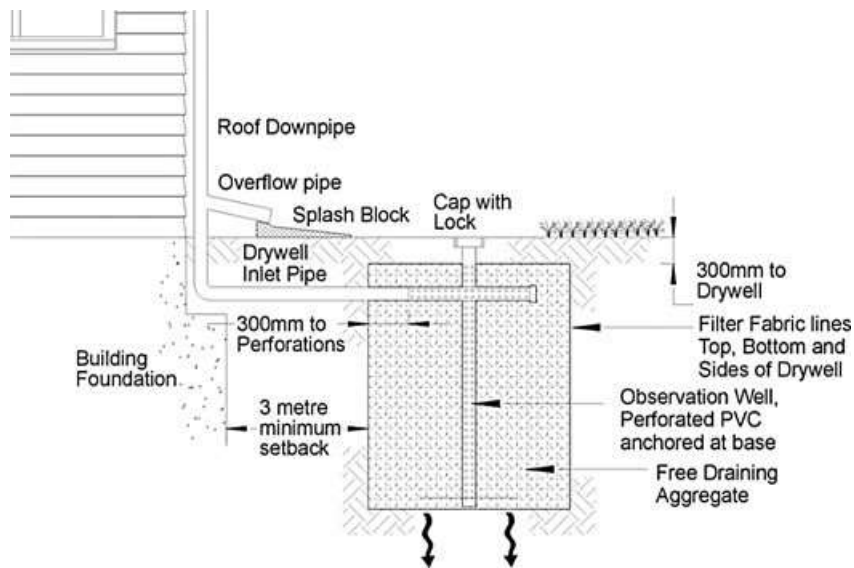

Figure 8-18: Schematic of a soakage pit¹¹⁵

Permeable pavement

Modular block permeable pavement permits precipitation to drain through paving blocks with a pervious opening as show in Figure 8-19. Paving blocks are appropriate only for areas with very light or no traffic or for parking pads. They are laid on a gravel subgrade and filled with sand or sandy loam turf but can also be used with grass in the voids which may require irrigation and lawn care during the summer months.

Permeable paving is designed only to capture rainfall falling on the surface. At this time it is not intended that the permeable surface provide infiltration for other impervious surfaces.

¹¹⁵ Auckland Regional Council, 2003

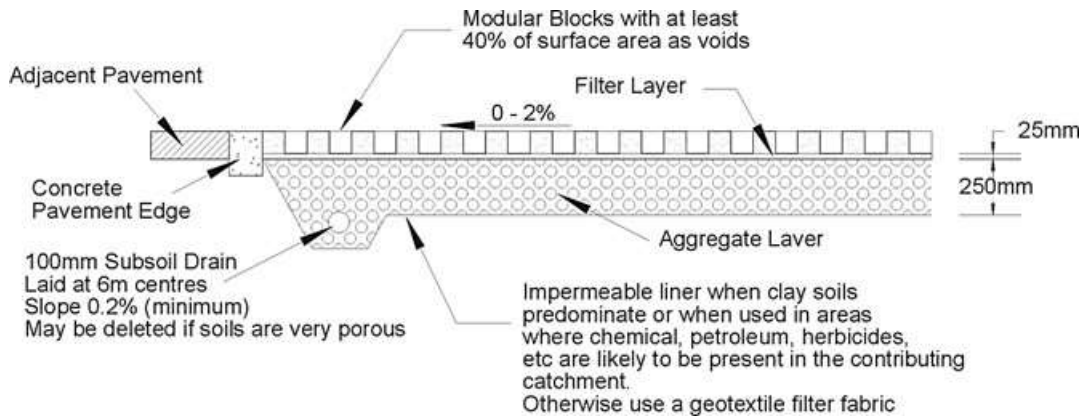

Figure 8-19: Schematic of permeable pavement¹¹⁵

8.5.5.2 Device components

Details for the standard components for infiltration devices are provided in the table below:

Table 8-12: Infiltration device components¹⁰⁶

Component	Description
Pre-treatment	Pre-treatment (through a swale or filter) prevents sediment entering the infiltration device and extends the life of the device. The only situation where pre-treatment is not required is when runoff has no contaminant load, such as roof water from residential areas.
Storage (optional)	There are different options to provide detention within an infiltration device, including within, above and below aggregate and can include storage chambers such as crates, arches and pipes.
Aggregate	Aggregate in the form of gravel, is used to create storage space within the device. Clean drainage aggregate to provide retention and detention storage comprising washed drain gravel 20 – 40mm diameter with defined void ratio of 0.3.
Geotextile layer	The sides and base of the infiltration device area lined with geotextile liner to prevent the migration of aggregate and sediments entering the base course. Geotextile must be secured at edges and base and all joints overlapped to prevent the movement of fine sediment between the device layer and base soils. It should be designed to prevent internal clogging.
Underdrains	Generally infiltration devices do not require underdrains. The infiltration rate of the existing natural soils should be sufficient to infiltrate all water into the underlying soils.
Overflow	Infiltration systems should be fitted with an overflow system in case a rainfall event exceeds the infiltration and storage capacity of the device.
Observation well	An observation well should be installed so that inspections can be made. Should consist of a perforated PVC pipe, 100-200mm in diameter and have footplate and a cap.

8.5.5.3 Applicability

There are a number of factors that need to be considered in the design and implementation of infiltration devices as shown in Table 8-13 below.

Table 8-13: Site constraints for the use of infiltration devices

Parameter	Constraint
Infiltration rate	Geotechnical assessment is required to confirm infiltration capacity of subsoils. Soils must have a minimum infiltration rate of 10 mm/hour after including a factor of safety of 50%. Thus the lowest measured rate shall be greater than 20 mm/hour. Infiltration should not be used if the infiltration rate is great than 1m/hr as this may indicate a direct link with a very permeable aquifer.
Pre-treatment	Pre-treatment is required to protect groundwater and the longevity of the device.
Clogging	Infiltration devices are not appropriate for sites with high contaminant loads. If clogged, the device is difficult and costly to refurbish.
Slope	Implementation on slopes exceeding 15% shall only be allowed with the concurrence of a geotechnical expert.
Fill material	Infiltration practices shall not be placed in fill material.
Catchment area	Catchment areas should not exceed 4 hectares, but preferably not more than 2ha.
Groundwater or bedrock proximity	The invert of infiltration practices shall be at least 1 metre above the seasonal high groundwater level (which is generally in late spring / early summer), bedrock, or relatively impermeable soil layer.
Location	Infiltration devices shall not be located near retaining walls, up gradient from houses or in gullies or floodplains. Infiltration devices shall not be located adjacent to underground power cables.
Groundwater	Potential impact on (contamination of) groundwater
Karst	The concentration of runoff into an infiltration device may result in the formation of flow channels. Such channels may lead to collapse in karst areas, hence infiltration basins should not be used in known karst areas.
Setback	Infiltration devices must be located at least 3m away from structures such as buildings, slopes, on-site wastewater systems and roads/trafficked areas
Contaminated land.	Infiltration is not suitable where contamination occurs or at high risk sites where chemical spills may occur

8.5.5.4 Design considerations

The following guidance is applicable to design and implementation of all infiltration devices.

Soil type / infiltration rate

Soil infiltration or permeability is the most critical consideration for the suitability of infiltration devices.

Infiltration devices should be constructed in medium textured soils with high permeability. They are unsuitable for use in soils with poor drainage. They are generally unsuitable for clay because of restricted percolation and for gravel and coarse sands because of the risk of groundwater contamination (unless effective pre-treatment is provided). Any impermeable soil layer close to the surface may need to be penetrated.

The underlying soils must be tested at the proposed site using either falling head or constant head permeability testing. A suitably qualified and experienced professional must undertake the soil testing. Under advisement of this expert, at least one test per 15m (for infiltration trenches) or 500m² (for non-linear infiltration surfaces) should be performed. The depth, number of test holes and samples should be increased if soil conditions are highly variable. The test bore hole should be 2.5 time deeper than the invert depth of the device, and not less than 3m below the proposed invert. Detailed bore logs should be prepared for each test borehole, along with a map showing the location. Further information can be found in the New Zealand Ground Investigation Specification, Volume 1¹¹⁶.

A maximum and minimum infiltration rate is specified to protect groundwater and to achieve contaminant capture objectives. Infiltration rates greater than 1 m/hr may indicate a direct link to a very permeable aquifer hence infiltration shall not be used if the measured infiltration rates are greater than 1m/hr. If the measured infiltration rates are less than 10mm/hr then infiltration shall not be implemented as the soakage rates are too slow to be effective.

Pre-treatment

Pre-treatment is required prior to infiltration devices (subject to the exclusions below) to reduce the potential for clogging to improve long term performance of the device and minimise operation and maintenance requirements. Pretreatment also serves to ensure groundwater is not contaminated by infiltrated runoff.

Infiltration devices accepting only roof runoff (in residential areas) do not require pre-treatment due to low contaminant loads in roof runoff. Pre-treatment is not possible for permeable paving.

A range of different devices can be used to provide pre-treatment including vegetated filter strips, swales and raingardens.

Infiltration basin having some pre-treatment with filter strips



Inlet stability

In addition to pre-treatment, long term function depends on having flows enter the infiltration device through a stable system that does not scour and increase sediment load to the device. Entry can be through various means including:

- Filter strips,
- Swales, or
- Reticulation systems.

If the filter strips or swales are designed in accordance with this guideline, velocities should not cause scour effects. If entry is via a reticulated system then velocities entering the device have

¹¹⁶ New Zealand Geotechnical Society, 2017.

the potential to cause scour, hence the inlet to the device would need to be stabilized appropriately.

Site stabilisation

Of primary importance to the long-term function of infiltration devices is the need to ensure all contributing catchment areas are stabilised. Sediment loadings into the device must be kept to a minimum. All inspections of these devices must include inspection for site stabilisation. All areas draining to the infiltration device must be stabilised or premature clogging of the facility will result. Infiltration devices should have annual inspections undertaken for assessing sediment accumulation. The frequency of actual maintenance activities depends on loadings from contributing catchment areas.

8.5.5.5 Objectives

Because infiltration devices are one of only a few devices that reduce the total volume of runoff, objectives relate to:

- Stormwater volume reduction,
- Contaminant removal, and
- Low stream flow augmentation.

Due to the sensitivity of infiltration devices to clogging, they are best utilised to augment low stream baseflow and reduce stormwater runoff volumes, with pretreatment provided to reduce contaminant loads so that the infiltration device will not fail due to premature clogging or allowing contaminant migration to groundwater.

If long-term responsible maintenance can be assured, infiltration is appropriate as a water quality treatment practice.

Infiltration meets the initial abstraction retention criteria if designed for retention of runoff from at least the water quality storm. The infiltration device shall be designed recognizing the limitations placed on site suitability as detailed in Table 8-13 and there must also be recognition that in catchments where nutrients are a concern (primarily lake catchments) two devices in series shall be used in accordance with Section 7.4.3.

8.5.5.6 Protection during construction / building phases

Infiltration devices must be protected during site development and house building phases to ensure contaminated stormwater runoff does not enter the device.

If possible, infiltration devices should not be constructed until the surrounding areas have been stabilised and erosion is no longer a concern. Where this isn't possible, incoming flows must be diverted around infiltration devices until the contributing catchment area is stabilised.

8.5.5.7 Detailed design procedure

This design approach relies on Darcy's Law, which expresses flow through a porous media. There are two equations that are used: one for surface area of the device (A_s) and one for its volume (V). A third equation provides a check that the maximum depth is not exceeded in the design to ensure that the device drains in the two day drain period.

In terms of the design approach:

1. Determine the water quality rainfall (1/3 of the 2-year 24-hour duration event).
2. Calculate the water quality volume.
3. Size the device surface area to allow complete infiltration within 48 hours, including rainfall falling directly on it. Use the following equation to determine surface area:

$$A_s = \frac{WQV}{(f_d)(i)(t) - p}$$

Where:

- A_s = surface area of the trench (m²)
- WQV = water quality volume (m³)
- f_d = infiltration rate (m/hr) - rate reduced by ½ from measured
- i = hydraulic gradient (m/m) - assumed to be 1
- t = time to drain from full condition (hours) - maximum time 48 hours.
- p = rainfall depth for water quality storm (m)

There is a simple test to see how deep an infiltration device can be to achieve the discharge of the water quality storm. Any deeper than the amount calculated will not achieve the two-day draw down period. The equation is the following:

$$d_{max} = f_d (t / V_r)$$

Where:

- d_{max} = Maximum depth of trench
- f_d = Infiltration rate (m/hr)
- t = Time to drain from full condition (hours)
- V_r = Void ratio (0.3 for aggregate or 1 for infiltration basins)

Once d_{max} has been defined, the actual needed depth can be calculated. If the actual depth exceeds the maximum depth the surface area must be increased to account

4. Find the device volume to provide storage for 37% of the volume required to infiltrate. This allows for storage of excess runoff during those periods when the runoff exceeds the infiltration rate.

$$V = 0.37 (WQV + p A_s) / V_r$$

Where:

- V = Device volume with any aggregate added

NOTE: Permeable paving does not usually have a contributing drainage area draining to it. As such the volume of storage equals the following:

$V = p A_s / v_r$ where p is the design rainfall event (at least the water quality storm but generally will be up to the 10-year ARI rainfall event)

5. Calculate the device depth and compare with the maximum depth

$$V/A_s = \text{depth of trench } (d)$$

If $d < d_{max}$ the design is adequate. If $d > d_{max}$ then the surface area must be increased and depth decreased.

Infiltration devices direct urban stormwater away from surface runoff paths and into the underlying soil. In contrast to surface detention methods, which are treatment or delay mechanisms that ultimately discharge all stormwater runoff to streams, infiltration devices divert runoff into groundwater.

8.5.5.8 Case study - Infiltration

Project description

A small commercial development in Cambridge is proposed with the development being 80% impervious and the total development size is 3000 m². Average slope of the site is 5%, pre-development land use is pasture and the soils are orthic allophanic soils having a curve number of 79. Post-development land use is open space lawn with good grass cover having a curve number of 74 due to the open space soil being conditioned to promote infiltration. With the soil conditioning, the runoff from the grassed areas is less than in the pre-development pasture

condition so no management is necessary for the grassed areas and that flow can bypass the infiltration trench and thus reduce its size.

1. The 2-year 24-hour post-development storm with climate change is 78.5 mm using a temperature increase of 2.1°C assumption for post-development rainfall increase to account for climate change so the water quality storm is 26.2 mm of rainfall.
2. The 10-year 24-hour post-development storm with climate change is 125.7 mm.
3. The initial abstraction for pervious areas should be retained on site as a minimum, which in this case is 3.4 mm. Depending on site conditions the infiltration of the water quality storm will exceed the initial abstraction, which hence meets the retention criteria.
4. Soils are orthic pumice soils having a curve number of 79 due to water table concerns.
5. Infiltration rate through testing is 20 mm/hour. Taking ½ of that rate results in using 10 mm/hour for design purposes.
6. Calculate the water quality volume to be treated using the Waikato Guideline for Stormwater Runoff Modelling. As the pervious areas bypass the trench, storage only needs to be provided for the impervious surface.

$$\begin{aligned}V_{wq} &= 52 \text{ m}^3 \\V_{2\text{-yr}} &= 176 \text{ m}^3 \\V_{10\text{-yr}} &= 289 \text{ m}^3\end{aligned}$$

Infiltration trench design

1. Calculate the device surface area

$$A_s = \frac{WQV}{(f_d)(i)(t) - p}$$

Where:

$$\begin{aligned}A_s &= \text{surface area of the trench (m}^2\text{)} \\WQV &= \text{water quality volume (m}^3\text{)} = 52 \text{ m}^3 \\f_d &= \text{infiltration rate (m/hr) - rate reduced by } \frac{1}{2} \text{ from measured} = 20 \text{ mm/hour reduced by } \frac{1}{2} \text{ as a factor of safety, so } f_d = 10 \text{ mm/hour} = 0.01 \text{ m/hour} \\i &= \text{hydraulic gradient (m/m) - assumed to be 1} \\t &= \text{time to drain from full condition (hours) - maximum time 48 hours} \\p &= \text{rainfall depth for water quality storm (m)} = 0.026 \text{ m}\end{aligned}$$

$$A_s = 52 / ((0.01 \times 1 \times 48) - 0.026) = 114 \text{ m}^2$$

Calculate the maximum trench depth

$$d_{max} = f_d \left(\frac{t}{V_r} \right)$$

Where:

$$\begin{aligned}d_{max} &= \text{Maximum depth of trench} \\f_d &= \text{Infiltration rate (m/hr)} = 0.01 \text{ m/hour} \\t &= \text{Time to drain from full condition (hours)} = 48 \text{ hours} \\V_r &= \text{Void ratio of aggregate} = 0.3 \\d_{max} &= 0.01 \times (48 / 0.30) = 1.6 \text{ m}\end{aligned}$$

2. Find the trench volume

$$V = 0.37(WQV + pA_s) / V_r = 0.37 (52 + 0.026 (114)) / 0.3 = 67.8 \text{ m}^3$$

3. Calculate the trench depth and compare with the maximum depth

$$V/A_s = \text{depth of trench (d)} = 67.8 / 114 = 0.59 \text{ m}$$

$d < d_{max}$ so the design is adequate.

In a similar approach the trench could be sized for the 2-year or even 10-year runoff volumes. Those volumes have been provided in item 6 of the project description section of this case study.

8.5.6 Stormwater pond



<p>Description: Stormwater ponds can provide:</p> <ul style="list-style-type: none"> • Peak flow control • Extended detention, and • Some water quality treatment. <p>Processes for contaminant reduction are primarily related to:</p> <ul style="list-style-type: none"> • Sedimentation 	<p>Stormwater Management Function</p> <table> <tr> <td data-bbox="794 701 874 768">✓*</td> <td data-bbox="970 674 1126 703">Water quality</td> </tr> <tr> <td></td> <td data-bbox="970 707 1114 736">~ Metals</td> </tr> <tr> <td></td> <td data-bbox="970 736 1134 766">✓ Sediment</td> </tr> <tr> <td></td> <td data-bbox="970 766 1086 795">~ TPH</td> </tr> <tr> <td></td> <td data-bbox="970 795 1161 846">~ possibly through specific design</td> </tr> <tr> <td data-bbox="794 862 874 929">✓</td> <td data-bbox="970 878 1155 907">Flood protection</td> </tr> <tr> <td data-bbox="794 940 874 1008">✓</td> <td data-bbox="970 934 1177 990">Stream channel erosion protection</td> </tr> </table> <p>* Up-catchment treatment required</p>	✓*	Water quality		~ Metals		✓ Sediment		~ TPH		~ possibly through specific design	✓	Flood protection	✓	Stream channel erosion protection
✓*	Water quality														
	~ Metals														
	✓ Sediment														
	~ TPH														
	~ possibly through specific design														
✓	Flood protection														
✓	Stream channel erosion protection														

A stormwater pond is a constructed stormwater management device that collects and detains stormwater runoff from an upstream contributing catchment. A pond can be designed to provide detention of flows to help mitigate downstream flood risk and to protect streams from erosion and scour effects. Stormwater ponds can provide some water quality treatment, however additional up-catchment treatment is required to mitigate potential downstream adverse effects.

This section provides details about ponds that are either normally dry or normally wet. Both forms of pond can and may possibly have an extended detention component to them. This section does not include discussion of wetlands. Wetlands, while having much in common with stormwater ponds are considered separately in Section 8.5.7.

Ponds can be designed to be dry or wet, the following summarises the key differences:

Dry pond - A constructed pond that temporarily detains stormwater runoff to control the peak rate of discharge to mitigate potential flood effects, and can provide extended detention to help mitigate downstream erosion and scour effects. These ponds are designed to be dry between storm events.

Wet pond - A constructed pond that has a permanent pool of standing water with live storage provided above this to attenuate peak flows during rainfall events. These ponds can provide some water quality treatment. They can also provide extended detention to help mitigate downstream erosion and scour effects. Increased water temperature associated with the standing water can have a significant adverse effect on receiving environments.

Stormwater ponds are used for three primary purposes:

- Reducing downstream flood potential
- Providing some water quality treatment (dry ponds are not considered to provide water quality treatment), and

- Minimising, to the extent possible, downstream channel erosion.

It may not be necessary in every situation to address all three purposes, but there will be sites, as discussed later in this section, where all three functions will be included in the design.

8.5.6.1 Water quantity/quality performance

Ponds detain stormwater runoff, typically from a design storm, and then discharge it, usually at the pre-development peak discharge rate.

Traditionally ponds have been used to provide flood protection. They normally detain runoff and then discharge it at a specified rate, reducing the potential for downstream flooding by delaying the arrival of runoff from upper parts of a catchment. More recently, wet and dry pond designs have been modified to extend the detention time of runoff thereby increasing the potential for the settling out of particulates and minimising downstream channel erosion. Wet ponds are designed to have a permanent pool for storage of a specified water quality volume, in the Waikato Region this is the water quality storm. Live storage to attenuate peak flows is provided above the permanent pool.

Contaminant removal mechanism

The primary contaminant removal mechanism of all pond systems is settling or sedimentation of sediments. However, the effectiveness may vary to some degree depending on the type of detention system (dry or wet).

Dry detention ponds with no extended detention have limited effectiveness at providing sedimentation, as detention times may be several hours only, so only the coarser particles can be removed from the water column.

Dry extended detention ponds also rely on sedimentation during short periods of live storage only although they typically hold flows for longer than flood detention ponds.

The best approach for particulate removal when using ponds is the combination of extended detention with a normal wet pool. The pool allows for displacement of water previously stored and the extended detention allows for better sedimentation of excess storm flows. However, increased water temperature associated with the standing water in the pond can have a significant negative impact on receiving environments.

Expected performance

Ponds can be effective at reducing peak discharge rates. Depending on their design and their location within a catchment, they may also be effective in reducing downstream channel erosion, downstream flood levels and flooding.

Effectiveness at contaminant removal depends on the type of pond system. Dry ponds are not considered to achieve adequate water quality treatment. If used they need to be included in a treatment train with up-catchment water quality treatment provided. Wet ponds provide better treatment than a dry pond, however have adverse thermal effects associated with the standing water, hence specific outlet arrangements are required to mitigate thermal effects if discharging directly to a watercourse. Up-catchment water quality treatment is also required for wet ponds to achieve adequate water quality treatment.

In all instances, wetlands are preferred to ponds. Ponds must be off-line from waterways.

Constraints on the use of ponds

Dry ponds

- Need fairly porous soils or subsurface drainage to assure that the bottom stays dry between storms
- Not suitable in areas with high water tables or shallow depth to bedrock
- Not suitable on fill sites or steep slopes unless geotechnically checked

- May not be suitable if receiving water is temperature sensitive as detention ponds do not detain water long enough to reduce temperatures from impervious surfaces.

Wet ponds

- Not suitable on fill sites or near steep slopes unless geotechnically checked
- May need supplemental water supply or liner system to maintain permanent pool if not dug into the groundwater
- Minimum contributing drainage area of 6 hectares is needed to maintain the permanent pool
- Not feasible in very dense urban areas or areas with high land costs due to large surface area needs
- May not be suitable if receiving water is temperature sensitive due to warming of pond surface area.
- Safety issues need to be addressed, depending on normal pool depth

Dry flood detention ponds are not recommended for stormwater management systems. They have ongoing maintenance needs because standing water in areas where positive drainage is impeded may cause mosquito problems, and their overall performance for water quality treatment is less than provided by wet ponds. A study in the United States¹¹⁷ indicated that over 70% of the dry ponds in a given jurisdiction were not functioning as designed.

8.5.6.2 Pond component disclaimer

The technical safety criteria for pond design and construction that are beyond the scope of this document include:

- Minimum dam top width
- Embankment side slopes
- Seepage control
- Foundation standards
- Foundation cutoff
- Outlet protection
- Access and set aside area for sediment drying

Two issues that will be discussed in this section are minimum spillway capacity, as spillway design will affect the duration of detention and therefore stormwater quantity and quality control, and pond forebay areas and capacity. These will be discussed in the Design Procedure section.

A typical wet pond is shown in Figure 8-20 and Figure 8-21.

¹¹⁷ DNR, 1986

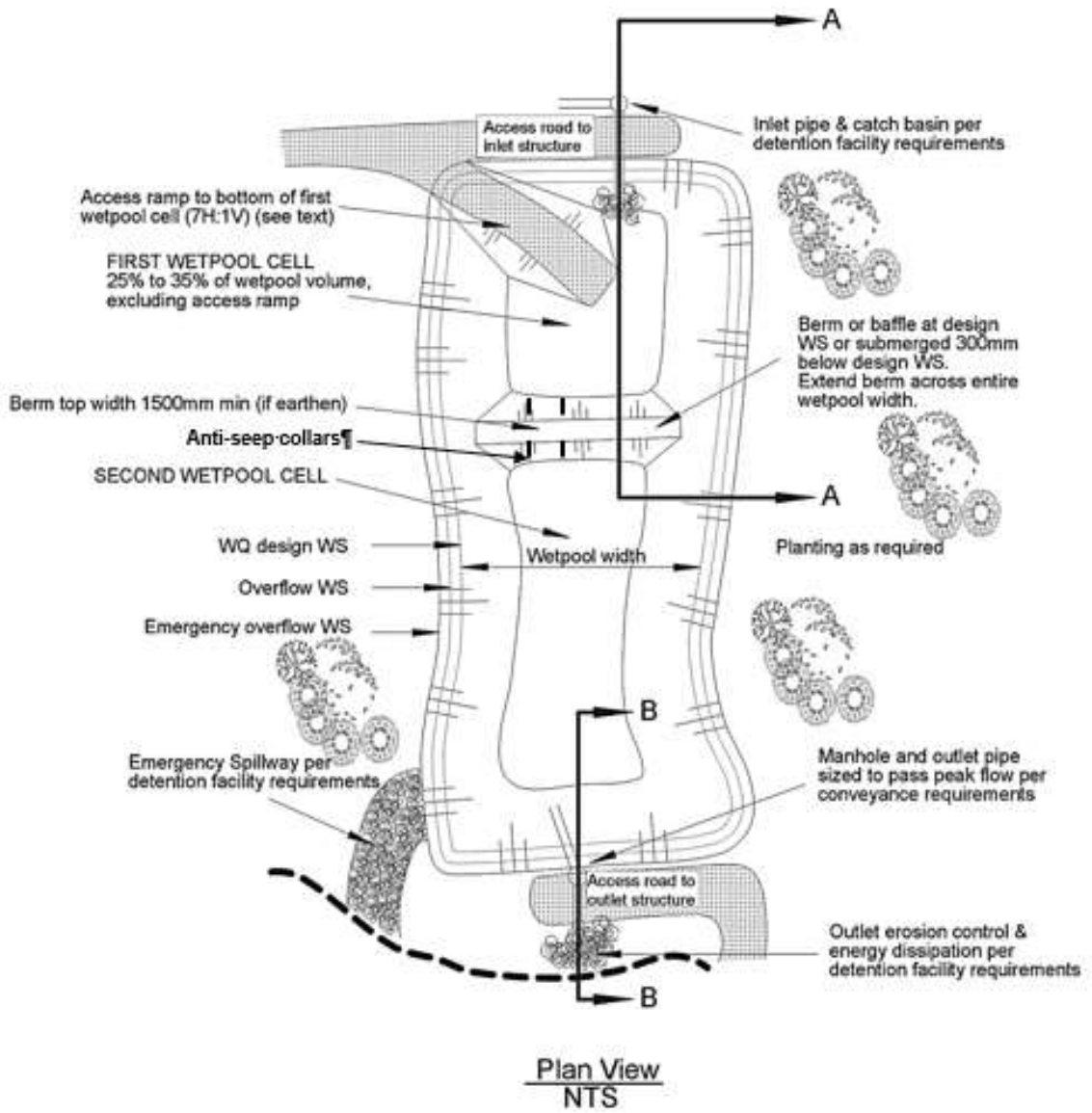

Figure 8-20: Schematic of a stormwater management pond¹¹⁸

¹¹⁸ Auckland Regional Council, 2003

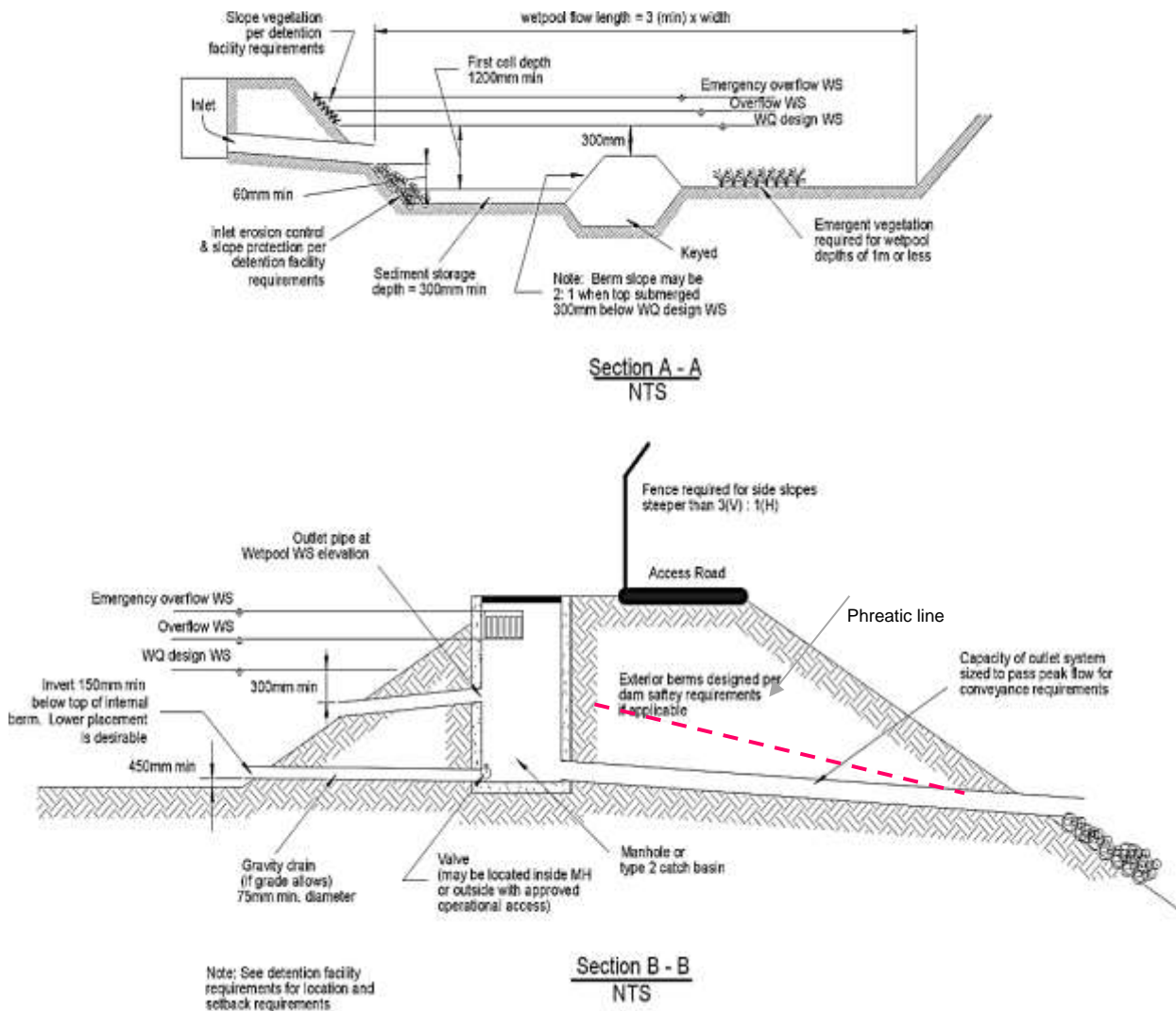

Figure 8-21: Pond cross-sections¹¹⁸

The issue of seepage control is important to the long-term stability of a dam. The Bay of Plenty Regional Council advocates a filter collar approach rather than using anti-seep collars. A standard detail of a filter collar is shown in Figure 8-22. Either the use of anti-seep collars or filter collars for seepage control is considered acceptable to Waikato Regional Council, however construction adequacy must be ensured for either one.

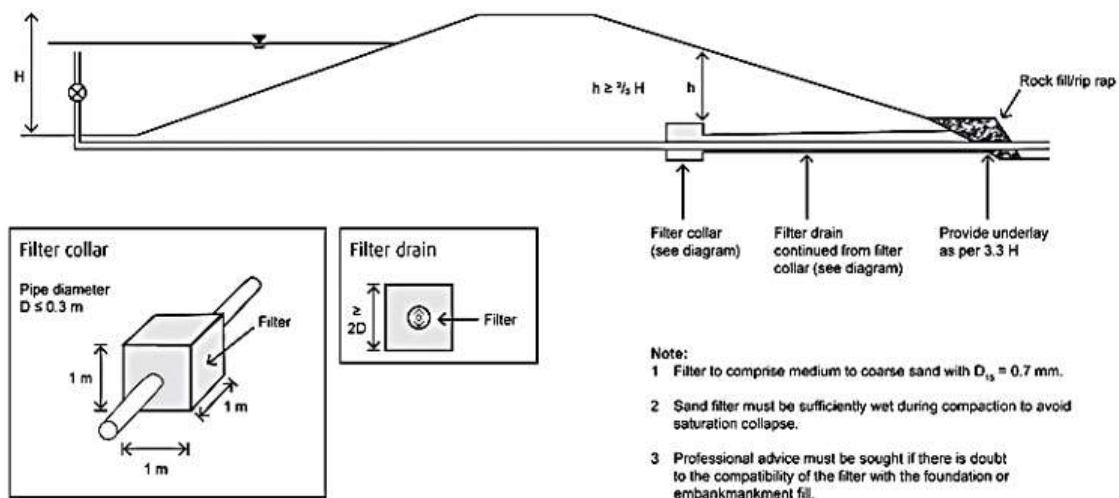

Figure 8-22: Design detail for a filter collar¹¹⁹

¹¹⁹ Bay of Plenty Regional Council, 2012

If a filter collar is the intended seepage control practice, then the media shall be sand meeting ASTM C-33 fine aggregate. If unusual soil conditions exist such that this material may not meet the required filter or capacity requirements, a special design analysis shall be made.

8.5.6.3 Design approach

Objectives

Water quantity objectives

Urbanisation has dramatic impacts on the amount of stormwater runoff that is generated from a catchment. Ponds, when properly sized, can be a primary quantity control practice.

Waikato Regional Council criteria for water quantity control depend on the receiving environment. If the receiving environment is a piped stormwater reticulation system with adequate capacity for the increased runoff or tidal (either estuarine or marine), then water quantity control is not an issue and a number of devices can be used to achieve water quality goals. If the receiving environment is a stream, then control of peak rates of runoff may be a requirement, and ponds become a primary option for controlling discharge rates.

Water quality objectives

Water quality objectives aim for removal of total suspended solids. Ponds are not as appropriate for dissolved contaminants so treatment of metals may require other devices to be used in conjunction with ponds. They are more appropriate where sedimentation can achieve stated goals.

Where possible, water quality ponds need a bypass for larger flows. Because all flows travel through the pond, water quality performance during larger events will be reduced as first flush contaminants are carried through it. Ideally, larger flows should bypass the pond in order to avoid a drop in water quality performance, albeit at the expense of its ability to provide peak flow reduction for larger storms.

In those situations, it may be best to use a treatment train approach to stormwater where other devices provide primary water quality treatment while the pond is primarily used for water quantity control. Although desirable, this approach may not always be possible due to site constraints.

There is a direct linkage between water quality treatment and extended detention flow control. If catchment considerations necessitate that extended detention is required, 50% of the calculated water quality volume can be placed as dead storage while 50% of the water quality volume can be live storage and released as part of the extended detention rainfall capture and release requirement.

The permanent storage will reduce flow velocities entering and through the pond, while the extended detention will facilitate (in addition to the wet pool) settlement of particulates.

If there is no requirement for extended detention, the entire water quality volume must be stored within the permanent pool level.

As discussed in Section 7.3.1, in areas where the quality event rainfall is greater than 30mm, water quality treatment should be designed using a rainfall depth of 30mm to determine the water quality volume. This only applies to water quality criteria. Extended detention will require design for the full, un-adjusted rainfall depth.

Channel protection objectives

Urban development has the effect of increasing the frequency and magnitude of floods, particularly during frequent small storm events. As a consequence, streams can suffer an increase in erosion, as channels enlarge to cope with the increased storm response. The objective of criteria related to channel protection is to maintain or improve the in-stream channel stability to protect ecological values of the stream and reduce sedimentation downstream.

Waikato Regional Council may require on a case-by-case basis that the runoff from 1.2 times the water quality volume to be stored and released over a 24-hour period to minimise potential for stream channel erosion.

This provision is in addition to normal stormwater quality and flow attenuation requirements. However, by using extended detention for some of the stormwater quality treatment rather than a full wet pond, the treatment and erosion attenuation volumes may be partially combined, reducing total pond volume.

Ponds in series

Waikato Regional Council does not generally recommend the use of ponds in series instead of a single pond with an equivalent surface area. If the single pond were divided into two ponds in series then each of the two ponds would have approximately 1/2 of the surface area of the single one. Each pond then has half the detention time, so the first pond takes out the coarser sediment. The flow is then remixed in the channel between ponds, and the second pond is too small to take out the finer fractions. Therefore ponds in series may be less efficient than single large ponds of equivalent volume.

However, sometimes site constraints make it necessary to use two or more treatment ponds in series rather than one larger single pond. To offset the reduction in sediment removal, where two or more ponds in series are necessary they should be sized for 20% greater volume than the volume specified in this guideline for a single pond. Where there are no specific site constraints, a single pond is preferred. This does not translate to wetlands, refer to Section 8.5.7.1.

8.5.6.4 Preferences

Preference for wetlands versus ponds

Constructed wetlands are preferred to open water ponds because they provide better filtration of contaminants, including dissolved ones due to densities of wetland plants, incorporation of contaminants in soils, adsorption, plant uptake, and biological microbial decomposition (more in-depth discussion is provided in Section 8.5.7). In addition, wetlands, being shallow water bodies do not have the safety issues associated with deeper wet ponds.

Wet ponds can only be implemented when consideration for a wetland has been rejected and the rejection is acceptable to Waikato Regional Council.

Wet ponds can cause adverse thermal effects on downstream receiving environments hence can only be considered for appropriate receiving environments, and where it can be demonstrated that other practices have been investigated and rejected for valid reasons.

On-line versus off-line

Waikato Regional Council recommends that ponds be 'off-line' rather than 'on-line'. Off-line ponds are considered to be those ponds not physically located in perennial watercourses. They can be in gullies or upland areas. On-line ponds are located on streams having perennial flows and their impact to the stream itself can be significant. On-line ponds alter geomorphic and biological character of streams and these alterations may adversely impact on the streams natural character and function.

There may be some circumstances where on-line ponds would be considered suitable. On-line ponds will be considered on a case-by-case basis by Waikato Regional Council.

If an on-line pond is proposed, the following requirements apply:

1. Water quality treatment must be provided upstream and off-line.
2. Storage must be provided by dry detention with a naturalised channel provided at the base to convey the natural stream flows (i.e. storage would be provided within the floodplain of the stream in effect)

Dry ponds versus wet ponds

Dry ponds need more maintenance and have a lower water quality performance than wet ponds. In terms of preference when ponds are the selected options, constructed wetlands are a first choice, followed by wet ponds, and finally dry ponds.

Dry ponds are not normally recommended unless there is council acceptance that a dry pond is an acceptable stormwater management approach in a specific situation. The acceptable use of a dry pond will generally be associated with an on-line pond configuration, whereby the storage is provided by dry detention in the floodplain with a naturalised low flow channel provided.

If a dry pond is determined to be acceptable in a case-by-case situation there are several points that need to be addressed:

- The bottom of the pond shall have a bottom slope of at least 2% towards the outlet to minimise the potential of standing water that can become a mosquito breeding area.
- The bottom shall be stabilised to prevent suspension of sediment. A vegetative cover, such as oi oi, should provide a dense growth of vegetation and minimise safety issues by being less interesting for children to play within.

Maintenance responsibility

The issue of ensuring an entity is responsible for maintenance must be considered as an issue to determine whether ponds are applicable in a given situation. Ponds are expensive and require routine and non-routine maintenance to ensure proper long-term performance or failure of the pond system can occur. While a swale can fill in or a sand filter clog, pond failure can have significant effects, such as property damage and potential loss of life. Ponds must therefore be regarded as small dams, and evaluated in the context of best practice for dam operation. If maintenance responsibility cannot be defined during the design phase, ponds should not be selected for a given site.

Safety features

Depth

Deeper ponds can be attractive to children who like open water. Historically, ponds have been 1 - 3 metres deep, sometimes over anyone's head. Stormwater ponds should not be deeper than 2 metres unless justified for a specific reason, such as rural fire water source. If water quality volume requirements and site limitations limit pond area, then use a wetland and extended detention live storage to achieve the water quality volume.

Benches

A reverse slope bench or slope break should be provided 300 mm above the normal standing water pool (where there is a normal pool) for safety purposes. All ponds should also have a shallow bench 300 mm deep that extends at least three metres from the shoreline, before sloping down to the pond floor. This shallow bench will facilitate the growth of emergent wetland plants and also act as a safety feature.

In addition to the benches, the steepness of the pond slope down to the invert of the pond should not exceed 4 horizontal to 1 vertical. Steeper slopes will make it very difficult for someone who is in the pond to get out of it. A schematic of pond safety features is shown in Figure 8-23.

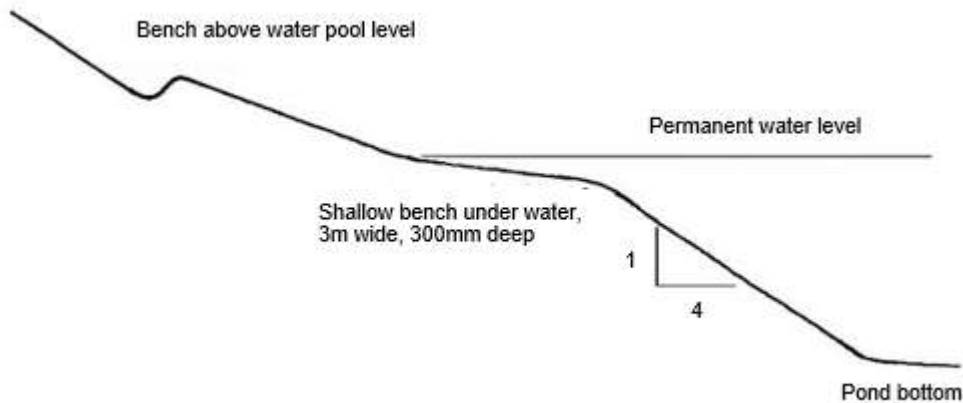

Figure 8-23: Schematic of safety benches and slopes

The reverse slope above the waterline has at least three functions, including the following:

1. Reduces rill erosion that normally would be expected on longer slopes.
2. Intercept sediment traveling down slope and conveys them to the pond inflow.
3. Provides an additional safety feature to reduce the potential for children running or riding uncontrolled down the slope and falling into the pond.

Fences

Waikato Regional Council does not require fencing of ponds, as it is considered that use of natural features such as reverse benching, dense bank planting, and wetlands buffers (which consists of a dense stand of vegetation) will provide a similar level of protection. The fencing requirement may be reconsidered on a case-by-case basis and also may be required by the various city and district councils.

Aesthetics

Aesthetics must be considered as an essential pond design component. Ponds can be a site amenity if properly designed and landscaped or can be a scar on the landscape. The developer and designer should consider the pond as if they themselves were to be living in the development. Small items can have a big influence on the livability of a given area to residents and the best time to consider the issue is during the design phase. There is a greater discussion of landscaping later in the guideline.

8.5.6.5 Design procedure

Approach

Pond design tasks, in order, include the following:

1. Determine the need for water quantity control. In normal situations if it is required, that requirement will be to limit post-development peak discharges for the 2 and 10-year ARI rainfall events to their pre-development peak discharge release rates.

If downstream flooding is documented, the post-development 100-year ARI storm peak discharge rate may also need to be limited. In this case, a catchment analysis may be necessary or, as an option to the catchment analysis, limiting the 100-year ARI peak discharge to 80% of the pre-development peak release rate.

2. From the initial abstraction calculate the volume of retention as detailed in Section 7.2.7. That volume can reduce the water quality and extended detention volume storage requirement.
3. Protect channel form in receiving environment. If the discharge enters a perennial natural stream channel, its channel will need to be protected from erosion. In such cases the water quality volume or 1.2 times the water quality volume shall be stored and released over a 24 hour period.

- Determine the need for water quality control. Calculate the water quality volume that needs to be treated when detention is required, and provide at least 50% of that volume as permanent pond storage. The other 50% stores and releases runoff from either the water quality volume or 1.2 times the water quality volume over a 24 hour period.

A hydrological analysis is needed for up to five rainfall events including the 2-year, 10-year and possibly 100-year ARI events, plus the water quality event and 1.2 times the water quality event (for erosion protection). The 2, 10, and 100-year ARI events must be undertaken for both pre- and post-development while 1.2 times the water quality rainfall (erosion protection) and water quality rainfall events are based on the post-development condition that includes an allowance for climate change.

Spillways and outlet capacity

There are two primary outlets from a pond: the service outlet and the emergency outlet. They will be discussed in the context of their sizing. Figure 8-24 illustrates the various outlet elements and components. The terms detailed in the figure are those used in the Hydraulic Flow discussion of this chapter.

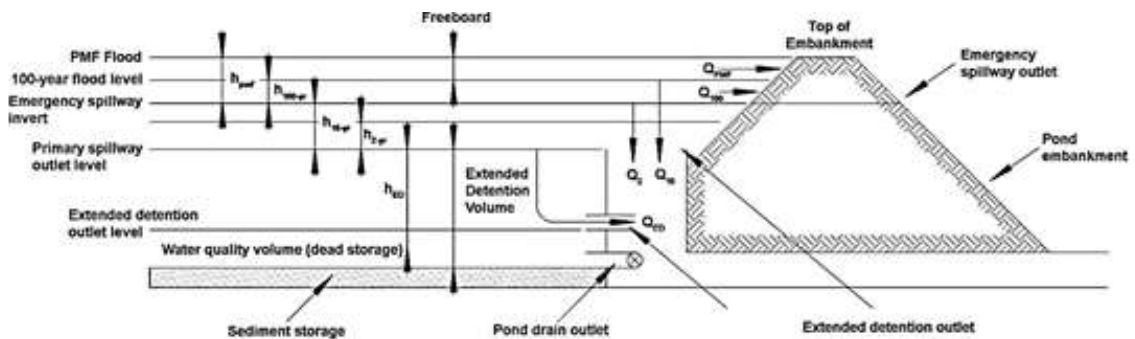

Figure 8-24: Schematic of pond outlet components¹²⁰

Service outlet

The service outlet should be designed to at least accommodate the flows from the primary drainage system entering the pond. The service outlet will normally convey the flow from the extended detention orifice, the 2-year storm and the 10-year storm. In addition, the service outlet should also have a gate valve at the invert of the normal pool to allow for drainage of the pond during maintenance.

When an extended detention orifice is required, that orifice shall not be less than 50 mm in diameter (or 50 mm wide if a slot) unless a cover plate or screen device is used to prevent clogging of the orifice as shown in Figure 8-25. If calculations indicate an orifice (or slot) of smaller size, attention must be given to implementation of protective measures such as cover plate or other means, to prevent blockage of the orifice. It is important to consider blockage on all outlet devices but the extended detention outlet will be highly susceptible to blockage unless specifically designed for.

¹²⁰ Auckland Regional Council, 2003

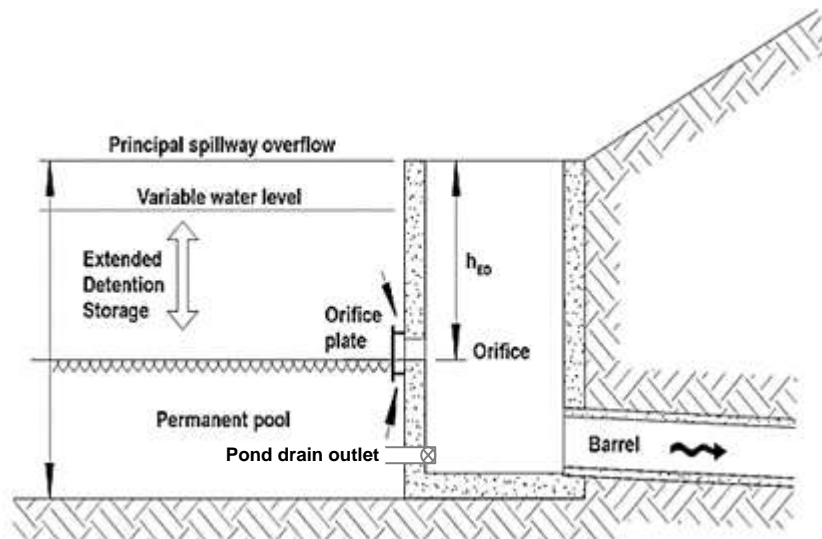

Figure 8-25: Example of an orifice cover plate to prevent clogging¹²¹

Two points are important when using a cover plate.

1. The cover plate should be less than the diameter of the orifice from the orifice wall. If the orifice is 40 mm in diameter, the orifice plate should be no more than approximately 35 mm from the wall.
2. A good rule of thumb is to have the opening area of the orifice plate at least 5 times the area of the orifice. This would include the area from all four sides (if a rectangular plate is used).

Emergency spillway

The emergency spillway will convey flows beyond the service spillway's capacity. It should be designed to convey at least the 100-year ARI storm with a freeboard of at least 300 mm.

The emergency spillway should be located in natural ground and not placed on fill material unless it is armored to prevent scour of the embankment. Operating velocities must be calculated for spillways in natural ground in order to determine the need for additional armoring. If the emergency spillway is placed on fill, the embankment should be constructed higher than the final design to allow for settlement.

In situations where embankment failure may lead to loss of life or extreme property damage, the emergency spillway must be able to:

- Pass an extreme flood, which may be the Probable Maximum Precipitation (PMP), with no freeboard (after post-construction settlement) and with the service outlet blocked. The PMP is defined as an estimate of an upper physical bound to the precipitation that the atmosphere can produce¹²². The extreme flood (Q_v) is defined in NIWA's document detailed in "*A Guide to Probable Maximum Precipitation in New Zealand*"¹²³. For high-risk dams, discussion with Waikato Regional Council is essential to determine the needed factor of safety.
- Pass the full Q_v (100-year ARI flow) assuming the service spillway is blocked with at least 0.5 metres of freeboard (after construction settlement).

Forebay

A forebay must be provided for all wet ponds that provides for sediment capture and ensures that flows into the overall pond are non-erosive. The sediment forebay is intended to capture only coarse sediments and is the location where most frequent sediment cleanout will be

¹²¹ New Zealand Transport Agency, 2010

¹²² NZSOLD, 2015

¹²³ NIWA, June 1995

needed because coarser particles comprise the highest proportion of incoming sediments in terms of total volume.

The forebay bund separating the forebay from the main body of the pond should be formed from impermeable material so that the water level in the forebay can be lowered for maintenance purposes. The crest of the forebay weir should be set to the permanent water level.

The forebay should meet the following criteria:

1. The volume of the forebay should be at least 15 % of the water quality volume (or 30% of the adjusted volume when extended detention is required). It should be cleaned out when filled in to about 50% of its design volume.
2. Flow velocities from the forebay during the 10-year ARI rainfall event must be less than 0.25 m/s, in order to avoid resuspension of sediment. In some cases this may necessitate increasing the size of the forebay above the minimum criteria provided above. The recommended depth of the forebay is 1 metre or more, to reduce velocities.

Hydraulic flow characteristics

1. Calculate the water quality volume to be treated using the water quality rainfall event, less the retained I_a (or lesser volume depending on site constraints).
2. Take a minimum of 50% of that volume for normal pool (dead) storage (when detention is required).
3. Use either the water quality volume or 1.2 times the water quality volume to determine the extended detention volume less the retained I_a (or lesser volume depending on the site constraints). The extended detention volume is then used to determine the depth of runoff that is to be stored and released over a 24 hour period.
4. Either conservatively assume that the entire extended detention volume is in the pond at one time even though this will not actually be the case since the outlet orifice will be sized to release this volume over a 24 hour duration. Or determine the extended detention volume storage requirement using routing. The steps below relate to the former method.
 - Use an elevation - storage table to estimate the elevation required to store the full extended detention volume
 - Calculate the average release rate (equal to the volume/duration) = Q_{ave}
 - At the full extended detention design elevation, the maximum release rate is assumed to be $Q_{max} = 2(Q_{ave})$
 - Calculate the required low flow orifice size: $Q_i = 0.62A(2gh_i)^{0.5}$ by trialing various orifice sizes.
 - h_i = elevation difference = the elevation at extended detention - the elevation at normal pool + $d/2$.

Other devices may be suitable for extended detention design, and all are based on a similar approach to the orifice opening approach. Those designs can include:

- Multiple orifices at the same elevation (n orifices, A area each)

$$Q_i = n \cdot 0.62A(2gh_i)^{0.5}$$

- Vertical slot extending to water surface (width w)

$$Q_i = 1.8 w h_i^{3/2}$$

- Vertically spaced orifices (situated h_1, h_a, h_b from surface of pond filled to the WQ volume. Each orifice area A)

$$Q = 0.62A(2gh_1)^{0.5} + 0.62A(2gh_a)^{0.5} + 0.62A(2gh_b)^{0.5}$$

- Pipe (area A) $h = (1.5Q_i^2/2gA^2) + h_f$

where h_f is pipe friction loss

Several different outlet designs for extended detention are detailed in Figure 8-26.

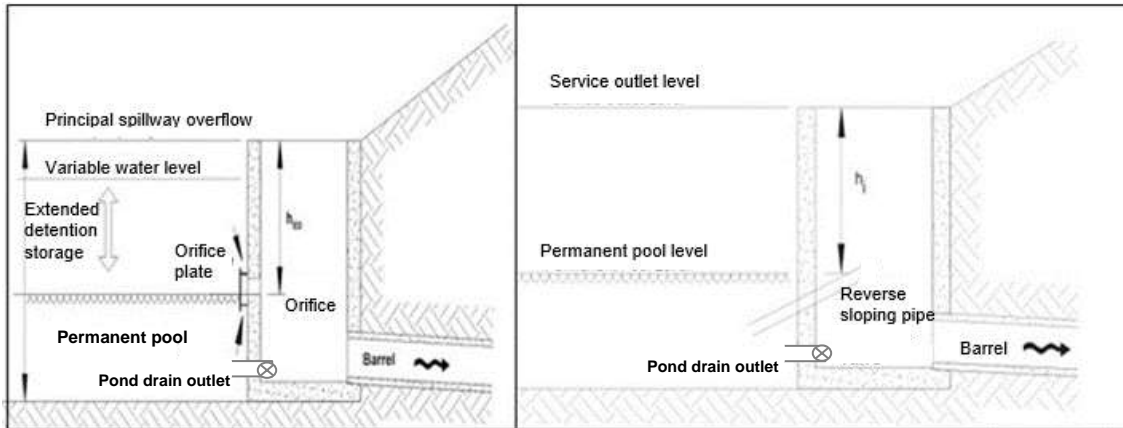

Figure 8-26: Schematic of extended detention outlet structures¹²¹

5. Intermediate storm: 2 and 10-year ARI event stormwater management

Set the invert elevation of the 2-year release point at the extended detention water surface elevation (based on the elevation - storage table mentioned in step 4).

The service outlet may consist of a drop inlet structure, a broad crested weir, a cascade weir or a weir leading to an open channel. As peak control requirements call for both 2 and 10-year ARI storms to be controlled, the discharge is clearly defined in terms of the following equations.

Drop inlet

For moderate flows, the top of the drop shaft acts as a circular sharp weir. For a circular drop inlet, the energy head above the weir lip, (h_{ii}) can be used to calculate the flow according to:

$$Q_{ii} = 3.6pR h_{ii}^{3/2}$$

Where R is the radius of the inlet.

For a box weir:

$$Q_{ii} = 7.0wh_{ii}^{3/2}$$

Where w is the length of the side of the square box, on the inside.

These equations apply only for $h_{ii}/R \leq 0.45$ (or, for a box inlet, $h_{ii}/w \leq 0.45$). For $h_{ii}/R > 0.45$, the weir becomes partly submerged, and for $h_{ii}/R > 1$ the inlet is fully submerged and the flow resistance is equal to the inlet resistance of a pipe, typically:

$$h_{ii} = k(v^2/2g)$$

Where v is the velocity at flow Q_{ii} and k is typically 0.5 to 1.0, depending on the details of the inlet

For a circular inlet:

$$v = Q_{ii}/pR^2$$

Starting with the design flow and the chosen pipe radius, the head (h_{ij}) can be found by using the appropriate formula for the h_{ij}/R value. If this head is higher than desired, a large outlet can be used.

Aeration of the flow over the weir should be considered if the flows are so high that inadequate ventilation may cause damage to the drop structure. In general, adequate ventilation will be provided by appropriate sizing of the outlet pipes. It is recommended that the outlet pipe be sized so that when the emergency spillway is operating at maximum flow (Q_v), the outlet discharges at 75% full. Standard pipe friction and pipe outlet loss calculations can be performed to determine the required outlet size¹²⁴.

The entry to the outlet should be protected by a screen or grid cage to collect debris.

Broad crested weir

In this case, a weir narrower than the emergency weir is used. The weir could be situated away from the emergency weir, or if sufficient erosion protection is provided, in a lowered section of the emergency spillway.

The flow may pass down a single chute into a small plunge pool or appropriately lined area. Alternatively, a series of small cascades or a stepped spillway may be used. To size the weir, the change in pond elevation (h_{ij}) at the service design flow is found by solution of the following equation:

$$Q_{ij} = 0.57(2g)^{1/2} (2/3Lh^{3/2} + 8/15zh^{5/2})$$

As an approximation, the following formula may be used for a broad-crested weir:

$$Q_{ij} = 1.7 L h_{ij}^{3/2}$$

Weir with channel

This design will be useful for shallower ponds, where the channel can be easily constructed by making a cut in the embankment.

The outflow is controlled by the weir. Appropriate texts may be consulted for refined weir calculations, but the following may be used as an approximation for a sharp-crested weir:

$$Q_{ij} = 1.8Lh_{ij}^{3/2}$$

Where Q_{ij} is the service design flow, h_{ij} is the head over the weir when the emergency spillway starts operation and L is the length of the weir. The outlet channel should be sufficiently large that the water level is below the water level (h_{ij}) at the service design flow (to avoid backwater effects). The channel may require covering for safety reasons.

6. Emergency spillway design

The emergency spillway section is normally designed as a trapezoidal channel whose sizing is based on trial and error to the following equation:

$$Q = 0.57(2g)^{1/2} (2/3Lh^{3/2} + 8/15Zh^{5/2})$$

Where:

Q = discharge through the spillway

L = horizontal bottom width of the spillway

h = depth of flow at design flow

Z = horizontal/vertical side slope (recommended to be 3)

¹²⁴ USBR, 1977

Designs to avoid short-circuiting

Dead zones and short-circuiting are undesirable because they reduce effective pond detention times. The flow path length must be at least twice the pond width, and preferably three times the width (but not much greater). The narrower the flow path, the greater the velocity and the less settling will occur. The designer should minimise dead zones and short-circuiting to improve the treatment performance of the pond.

Oil separation

Stormwater will, in most situations, contain oils and greases. Having an extended detention outlet similar to the reverse sloping pipe shown in Figure 8-26 will allow water to be discharged from below the surface and encourage volatilisation of the hydrocarbons on the surface.

Debris screens

Screens are used to trap rubbish and organic debris, which is unsightly, especially if trapped in vegetation. Screens should be used to protect extended detention outlets from clogging. Screens may be installed either at the inlet to the pond or at the outlet from the pond.

Ease of maintenance

Ease of maintenance must be considered as a site design component. Access to the stormwater management pond or wetland must be provided for in the design, and land area adjacent to the pond must be set aside for drying out of sediments removed from the pond when maintenance is performed. The land set aside for pond maintenance should be sized as follows:

1. The set aside area shall accommodate at least 10 percent of the stormwater management pond volume at a maximum depth of one metre, and
2. The slope of the set aside area shall not exceed 5 percent, and
3. The area and slope set aside may be modified if an alternative area or method of disposal is approved on a case-by-case basis.

8.5.6.6 Pond and site design

Pond shape

The design of pond shape should consider engineering constraints, design parameters to achieve treatment, and the existing topography. For a given catchment the design parameters include water volume, surface area, depth, water flow velocity and detention period. In addition, it is recommended that the length to width ratio be 3 horizontal to 1 vertical or greater to facilitate sedimentation. These parameters should be considered in light of the existing topography. Generally, a pond will look more natural and aesthetically pleasing if it is fitted into existing contours.

Pond contours

Pond contour profiles are critical to the design of a pond: they determine available storage, the range of plants that can be grown and the movement of water through the pond. The safety features of shallow slopes and reverse slopes will help provide areas suitable for a variety of plants.

Edge form

Edge form influences the appearance of a pond, increases the range of plant and wildlife habitats and has implications for pond maintenance. Edges can include sloping margins where water level fluctuations cause greater areas of wet soils. Generally, sloping margins require a more sophisticated management approach to ensure growth of plants. Areas of gradually varied wetness should be identified and specific planting strategies should be developed for these areas. Such gradually sloping areas can appear a more natural part of the landscape than steep banks, and they provide opportunities for a greater range of plants and habitat.

Islands

Islands, properly located, can be used to manipulate flow characteristics, to increase the distance that water travels and to help segregate first flush inflow from later flows within a storm event. They also increase the extent of planted margin and can provide a wildlife habitat that offers some protection from domestic animals or people, as well as offering additional aesthetic appeal.

8.5.6.7 Landscaping

Design of a stormwater pond system should ensure that the pond fits in with the surrounding landscape. General landscape design principles will apply. The area should develop a strong and definite theme or character. This might be generated from particular trees, or views from the site, topographical features, or the cultural character of the surrounding neighbourhood. The landscape design for the area will provide a setting for the pond so that the pond will appear a natural component of the overall setting.

8.5.6.8 Case study – Stormwater pond

Project Description

A 100 lot residential subdivision is being constructed. It is 7.5 hectares in size with no off-site drainage passing through it. It has gentle slopes and average imperviousness is expected to be 50%. Pre-development land use is pasture. The site drains into a stream channel so extended detention is a design component. There are no downstream flooding issues identified.

Hydrology

A summary of the calculations is provided in Table 8-14.

Table 8-14: Case study – stormwater pond summary table

Parameter	Pre-development	Post-development
Q ₂	0.13m ³ /s	0.32 m ³ /s
V ₂		1,728 m ³
Q ₁₀	0.25 m ³ /s	0.64 m ³ /s
V ₁₀		3,456 m ³
Water quality volume		984 m ³
ED volume (1.2 x WQV)		1,181 m ³

The key elements of the table are the pre-development peak discharges and post-development volumes using a temperature increase of 2.1°C assumption for post-development rainfall increase to account for climate change. The peak discharges cannot exceed the pre-development peak discharges but the volumes to be stored are the post-development ones.

The water quality volume was calculated to be 1,112 m³ but by retaining the initial abstraction the water quality volume is 984 m³. As the extended detention volume is determined by the water quality volume that volume is 1,181 m³. Soil rehabilitation of post-development pervious areas means that the initial abstraction does not have to be retained for those areas.

Pond Design

An essential component of pond design is knowing what the available storage is at the pond location. As such, it is important to develop a stage-storage relationship table to calculate the volumes versus depths for storage and discharge purposes.

For this site Table 8-15 reflects available site storage.

Table 8-15: Stage-storage relationships

Elevation	Available volume
51.5	0
52	500
53	1400
54	2900
55	5600
56	7500

As the pond will discharge 1.2 times the water quality volume over a 24 hour period, the permanent water quality volume can be reduced by 50%.

The adjusted water quality volume is 492 m³ and rises to elevation 52.

The sediment forebay must contain a volume of at least 30% of the adjusted water quality volume, so **the sediment forebay must contain 148 m³.**

The lowest outlet is the extended detention outlet, whose invert is set at a level that impounds the required permanent water quality storage (492 m³) and the live storage for extended detention (900 m³). In this case **the elevation of the extended detention volume and water quality volume (1,673 m³) is at elevation 53.2.**

The extended detention (ED) outlet is sized to release the extended detention volume (EDV) over a 24-hour period. The simplest way to do this is to assume the pond is holding the full EDV with the release rate being, in this example, the following:

$$Q_{ED} = 1181 \text{ m}^3/24 \text{ hours} = 0.01 \text{ m}^3/\text{s}$$

At the full EDV elevation, the maximum release rate is assumed to be $Q_{max} = 2Q_{ED}$

$$Q_{max} = 0.02 \text{ m}^3/\text{s}. \text{ The discharge through the ED outlet cannot exceed } 0.02 \text{ m}^3/\text{s} \text{ or the detention time will not meet the 24 hour requirement.}$$

Volume of storage savings can be realised if the extended detention volume is determined by routing flows through the pond.

Calculate the low flow orifice by assuming an orifice size and ensuring that the outlet discharge does not exceed Q_{max} .

$$Q = 0.62A(2gh)^{0.5} \text{ where } A = \text{area of ED orifice}$$

Try an orifice size of 100 mm diameter

Where $h = 53.2 - (52 + .05)$ where D is the ED outlet diameter $h = 1.17 \text{ m}$

$$Q = 0.62(0.00785)((2)(9.8)(1.15))^{0.5} = 0.023 \text{ m}^3/\text{s} \text{ which is too large.}$$

Try an orifice size of 90 mm.

$$Q = 0.019 \text{ which meets the design criteria.}$$

As the orifice size is greater than 50 mm, a cover plate or screen is not required to prevent clogging of the orifice but is still recommended.

ED orifice is 90 mm.

Consideration of 2 and 10-year ARI event control will consist of consideration of a rectangular weir to provide for the appropriate outflow rates. Peak outflows should not exceed the pre-development peak discharges which are 0.13 m³/s and 0.25 m³/s.

To size the weir we can ignore the outflow that occurs during the rainfall and size the weir so the entire runoff volume can be held with the outflow rate not exceeding the pre-development peak flows. Routing of flows through the pond is also acceptable for this calculation but not for determining the ED volume sizing.

2-year ARI event

Pond volume required for the post-development case = 492 (WQ vol.) + 1,728 (2-year post-development volume) = 2,220 m³

Ponded water level is at 53.5 m.

Outflow must be determined using the ED orifice and an outlet structure (rectangular weir).

Weir invert level is at elevation 52.8 m.

Outflow from ED orifice = $Q = 0.62A(2gh)^{0.5}$

$$h = 53.5 - (52 + 0.09/2) = 1.45 \text{ m}$$

$$Q_{ED} = 0.62(.0063)((28.42))^{0.5} = 0.02 \text{ m}^3/\text{s from ED orifice.}$$

Outflow over weir = $Q = 1.7 Lh$ where L = weir width

$$\text{Try } L = 220 \text{ mm}$$

$$Q = 1.7(.225)(0.3) = 0.11 \text{ m}^3/\text{s}$$

Total outflow = ED + 2-year discharges = 0.02 + 0.11 = 0.13 m³/s which meets the 2-year peak control requirement.

So 2-year weir width = 220 mm

10-year ARI event

Pond volume required for the post-development case = 492 (WQ vol.) + 3,456 (10-year post-development volume) = 4715 m³

Ponded water level is at elevation 54.3 m.

Outflow must be determined using the ED orifice and the 2-year weir control.

Outflow from ED orifice = $Q = 0.62A(2gh)^{0.5}$

$$H = 54.6 - (52 + 0.09/2) = 2.55 \text{ m}$$

$$Q_{ED} = 0.62(.0063)((49.98))^{0.5} = 0.027 \text{ m}^3/\text{s from ED orifice.}$$

$$Q_{ED} = 0.027 \text{ m}^3/\text{s}$$

$$\text{2-year weir flow} = 1.7Lh = 1.7(.220)(1.1) = 0.41 \text{ m}^3/\text{s.}$$

Total peak discharge using 2-year weir and ED orifice = 0.41 + 0.027 = 0.44m³/s which exceeds the 10-year maximum discharge criteria (0.25 m³/s). There is little difference between the extended detention requirement and the 2-year peak control rainfalls so the 2-year weir can be fairly large (220 mm) and meet the 2-year peak control requirement. The 10-year rainfall is considerably larger and the elevational difference in storage means that the 2-year weir width must be decreased to meet the 2-year peak control requirements. The advantage is that a weir having a width of 130 mm will control the 2 and 10-year storms.

So, the design has an extended detention orifice of 90 mm and a broad crested weir having a width of 130 mm to provide control of all three storms.

8.5.7 Wetlands



<p>Description: Wetlands can be designed to provide:</p> <ul style="list-style-type: none"> • Water quality treatment • Extended detention, and • Peak flow control. <p>Treatment is provided through:</p> <ul style="list-style-type: none"> • Sedimentation • Filtration • Adsorption, and • Biological uptake 	<p>Stormwater Management Function</p> <table> <tr> <td data-bbox="783 741 858 797">✓</td> <td data-bbox="970 741 1155 864"> Water quality ✓ Metals ✓ Sediment ✓ TPH </td> </tr> <tr> <td data-bbox="783 875 858 931">✓</td> <td data-bbox="970 891 1155 925">Flood protection</td> </tr> <tr> <td data-bbox="783 965 858 1021">✓</td> <td data-bbox="970 969 1246 1025">Stream channel erosion protection</td> </tr> </table>	✓	Water quality ✓ Metals ✓ Sediment ✓ TPH	✓	Flood protection	✓	Stream channel erosion protection
✓	Water quality ✓ Metals ✓ Sediment ✓ TPH						
✓	Flood protection						
✓	Stream channel erosion protection						

Constructed wetlands are complex natural water environments that are dominated by hydrophytic (water loving) vegetation. They contain a very active organic component (made up of plants and microbes) that act to remove, metabolise or inactivate pollutants. A constructed wetland has a designed bathymetry and specific planting to provide water quality treatment and flow attenuation. They differ from stormwater wet ponds that are dominated by large areas of open water with no vegetation.

Until recently, the filling and draining of natural wetlands was accepted practice to “improve” land. We now know that wetlands provide many important benefits including the attenuation of flood flows, maintenance of water quality and support aquatic and terrestrial ecological values. The creation of constructed wetlands in urban areas to manage stormwater helps to reintroduce natural areas into the urban landform.

Constructed wetlands have become increasingly popular in recent years for providing water quality treatment. Wetlands can also be designed to accomplish a number of objectives including the following¹²⁵:

- Flood protection
- Flow attenuation
- Water quality treatment
- Cultural values
- Landscape values
- Recreational amenity function, and
- Provision of aquatic and terrestrial wildlife habitat.

¹²⁵ Wong et al, 1998

From a contaminant removal perspective, wetlands provide a number of different removal processes that are not available in deeper wet ponds. Those removal processes are listed in Table 8-16.

Table 8-16: Stormwater contaminant removal mechanisms of constructed wetlands¹²⁶

Contaminant	Removal Processes
Organic matter	Biological degradation, sedimentation, microbial uptake
Organic contaminants	Adsorption, volatilisation, photosynthesis and biotic/abiotic (pesticides) degradation
Suspended solids	Sedimentation, filtration
Nitrogen	Sedimentation, nitrification/denitrification, microbial uptake, plant uptake, volatilisation
Phosphorus	Sedimentation, filtration, adsorption, plant and microbial uptake
Pathogens	Natural die-off, sedimentation, filtration, predation, UV degradation, adsorption
Heavy metals	Sedimentation, adsorption, plant uptake

A key benefit of a stormwater wetland is its shallow nature. The shallow nature promotes dense vegetation growth that acts as a natural barrier to small children or the general public. Being shallow water systems, they do not have the safety concerns that deeper ponds have. Fewer safety concerns are an important consideration in selecting wetlands for water quality treatment. Two types of wetlands will be discussed in this section: constructed wetlands and wetland swales.

The design of wetlands is complex and impacted by site and outcome considerations. The guidance in this document provides minimum design considerations but does not provide detailed design componentry. Wetlands should be designed by suitably qualified and experienced professionals with a strong understanding of the desired outcomes for that site.

8.5.7.1 Basic design parameters

It is important to specify the contaminants that a constructed wetland is designed to treat, as effective treatment of different contaminants can require markedly different detention times within the wetland.

Suspended solids are at one end of the treatment spectrum and require a relatively short detention time to achieve a high degree of removal. At the other end of the treatment spectrum are the nutrients: nitrogen and phosphorus. Given sufficient area and time, wetlands are capable of achieving high levels of nutrient removal but their efficiency for nutrient removal depends on their design, and in particular providing adequate residence time.

The most common design priority for constructed wetlands in the Waikato Region is the removal of:

- Sediments,
- Hydrocarbons,
- Dissolved metals, and
- Nutrients.

Hydrology is the single most important criterion for determining the success of a constructed wetland as it dictates the health of the wetland vegetation. They should therefore only be used in areas that have enough inflow from rain, upstream runoff or groundwater to ensure the long-term viability of wetland processes.

¹²⁶ Mitchell, 1996

Site considerations for the design of wetlands include the following:

Table 8-17: Site considerations for wetlands¹⁰⁶

Catchment	Catchment areas should be at least 2 hectares in size (as stated in Table 6-7). Wetlands should be sized based on the entire contributing catchment
Geotechnical investigations	Geotechnical investigations are required to inform all wetland designs
Soil type	Wetland are most suited where insitu soils are silty to clay
Off-line	Wetlands should be designed to be off-line to open watercourses in greenfield development
Base flow	Wetlands need to receive adequate baseflow / water inputs to maintain the health of wetland vegetation. Some permeability can be designed for where groundwater recharge / retention is required as long as it does not impact vegetation health.
Location	Wetlands should be placed away from slopes or locations where there are slope stability issues. Wetlands should be designed with appropriate setbacks from dwellings, property lines, retaining walls, structures and traffic areas. Wetlands should not be located on or near contaminated land or fill materials.
Pre-treatment	Pre-treatment is recommended to reduce the long term maintenance costs of wetlands.
Maintenance	Adequate space is required for access for operation and maintenance functions to be performed around the wetland – to all pre-treatment areas and the main body of the wetland and the inlet and outlet structures. Regular maintenance is required to remove gross pollutants and to remove sediment build up from wetland forebays.

Design parameters for wetlands are the same as the parameters for wet ponds in the context of storm peak control and stream channel erosion control. So the same design procedures need to be followed. There is some difference in the design of a constructed wetland when compared to a wet pond, which are discussed below.

Wetland design considerations and parameters include the following:

Table 8-18: Design considerations for wetlands¹⁰⁶

Wetland shape	Should be designed to promote flows that use the full width of the wetland and that avoid short circuiting Length to width ratio to be at least 3L:1W
Inlets	Inlets need to be located within a forebay bund to capture gross sediments in the forebay and to enable flows to be dispersed into the main body, avoiding short circuiting. Debris screens should be considered to be used for safety and to remove rubbish and prevent clogging. Erosion protection should be provided at the discharge point for inlets (rock rip rap on a geotextile layer). The invert of the inlet should be no lower than the designed permanent water level of the wetland. A high flow bypass should form part of the inlet structure, diverting non-design flows upstream of the forebay with erosion protection.
Outlets	The service outlet incorporates specific outlets at different levels sized to achieve the required design criteria for the site.

	<p>The outlet riser should incorporate the specific outlets, a top debris screen and a valve/screw cap located close to the wetland base level to allow for dewatering of the wetland for maintenance.</p> <p>The outlet pipe which discharges downstream must be correctly sized. If discharging to a coastal area, stream, lake or wetland, erosion protection must be provided.</p> <p>A removable weir plate should be included in the outlet arrangement (within an accessible manhole) that allows the permanent water level to be adjusted for maintenance.</p> <p>Anti-seepage solutions must be provided along outlet pipes.</p>
Forebay	<p>To hold a minimum of 15% of the water quality volume</p> <p>Minimum depth is 1.5m.</p> <p>The base of the forebay should be lower than the main body of the wetland. The base should be hardened for easier maintenance. A vertical depth marker should be included to assess sediment build up.</p> <p>Flow velocities from the forebay to be less than 0.25m/s during a 10 year ARI event.</p> <p>Forebay bund is to be accessible for maintenance.</p> <p>A submerged impermeable bund is recommended (crest level 100-150mm below the permanent water level) to delineate the forebay from the main body of the wetland but to provide a constant depth. The forebay bund ends should be keyed into the side slopes.</p>
Slopes	<p>All slopes must be approved by a geotechnical engineer based on site-specific constraints.</p>
Wetland safety bench	<p>Is to be provided at least 3m wide around the entire wetland (no more than 300mm below the permanent water level), densely planted to form a natural barrier.</p>
Emergency spillway	<p>Should be armoured and ideally located in natural ground. The spillway embankment should be carefully compacted during construction to prevent settlement.</p> <p>Where possible locate near the inlet to the wetland to minimise resuspension of sediments in large storm events.</p> <p>Invert should be 100mm above the maximum water level in the wetland.</p> <p>Freeboard should be at least 300mm above the maximum peak flow of the design storm event.</p>
Maintenance access	<p>An access track is to be provided that is a minimum of 3.5m width and adequate slope to provide ease of access.</p> <p>A sediment drying area is required near the forebay (sized to accommodate 10% of the permanent water volume at 1m depth), located away from the wetland banks, flat with vehicle access.</p>
High flow bypass	<p>It is recommended that a high flow bypass and maintenance bypass is included in the design.</p> <p>High flow bypasses should be designed to:</p> <ul style="list-style-type: none"> • Withstand high flows without erosion and scour. • Preferably to be above ground, e.g. a vegetated trapezoidal channel. • Take into account downstream conveyance capacity constraints.

Planting	<p>At least 80% of the wetland zone is to be densely planted (excluding the forebay area) at a minimum density of 4 plants / m². Wetland plant suggestions are provided in Table 8-18 below.</p> <p>Suitable plant selection is critical for wetland success. Plant species should be tolerant to the required ranges of depth, frequency and duration of inundation.</p> <p>Taller marsh species should be selected within deep marsh zones. Initial planting densities in deep marsh zones should be higher than in shallow marsh zones, so hydraulic resistance is similar between shallow and deep areas.</p> <p>Vegetation that provides a high level of shading (trees, shrubs and reeds/tall sedges) should be planted around, and within, the wetted margin of the wetland.</p>
Flow velocities	Flow velocities in the wetland must not exceed 0.1 m/s for up to the 2 year ARI event and 0.5 m/s for larger storms.
Fish passage	Should be included in the design where appropriate.

Constructed wetlands must be designed in accordance with:

- New Zealand Society of Large Dams (NZSOLD), Dam Safety Guidelines, 2018
- NZSOLD, Guideline on Inspecting Small Dams, 1997
- New Zealand Building Act, 2004.

Bathymetry

Constructed wetlands are shallow vegetated water bodies that do not contain large volumes of water per surface area when compared to wet ponds.

Constructed wetlands are to be designed to have banded bathymetry, as illustrated in Figure 8-27 below. Banded bathymetry, in long section, has variable depths with alternating deep and shallow marsh sections interspersed with occasional open water areas. It is assumed that water spreads evenly across the full width of the wetland as a uniform flow.

A banded bathymetric design is preferred for having variable depth that allows for dispersed flow of stormwater through vegetation and has deeper areas for fish, which will assist in preventing mosquito problems.

The proposed depth ranges and areas for a vegetated wetland having a banded bathymetric design are the following:

<i>Banded bathymetric design</i>	<u>% total wetland pool area</u>
Dead storage 0.35 -1.0 m depth	40
Dead storage at 0 – 0.35 m depth	60

The banded bathymetric design is recommended due to its configuration providing a reasonable expectation of uniform flow throughout the wetland.

No areas of a wetland other than the sediment forebay should be deeper than 1 metre.

Water quality volumes

As Table 8-16 lists the variety of removal processes that wetlands use to remove contaminants, sedimentation is only one of those processes with the others relying on contact between stormwater contaminants and plants and organic matter. As can be seen from Figure 8-27, wetlands are shallow water systems and rely more on surface area than on having a specific volume of storage.

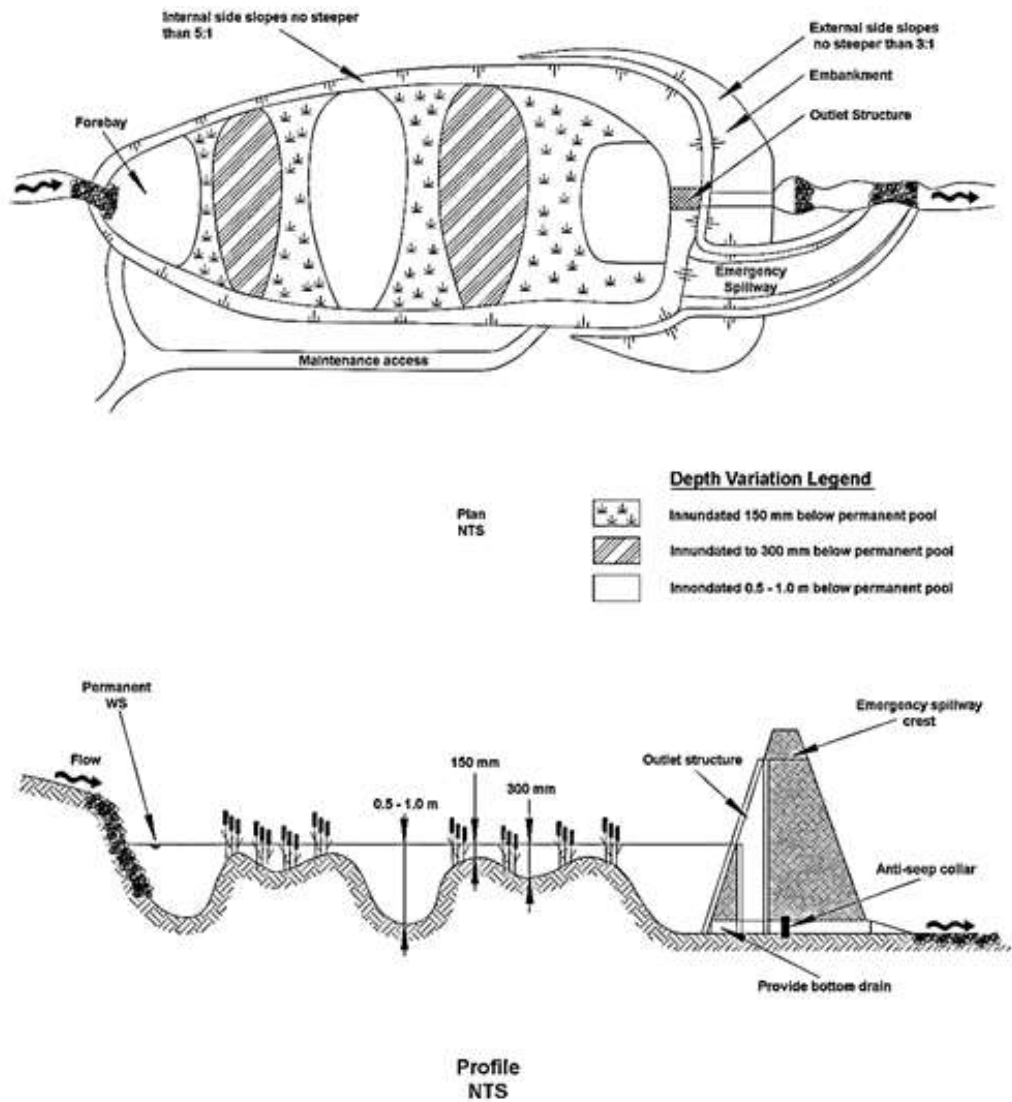

Figure 8-27: Banded bathymetric wetland schematic¹²⁷

There are several approaches to considering a surface area requirement. The first approach is to use the wetland surface area as a proportion of the catchment area and a recent publication¹²⁸ recommends a ratio of wetland area to catchment area of 3%. In a similar fashion a report out of Australia¹²⁹ relates hydrologic effectiveness to wetlands having a surface area as a percentage of catchment area and indicates a desirable ratio of approximately 2% for a catchment of 30% imperviousness and a 72 hour detention time for nitrogen reduction.

Another approach is to relate hydrologic effectiveness to wetland storage as a percentage of annual runoff volume. The same report¹²⁹ shows a “knee” point of approximately 2% where benefits start to wane for further increases in storage. Again, this design is based on the removal of nutrients as a key objective.

The ratios in both publications relate to nutrient capture and may be considered appropriate where stormwater runoff is discharged to lakes, but in general the broader range of contaminants of concern in the Waikato Region are sediments, metals (lead, copper, zinc) and nutrients may result in a variety of sizes and detention.

As a result, the recommended approach for wetland design is to be conservative and have the surface area of the wetland at the permanent water level as 3% of the overall catchment area draining to the wetland when imperviousness of the contributing catchment is less than or equal

¹²⁷ Auckland Regional Council, 2003 as modified

¹²⁸ Capiella et al, 2008

¹²⁹ Wong et al, 1999

to 70%. Once imperviousness exceeds 70% the surface area requirement increases to 4% of the overall catchment area.

Soils

An important element of wetland function is the need to maintain hydric conditions for wetland plants. As such, a soils analysis of the invert of the wetland shall be undertaken to ensure that the wetland area will retain water. The following points discuss this issue.

- Looking over the NIWA climate report for Waikato, evapotranspiration is at its greatest in January with the Thames area and Taupo having the highest rates. If maximum rates are considered rather than the average ones it comes out to about 5 mm per day, which is a fitting conservative value to use.
- A number of values for permeability rates and incorporated evapotranspiration were considered with the result being a value of 0.05 $\mu\text{m/s}$ being a reasonable value. This value would give a daily rate of 4.3 mm and when maximum evapotranspiration is included the result is approximately 9.3 mm/day reduction in water level surface.
- The average inter-event dry periods for various locations in the Waikato region are approximately 5 days during the summer months. Using 0.05 $\mu\text{m/s}$ as the permeability rate would mean that a wetland having an approximate depth of 300 mm would take approximately 32 days to lose its standing water.
- This value assumes no reduction in permeability due to deposition of sediments and organic matter to the wetland base that would further reduce permeability. It assumes the maximum evapotranspiration rates for the full 32 days. Considering the evapotranspiration rates, there is a considerable drop in that maximum rate outside of the month of January.

It is recommended that when designing a constructed wetland, if the soil permeability rate is less than or equal to 0.05 $\mu\text{m/s}$ then a liner/impermeable layer is not required in the base of the wetland. If the permeability rate is greater than 0.05 $\mu\text{m/s}$ then a liner/impermeable layer is required to achieve the maximum permeability of 0.05 $\mu\text{m/s}$.

Where a liner is used in a wetland, a minimum depth of 300mm of soil (or greater depending on what is suitable for the selected wetland vegetation) is required above the liner to ensure vegetation has enough soil to grow in.

Groundwater levels

If a constructed wetland is proposed in an area with known high groundwater levels, the groundwater level can be taken into account when considering the need for a liner/impermeable layer in the base of the wetland, regardless of the soil permeability. If the groundwater level, at the lowest level during the year, is above the base of the wetland then the soil analysis is not of great importance as evapotranspiration will not lower the water level in the wetland. In those situations, a liner/impermeable layer is not necessary even in permeable soils to maintain wetland vegetation. However if groundwater levels are high, consideration will need to be made to the impact of groundwater on storage/detention volumes in the constructed wetland.

The key requirement when using groundwater to establish the wetland permanent pool is to provide groundwater monitoring wells in the wetland location and monitor groundwater levels as per the following criteria.

Depth to groundwater at the location of a proposed **impermeable/lined constructed wetland** is to be determined through groundwater level monitoring for a minimum of **3 readings** over a period of **3-4 months (August to November)** sufficient to assess the winter high groundwater level, at a minimum of 1 groundwater monitoring well/piezometer location.

Depth to groundwater at the location of a proposed **unlined constructed wetland** is to be determined through groundwater level monitoring for a minimum of **monthly readings** over **12 months** at a minimum of 1 groundwater monitoring well/piezometer location.

Monitoring wells should be of a suitable depth and construction to monitor the near-surface groundwater table only (e.g. screened response zone 2-5m below ground level).

If the year is abnormally wet or dry then the monitoring discussed above should be repeated the following year to provide assurance that permanent groundwater levels are understood. The longer the time period of monitoring, the greater the assurance of maintaining hydric conditions in the wetland.

Where there is a Catchment Management Plan (CMP) for the area in question, it is expected that the CMP will provide further information about groundwater levels in the catchment.

The difference in the above requirements relates to whether the wetland is proposed to have an impermeable layer or not. If the wetland is to have an impermeable layer, the winter high groundwater level is critical to understand in terms of potential impacts on wetland performance (impact on storage/detention volumes). If the wetland isn't to have an impermeable layer then ideally the full range of groundwater levels needs to be understood in terms of both the impacts of groundwater on storage/detention volumes during winter high groundwater levels, and drawdown and associated effects on vegetation during summer low groundwater levels.

High flow bypass

Wetlands can be designed to provide flow attenuation (including stream protection and flood control). However, flow velocities must be managed to reduce the risk of resuspension of captured sediments and associated pollutants, prevent scour of biofilms and to protect plants. The wetland should be designed to protect vegetated areas from damage and resuspension of settled sediments during high flows.

Wetlands should be designed with a high flow bypass where possible to protect wetland vegetation from damage during large rainfall events. The bypass should divert high flows upstream of the forebay. Where this isn't possible, the bypass should divert flows upstream of the main wetland body (from within the forebay, as close to the inlet as possible).

Wetlands in series

It is not recommended that wetlands be provided in series due to steepness of slopes in a catchment, as per what can be designed for if using ponds (refer Section 8.5.6.3). Wetlands have level water surfaces and rely on dense vegetation to provide for water quality treatment. It is generally not possible to increase the surface area of wetlands where adjacent slopes are steep.

8.5.7.2 Detailed design procedure

The design basis for a stormwater wetland is twofold:

- Water quality objectives are achieved by sizing the wetland surface area to 3% of the catchment drainage area draining to the wetland for sites having imperviousness less than 70% of the site area. Where imperviousness exceeds 70% then the wetland surface area must be at least 4% of the catchment area. The wetland depths are then provided through the relative depths provided in the above depth discussion.
- Intermediate storm control and extended detention objectives are met through the same calculations discussed in the wet pond Section that include reductions in storage volume due to retention of the initial abstraction.
- Situations where there is no requirement for extended detention must consider velocities through the wetland such that biological function is not adversely impacted. In those situations, the maximum velocity of stormwater through the wetland shall not exceed 0.1 m/s for up to the 2 year ARI event and 0.5 m/s for larger storm events. Where extended detention is required there is no need for velocity reduction consideration as the 24 hour discharge time period ensures low velocities.
- Forebay design is identical to the design detailed in Section 8.5.6.5.

The design steps are the following:

1. Calculate the wetland surface area as at least 3% of the contributing catchment area. Once imperviousness exceeds 70% the surface area requirement increases to 4% of the overall catchment area.
2. The shape of the wetland should be designed to promote flows that utilise the full width of the wetland. The length of the wetland should be at least three times its width. This criteria can be relaxed if extended detention is required as flows will be significantly reduced and the length to width ratio is not as important.
3. Using the depth discussion above ensure that the percentage of wetland depths meet the above criteria with a banded bathymetric design.
4. Calculate the water quality volume that the wetland would have in an identical approach to the wet pond water quality volume. Take 15% of that volume as the necessary volume of a sediment forebay. The surface area determined from this approach can reduce the wetland surface area, as the two areas together can meet the 3% (or 4%) criteria.
5. Determine whether the project needs peak flow control and stream channel erosion control through extended detention.
6. Do calculations identical to the wet pond design for extended detention release sizing and outlet sizing for the 2 and 10-year ARI event.

The following table provides a list of plant species for general consideration for use in wetlands. Plants for a given project should be considered for suitability by an appropriately skilled practitioner. It is essential that selected plants are very tolerant of wet and dry conditions.

Table 8-19: Vegetation suitable for wetlands

Deep zone: 0.6 – 1.1m Baumea articulata Eleocharis sphacelata Schoenoplectus validus	Typha orientalis (raupo) Myriophyllum propinquum (water milfoil) Potamogeton cheesemanii (manihi)
Shallow zone: 0.3-0.6m Baumea articulata Bolboschoenus fluviatilis Eleocharis sphacelata Eleocharis acuta Carex secta	Schoenoplectus validus Typha orientalis Isolepis prolifer Juncus gregiflorus
Wet margin: 0-0.3m Baumea teretifolia Baumea rubiginosa Carex secta Eleocharis acuta	Juncus gregiflorus Carex virgate Cyperus ustulatus (giant umbrella sedge) Phormium tenax (flax)
Live storage zone (periodically inundated) Syzygium maire (swamp maire) Carex virgata Carex lessoniana (rautahi) Carex dissita (flat leaved sedge) Cyperus ustulatus Juncus articulatus Juncus pallidus	Dacrycarpus dacrydioides (kahikatea) Cordyline australis (cabbage tree) Baumea rubiginosa Phormium tenax (flax) Coprosma tenuicaulis (swamp coprosma) Blechnum novae-zelandiae (swamp kiokio)
Land edge: Coprosma robusta (karamu) Phormium tenax Cordyline australis Carpodetus serratus (putaputa weta) Laurelia novae-zelandiae (pukatea) Leptospermum scoparium (manuka)	Schefflera digitata (pate) Melicytus ramiflorus (mahoe) Pneumatopteris pennigera (gully fern) Dacrycarpus dacrydioides (kahikatea) Cortaderia fulvida (toetoe)

8.5.7.3 Wetland swale design

Wetland swales consist of broad open channels in areas where slopes are slight, water tables are high or, on a seasonal basis, there is base flow, and there are saturated soil conditions. If soil is saturated for more than two weeks, normal grasses will not grow.

Wetland swales are similar to normal constructed wetlands in their use of vegetation to treat stormwater runoff. The wetland swale acts similarly to a long and linear shallow wetland treatment practice. Figure 8-28 shows a typical cross-section for a wetland swale.

Design considerations

There are two separate approaches that can be used for sizing wetland swales.

- Storage of the water quality volume generated by the upstream catchment, or
- Ensuring wetland swale residence times exceed 9 minutes.

For the purposes of this guideline, the recommended approach is ensuring residence times exceed 9 minutes. As the wetland swale will, for the most part, have water in it with standing vegetation, the vegetation may not be as dense as vegetation in a normal vegetated swale. This will result in using a Manning's roughness coefficient of 0.1.

As a result, wetland swales will either be longer or wider than normal vegetated swales. There are several key design elements to a wetland swale.

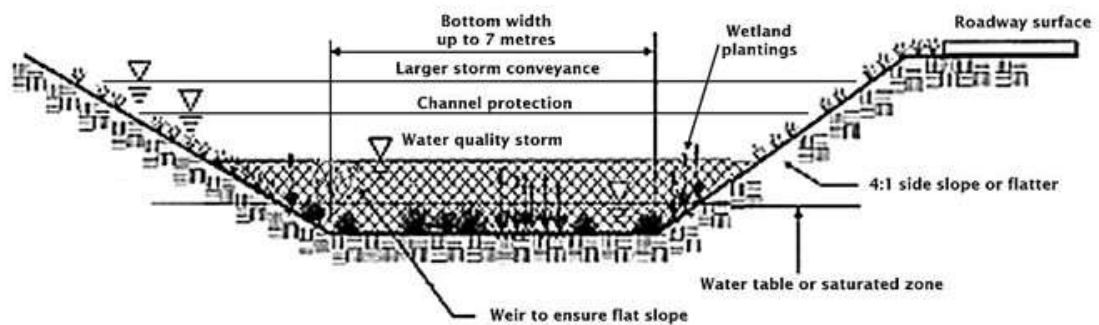

Figure 8-28: Cross-section of a wetland swale¹³⁰

- As there is no concern about wider channels concentrating flow at one point (as in normal swales), a wetland swale can be up to 7 metres wide.
- Due to a reduced roughness coefficient, a length to width ratio of 5 horizontal: 1 vertical should be provided.
- If there is a longitudinal slope, check dams must be used to manage the flow, ensure a level bottom on the wetland swale and maintain very shallow side slopes.
- If the wetland swale relies on groundwater to maintain hydric soils, groundwater monitoring shall be undertaken as discussed in Section 8.5.7.1.
- If the wetland swale is to use bunds to maintain water levels, liners shall be required to eliminate seepage.

A schematic of a wetland swale with check dams is shown in Figure 8-29. Even though there is a longitudinal slope, the check dams ensure a level invert elevation.

¹³⁰ Adapted from Center for Watershed Protection, 2001

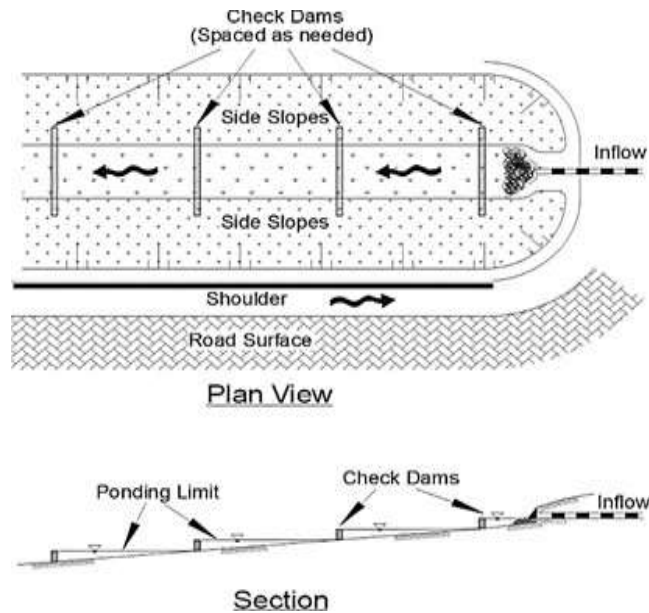

Figure 8-29: Longitudinal slope on a wetland swale¹³¹

Targeted contaminants

Wetland swales are effective at removing suspended sediments and metals. They provide a moderate removal of nutrients and are less effective at removal of oil and grease.

Advantages

Wetland swales can have the following advantages.

- Having an outlet structure for the wetland swale can provide for peak flow control and extended detention,
- They can accentuate the natural landscape,
- Contaminant removal efficiency can be improved over a normally dry swale, and
- They enhance biological diversity and create beneficial habitat between upland areas and streams.

Wetland swale showing check dams prior to placement of soil and plants



¹³¹ Auckland Regional Council, 2003

Same wetland swale post-construction



Limitations

Wetland swales are not practical in areas of steep topography and are not practical when driveway crossings are required unless significant opening areas are provided.

Design sizing

The design approach takes the designer through a series of steps that consider swale performance for water quality treatment and consideration of larger flows to ensure that scour or resuspension of deposited sediments does not occur.

1. Estimate runoff flow rate from the water quality storm using 1/3 of the 2-year storm as the water quality storm and calculate the flows. Wetland swales are designed by flow rate as discussed in Section 8.5.1.
2. Design should use the Waikato Stormwater Runoff Modelling Guideline.
3. Establish the longitudinal slope of the wetland swale. The maximum slope (with or without check dams) should be less than 2%.
4. Select wetland vegetation cover. Types of wetland vegetation to recommend are detailed in Table 8-19 above.
5. The value for Manning's coefficient of roughness for wetland swales is 0.10.
6. Select a swale shape. Two shapes are proposed as they ensure distributed flow throughout the bottom of the swale. Of the two shapes, the trapezoidal shape is recommended. Channel geometry and equations for calculating cross-sectional areas and hydraulic radius are provided under the individual configurations in Figure 8-30.
7. An assumption is made on the normal pool and live storage depth of flow for the water quality storm. This assumed depth is used for calculating the bottom width of the wetland swale and cross-sectional area.
8. It is not necessary to have a normal pool elevation for a wetland swale but it is important to have a saturated subgrade for wetland plants to thrive. If it can be documented that groundwater is at the surface for the entire year, then a wetland swale is very appropriate.
9. Use Manning's equation for calculating dimensions of the swale by using first approximations for the hydraulic radius and dimensions for selected shape.

$$Q = AR^{0.67}s^{0.5}/n$$

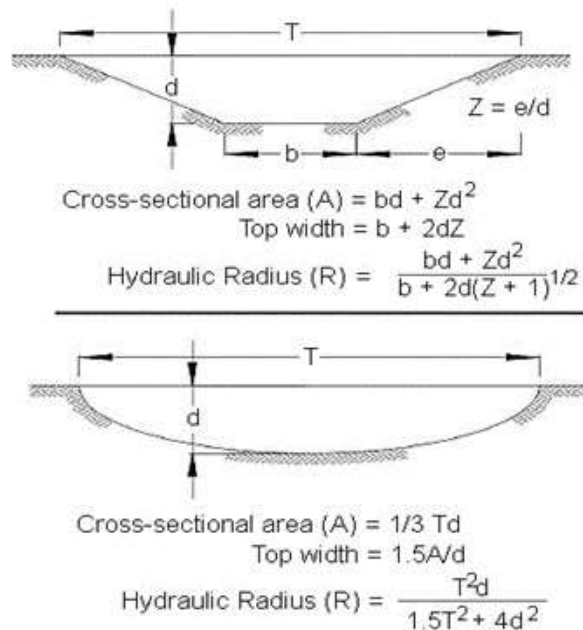

Figure 8-30: Channel geometry¹³¹

By making some assumptions about depth and width ratios such as the hydraulic radius for a trapezoid approximating the depth (d), the bottom width of a trapezoid (b) equals the following:

$$b = (Qn/d^{1.67}s^{0.5}) - Zd$$

The slope, depth, discharge and side slope are all known and b can be determined.

Where:

Q = Design discharge flow rate (m³/s)

n = Manning's n (dimensionless)

s = Longitudinal slope (m/m)

A = Cross-sectional area (m²)

R = Hydraulic radius (m)

T = Top width of trapezoid/parabolic shape (m)

d = Depth of flow (m)

b = Bottom width of trapezoid (m)

For a parabola, the depth and discharge are known so the top width can be solved for.

Knowing b (trapezoid) or T (parabola), the cross-sectional area can be determined by the equations in Figure 8-32.

Calculate the swale velocity from the following equation:

$$V = Q/A$$

If $V > 0.8$ m/s repeat steps 1 - 9 until the velocity is less than 0.8 m/s.

11. Calculate the swale length (L in metres)

$$L = Vt \text{ (60 s/minute)}$$

Where t = residence time in minutes.

Flows in excess of the water quality storm

It is expected that runoff from events larger than the water quality design storm will go through the wetland swale. In that situation, a stability check should be performed to ensure that the 10-year 1-hour storm does not cause erosion. For the 10-year storm, flow velocities should not exceed 1.5 m/s, although higher velocities may be designed for with appropriate erosion

protection. Post-development rainfall should include an allowance for climate change, refer to Section 7.1.6 for details.

If extended detention and/or peak flow control is a requirement for a specific project, the outlet of the wetland swale can be modified so that storage volumes are provided.

8.5.7.4 Case study – Wetland swale

Project description

An access road, driveways and pasture for a 3 lot rural subdivision is proposed to drain to a wetland swale. The lane is 6.4 metres wide and 400 metres long, the three driveways are each 3.4 metres wide and 75 metres long and the pasture area is approximately 10,000 m².

Hydrology

Pre-development land use is pasture on a 2% - 7% slope.

A = catchment area in hectares = 1.33 ha.

$$Q_{wq} = 0.04 \text{ m}^3/\text{s}$$

$$Q_{10} = 0.1 \text{ m}^3/\text{s}$$

Swale Design

Slope of swale alignment = 0.02

Several assumptions have to be made regarding the swale, first of which is that the wetland swale will have a trapezoidal design. Side slopes (Z) will then be recommended and an assumption of design storm depth should be made. That value may change depending on the velocity of flow being less than 0.8 m/s.

For this case study, Z = 4 and the depth of flow = 100 mm. The static water level (or dead storage) in the wetland swale is estimated to be 100 mm deep as check dams have been designed to maintain a level bottom, but that storage cannot be considered in terms of flow velocities. Since storm flow will overtop the check dams, the slope to use in calculations is the longitudinal slope and not permanent water elevation slope.

Based on the value for Q and s, and the assumptions for n and d, solve for the swale bottom width (b).

$$b = (Qn/d^{1.67}s^{0.5}) - Zd$$

$$b = ((.04)(.1)/(.1^{1.67})(.02^{0.5})) - (4)(.1) = 0.97 \text{ m}$$

Calculate the top width

$$T = b + 2dZ = 0.97 + 2(.1)(4) = 1.77 \text{ m}$$

Calculate the cross-sectional area

$$A = bd + Zd^2 = (0.97)(.1) + 4(.1^2) = 0.137 \text{ m}^2$$

Calculate the flow velocity

$$V = Q/A = 0.04/0.137 = 0.3 \text{ m/s which is well under than the 0.8 m/s maximum - good.}$$

Calculate the wetland swale length

$$L = Vt = 0.3(540 \text{ sec.}) = 162 \text{ metres long}$$

The wetland swale length can be reduced significantly if it were made wider. A wetland swale can have a bottom width up to 7 metres as standing water will not cause flow to concentrate in one area. As an example, if the swale bottom width were increased to 3 metres, the following calculations will provide an adjusted length.

$$b = 3 \text{ metres}$$

$$T = 3 + 2(.1)(4) = 3.8 \text{ m}$$

$$A = 0.34 \text{ m}^2$$

$$V = Q/A = 0.04/0.34 = 0.11 \text{ m/s}$$

$$L = 0.11(540) = 59.4 \text{ m (150 m less length than the previously calculated length)}$$

As the swale will probably have larger flows pass through it, the swale design can be adjusted to account for the larger flows. In this situation the Manning coefficient of roughness will not have to be decreased as wetlands vegetation is expected to be considerably higher than the static water level, so assume $n = .1$. Solve for d and ensure that velocities are not erosive. $Q_{10} = 0.06 \text{ m}^3/\text{s}$.

$$b = (Qn/d^{1.67}s^{0.5}) - Zd$$

$$0.97 = (0.1(.1)/d^{1.67}s^{0.5}) - 4d$$

by trial and error, the wetland swale must have a depth of 200 mm to convey the 10-year storm

$$A = bd + Zd^2 = (0.97)(.2) + 4(.2)^2 = 0.35 \text{ m}^2$$

$Q = AV$ or $Q/A = V = 0.1 \text{ m}^3/\text{s}/0.35 = 0.28 \text{ m/s}$ so the velocities during the 10-year storm are non-erosive.

8.5.7.5 Case study – Wetland pond

The case study is the same case study as the wet pond design but designing a wetland instead.

Project description

The same development as designed in the wet pond section is proposed but using a wetland pond. It is 7.5 hectares in size with no off-site drainage passing through it. It has gentle slopes and average imperviousness is expected to be 50%. Pre-development land use is pasture. The site drains into a stream channel so extended detention is a design component.

The total catchment area is 7.5 hectares and the soils are typical clay soils. Pre-development adjacent land use is pasture and the site drains to the upper part of a stream:

- Peak flow control of the 2- and 10-year storms
- Extended detention of 1.2 x WQ storm
- Water quality treatment

The following is from the wet pond case study.

Table 8-20: Wetland case study - summary table

Parameter	Pre-development	Post-development
Q_2	0.13m ³ /s	0.32 m ³ /s
V_2		1,728 m ³
Q_{10}	0.25 m ³ /s	0.64 m ³ /s
V_{10}		3,456 m ³
Water quality volume		984 m ³
ED volume (1.2 x WQ *V)		1,181 m ³

Wetland design

1. Water quality Volume = 984 m³ and the wetland forebay must be 15% of the water quality volume.

Sediment forebay size is 148 m³

The surface area of the wetland will be 3% of the contributing catchment area, which is 7.5 hectares.

Wetland surface area is 2,250 m²

Since extended detention is a design requirement, the length to width ratio is not as important but for this case study a length to width ratio would provide a general shape of approximately 30 metres wide by 80 metres long.

To have the depths defined we use the relationships provided above.

<u>Banded bathymetric design</u>	<u>% total wetland pool area</u>	<u>Areal Extent (m²)</u>
Dead storage 0.5 -1.0 m depth	40	900
Dead storage at 0 – 0.5 m depth	60	1350

The forebay volume can be taken from the deeper dead storage so if the forebay is 1.5 m deep, the surface area is 98 m² so the dead storage for other areas of the wetland deeper than 0.5 m = 502 m².

Figure 8-31 shows this visually.

As the forebay elevation is considered part of the wetland surface area, the areas detailed in the banded bathymetric design have been reduced proportionally to account for the forebay area. If the individual areas are added together the total recommended levels are achieved.

2. Extended detention design and peak storm control are undertaken identically as the wet pond design detailed design procedure. They are not replicated here but are detailed in the Wet Pond case study section under the Extended Detention and 2- and 10-year sections of the case study.

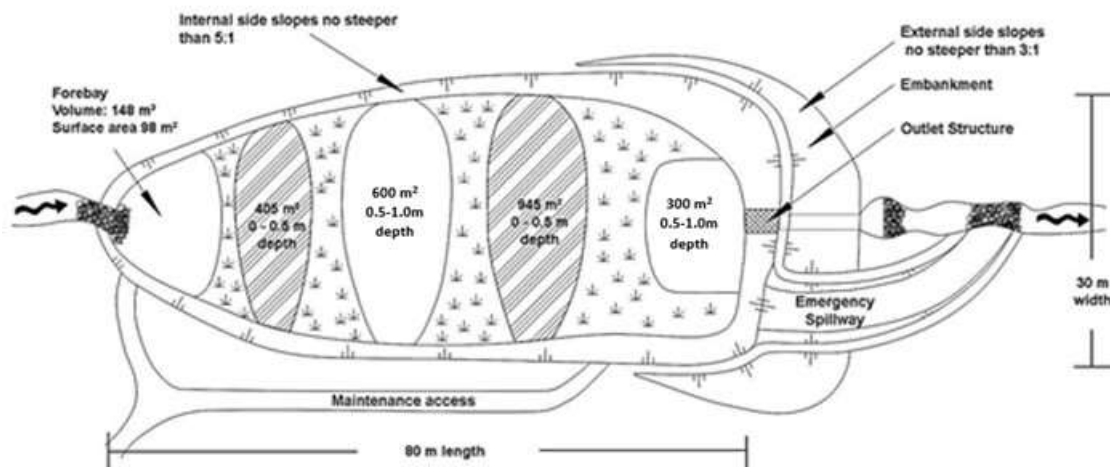

Figure 8-31: Wetland case study – percentage areas¹³²

¹³² Adapted from Auckland Regional Council, 2003

8.5.8 Green roofs



<p>Description: Green roofs are roofs with a growing media that reduces stormwater runoff through evaporation and evapotranspiration. Their primary benefit from a stormwater management perspective is to reduce the total volume of stormwater runoff.</p>	Stormwater Management Function	
	<input checked="" type="checkbox"/>	Water quality <input checked="" type="checkbox"/> Metals <input checked="" type="checkbox"/> Sediment
	<input type="checkbox"/>	Flood protection
	<input checked="" type="checkbox"/>	Stream channel erosion protection

Green roofs are roof systems that incorporate a growing media and plants to provide a semi-permeable surface on roofs that would normally consist of impervious surfaces. A green roof more mimics a natural environment to filter precipitation through the media and allowing for the wetted media to evapotranspire between storm events. A green roof may eliminate runoff during small rainfall events and will retard the onset of stormwater runoff and increase the time of concentration from a conventional roof, thus reducing downstream stormwater effects.

8.5.8.1 Design considerations

The figure below illustrates typical green roof components which include the following:

- A waterproof membrane to prevent water from leaking into the structure
- A drainage layer to allow lateral movement of water to the down spout
- Filter media for passage of stormwater and a growth media for plants
- Mulch or other material to prevent surface wind and rain erosion, and
- Plants.

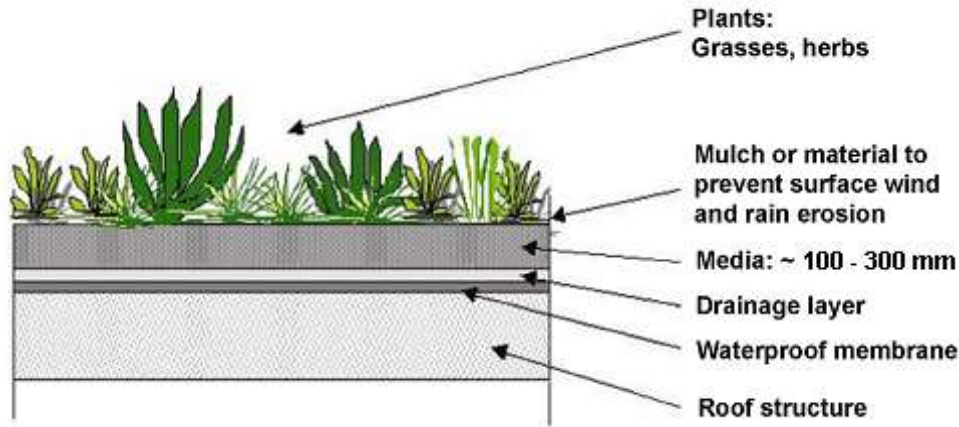

Figure 8-32: Green roof cross-section showing components¹³³

Green roofs are engineered systems, which address all of the critical aspects of design, including the following:

- The saturated weight of the system and load bearing capacity of the underlying roof
- Moisture and root penetration resistance through use of a waterproof membrane,
- Resistance to wind shear, management of drainage
- Vertical drainage features, and
- The suitability of the proposed plant material.

There are generally considered to be two types of green roofs.

- Extensive green roofs, which are shallow systems having less than 100 mm of media, which are not being advocated by this toolbox, and
- Intensive green roofs, which are deeper systems having more than 150 mm of media.

8.5.8.2 Targeted contaminants

From a water quality perspective, green roofs would be effective in retention of fine, wind-blown sediments and dissolved metals.

8.5.8.3 Advantages

Overseas data indicates that green roofs can be very effective at reducing the total volume of stormwater runoff. A study in North Carolina¹³⁴ indicated that a green roof retained 45% of total annual runoff. Monitoring undertaken by the former Auckland Regional Council at the University of Auckland Engineering Building green roof indicated the following:

- Depth of media between 50 – 70 mm
- 83 storms were monitored over 13 months
- 87% average reduction in peak flow rate
- 68% of rainfall doesn't become runoff, and
- 80% retention for storms less than 25 mm of rainfall.

Green roofs can be used on a variety of roof types and on any property size, as their installation will not require the use of additional land. In the Waikato Region's temperate climate, green roofs should not be limited by the ability to establish and maintain vegetative cover.

¹³³ Auckland Regional Council, 2003

¹³⁴ Moran et al, 2005

Another key advantage of green roofs is that they are aesthetically pleasing. They can be very attractive. There are also benefits related to urban cooling during the summer months and insulation benefits for air conditioning and heating.

8.5.8.4 Limitations

There are several issues that may be considered as limitations:

- Green roofs, as recommended in this Guideline, will necessitate increased structural strength of the roof that would increase costs.
- Maintenance needs, while expected to be minimal, may be costly and difficult depending on height above ground. Also related to this is the need to provide safety features for access to the roof for maintenance
- Establishment of plants and their overall survival may require watering during dry periods, at least for the first several years.
- Weed removal may be a requirement depending on individual conditions.

8.5.8.5 Design sizing

There are several key elements of design that need to be addressed.

- Depth of media
- Composition of media
- Any mechanical building services on the roof must be designed around
- Plant selection
- Additional support consideration
- Roof slope
- Drainage layer and impermeable liner, and
- Stormwater management benefits.

8.5.8.6 Depth of media

There are two green roofs in the Auckland Region that are being studied for water quantity and quality benefits: the University of Auckland Engineering Building green roof, and the Waitakere City Council Headquarters building green roof.

While these are more recent installations, some guidance can be given on plant propagation that relates to the depth of media. The University of Auckland site has media between 50 mm - 70 mm in depth. Over the 2007-2008 summers, plants were severely stressed due to the lack of moisture in the shallow subgrade. The Waitakere City green roof fared much better due to its depth being 70 - 150 mm.

Green roof at Waitakere City Council building

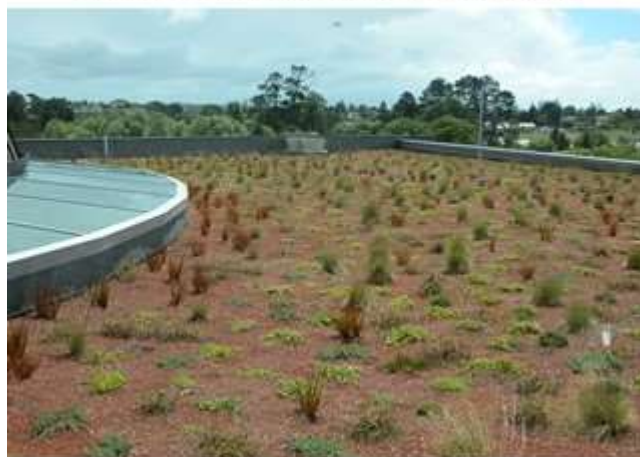

Deeper media depths are better than shallower ones.

It is recommended that there be at least 150 mm of media to promote a sustainable plant community.

8.5.8.7 Composition of media

The University of Auckland site investigated a number of different media and has found that the mixture of the following provides the best results and that mixture is recommended for use.

- 30% zeolite,
- 50% pumice, and
- 20% composted bark.

The mixture should be blended together with gentle tumbling with the maximum moisture content of 15%. Mixing when the mixture is too wet or too dry will compromise various aspects of the roof function. Approximately 20% extra mixture should be blended than needed to account for consolidation and losses.

8.5.8.8 Plant selection

New Zealand does not have any native succulents, which is the plant of choice internationally due to their ability to thrive in both wet and dry conditions. There are New Zealand plants that are suitable for green roofs, especially with the recommended depth of media being at least 150 mm.

Recommended plants include the following:

- *Disphyma australe* (NZ ice plant)
- *Pimelea prostrata* (NZ daphne)
- *Libertia peregrinans* (NZ Iris)
- *Festuca coxii* (native tussock)
- *Comprosa Hawera*
- *Acaena microphylla* (NZ bidibid)
- *Lepostigma setulosa* Other plants will be acceptable, but a plant specialist should be consulted prior to use due to the shallow media depths and the extremes of wetting and drying that will be encountered. In addition, the plants must be selected to survive conditions that can be more stressful than ground-level landscaping and have minimal maintenance needs.

8.5.8.9 Additional support consideration

The additional load of materials comprising the various components and an assumption of having saturated media conditions needs to be considered when accommodating the roof's structural load. The calculation has to be based on an assumption of a saturated state.

A chartered Professional Engineer must be consulted in the design and construction of a green roof system.

8.5.8.10 Roof slope

Generally, the construction effort and cost of green roofing increases with slope. Minimal slopes slow down water flow and slopes above 5° will have more rapid runoff. Due to native plants not providing the density of vegetation that would bind the media, it is recommended that green roof slopes not exceed 5° unless steps are taken to prevent media slippage and erosion.

8.5.8.11 Drainage layer and impermeable liner

The drainage layer should be a Delta NP drainage layer, or equivalent, with a non-woven geotextile, which is a two-layer drainage and waterproofing system with the cloth facing the media. The layer should be tested using ASTM E2398 – 11 Standard Test Method for Water

Capture and Media Retention of Geocomposite Drain Layers for Green Roof Systems, and ASTM E2396 – 11 Standard Test Method for Saturated Water Permeability of Granular Drainage Media (Falling – Head Method) for Green Roof Systems.

The impermeable liner should be Permathene flexible polypropylene geomembrane (250 um), or equivalent.

Both of these products can be substituted for if the substitution meets the same standards as the two presented.

8.5.8.12 Stormwater management benefits

Green roofs provide an excellent media for water quality treatment of any airborne contaminants and thus meet water quality treatment guidelines.

The media recommended includes zeolite, which is a hydrated aluminosilicate mineral having a micro-porous structure. Pumice also has a very high porosity and being highly porous is very lightweight. Design can assume a 50% void ratio for the compost bark, zeolite and pumice.

Stormwater quantity control is not required for green roofs.

8.5.8.13 Case study – Green roof

A typical green roof design is shown in the figure below.

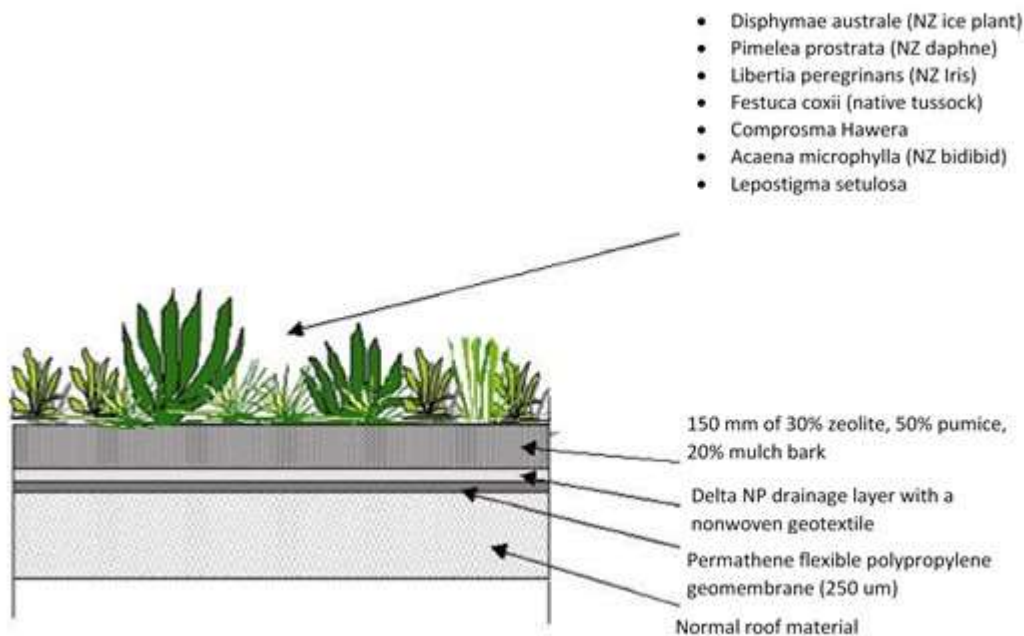

Figure 8-33: Case study parameters for a green roof¹³³

8.5.9 Bush revegetation



<p>Description: Bush revegetation reduces site runoff by providing leaf canopy interception, evapotranspiration and soakage into the organic ground cover:</p> <ul style="list-style-type: none"> • Evapotranspiration • Soakage • Flow retardance 	Stormwater Management Function	
	<input checked="" type="checkbox"/>	Water quality <input checked="" type="checkbox"/> Metals <input checked="" type="checkbox"/> Sediment
	<input type="checkbox"/>	Flood protection
	<input checked="" type="checkbox"/>	Stream channel erosion protection

Relating to land use, stormwater runoff is greatest from impervious surfaces. Less runoff is generated from pasturelands. Native bush that is protected from grazing and having litter and brush covering the ground generates the least amount of stormwater runoff.

When land is being converted from rural to residential, commercial or industrial land use the total volume and peak rate of stormwater runoff are increased. As pastureland has a greater volume of stormwater runoff than does bush, conversion of existing pastureland into bush can reduce future runoff and mitigate for the effects of increased impervious surface generation.

8.5.9.1 Design considerations

The approach is based on extent of area that is set aside for re-establishment of bush. Key considerations related to re-establishment are the following:

- Existing areas of bush that can be extended
- Natural site features
- Slope, and
- Location of waterways.

Providing additional bush to existing bush areas would increase the value of existing bush by increasing bush interior areas. This would reduce fringe vegetation that could become a weed maintenance problem.

When sizing bush restoration for various lot sizes, the level of imperviousness will be very important. As lot size reduces from 1 hectare to 2,000 m², the proportion of the site that is impervious may limit area required for bush establishment. Under an assumption of a 1 ha lot having 600 m² of imperviousness; it will take 3500 m² of bush to compensate for that impervious surface. If a lot is 0.5 ha and the imperviousness of the lot remains at 600 m² the amount of bush to compensate for the impervious surface is still 3,500 m² but that will represent approximately 70% of the site area rather than 35%.

If the site area goes below 0.5 ha bush cannot compensate for 600 m² of imperviousness.

The approach can be used on a subdivision or catchment wide basis, where area can be set aside, converted to bush and overall subdivision or catchment stormwater runoff reduced. It is not only an individual site practice. Revegetation does not have to totally mitigate for impervious surfaces but it can reduce stormwater runoff increases and reduce the amount of work that other devices have to accomplish to minimise adverse impacts.

Bush planted as a riparian corridor in a residential subdivision



8.5.9.2 Targeted contaminants

While native bush vegetation having a good ground cover can provide contaminant reduction benefits, its main purpose is the reduction of stormwater runoff volumes. Organic matter on the bush floor will remove metals and assist in removal of sediments but residential land use in rural areas does not generate large contaminant loads. Commercial and industrial land use may increase contaminant loads but other devices provided in the guidelines would provide greater levels of treatment.

8.5.9.3 Advantages

Native bush grows over time and maintenance concerns diminish. Where other stormwater management devices need maintenance to ensure long-term performance, bush revegetation improves its hydrological function over time and maintenance obligations become minimal.

Native bush also provides benefits for wildlife habitat, shading and cooling during summer. It can act as a windbreak and can be an aesthetic amenity.

8.5.9.4 Limitations

Native bush planting can have fairly high maintenance needs during the first 2-3 years of growth relating to weed control and possible watering needs during drought conditions.

Native bush can also be seen as limiting site usage. If some livestock were a desired activity on the site, they must be excluded from access to the bush areas to ensure that bush growth is not adversely affected.

When planted in widths of less than 20 metres, weeding can remain a problem for years.

8.5.9.5 Design sizing

Bush re-establishment is based on the following Table 8-21.

Table 8-21: Bush planting requirements

Proposed site impervious area (m ²)	Area of bush required (m ²)
100	1,000
200	1,500
300	2,000
400	2,500
500	3,000
600	3,500

The calculations, using an annual runoff spreadsheet approach that calculates storm and base flow under various landuse scenarios¹³⁵ work out to be fairly consistent. For every 100 m² of imperviousness beyond the first 100 m² of imperviousness there is a 500 m² requirement for bush establishment.

Recognising the significant areal extent of bush replacement, it may be best to isolate various impervious surfaces and address them separately. That would allow for several devices to provide site management without using too much of a given portion of the site to any one practice.

8.5.9.6 Case study – Bush revegetation

A house on 1 hectare is being constructed and the footprint for the house and driveway is 550 m² of imperviousness. The site, as shown in Figure 8-34, has a house, driveway, septic system and needs 3,250 m² to compensate for impervious surfaces.

Since the roof of the house has a water tank that was designed as in the water tank design section then the 250 m² can be excluded from the bush revegetation approach. In that case, the impervious surface is now 290 m² so the bush replacement area is now 1,950 m², which is a significantly reduced area.

Using devices in conjunction with one another can significantly reduce the size of a device if it is used to address all of the areas.

¹³⁵ Beca Carter Hollings & Ferner, 2000

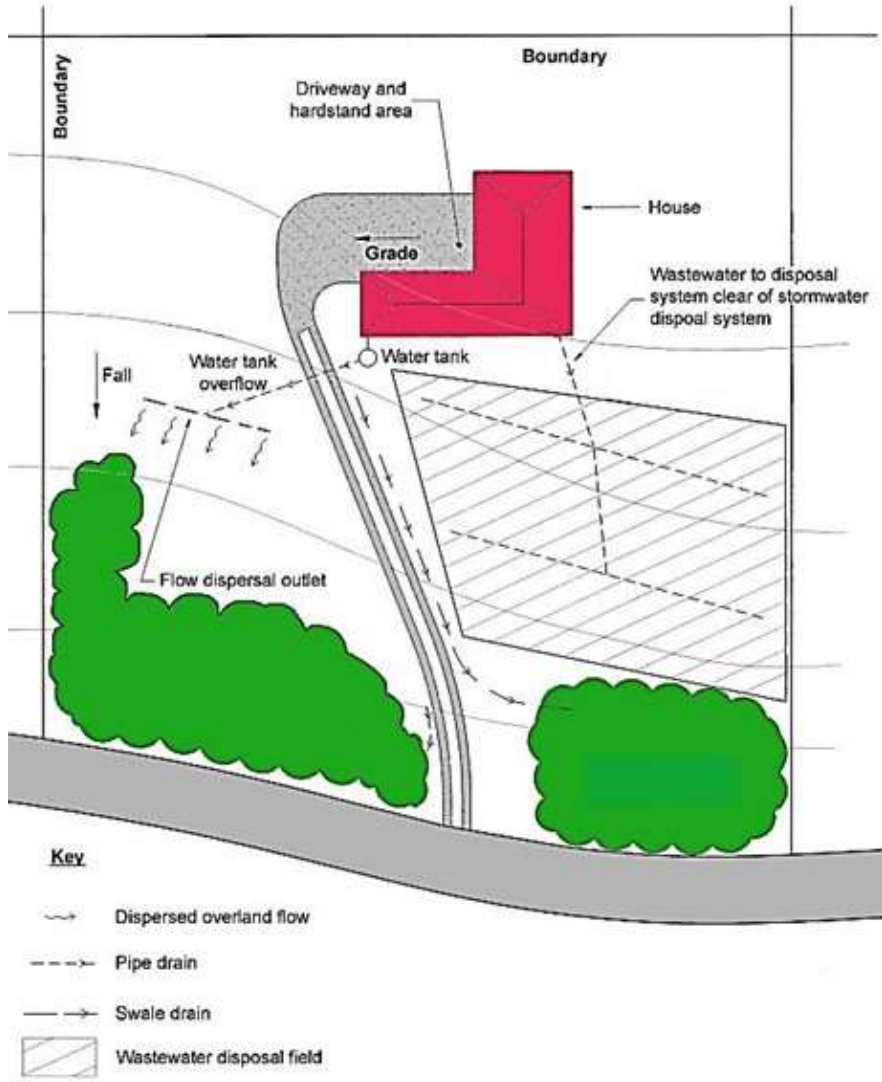

Figure 8-34: Bush revegetation for runoff control¹³⁶

¹³⁶ Bay of Plenty Regional Council, 2012

8.5.10 Water tanks



<p>Description: Water tanks provide detention storage for stormwater runoff and water supply for domestic use. They reduce stormwater runoff through domestic use and thus reduce the total volume of stormwater being discharged during a storm event.</p>	Stormwater Management Function	
	<input checked="" type="checkbox"/>	Water quality <input checked="" type="checkbox"/> Metals <input checked="" type="checkbox"/> Sediment
	<input type="checkbox"/>	Flood protection
	<input checked="" type="checkbox"/>	Stream channel erosion protection

A water tank is a storage receptacle for stormwater runoff that is generated from roof areas. The stored water can then be used for site needs.

The primary function of water tanks in a rural area is to provide water supply for residential, commercial and industrial use. In addition to the water supply benefits water tanks also reduce the total volume of stormwater runoff by redirecting the runoff to a storage tank for subsequent use for site water needs.

The primary function of water tanks in an urban area is to augment water supply for residential, commercial and industrial use. In addition to the water supply benefits water tanks also reduce the total volume of stormwater runoff by redirecting the runoff to a storage tank for subsequent use for site water needs. In an urban environment there are a number of benefits to using a water tank:

- Cost savings depending on size and water use
- Good management of natural resources
- Delayed investment in new Council infrastructure
- Reduced volume and peak flow of stormwater runoff entering streams and harbours, and
- Reduced possibility of sewer overflows.

It is recognised that in many situations the water tank may be the only source of water for a given site. As such, the tank water will be used for potable purposes. This can involve several health and safety related issues including treating and disinfecting the roof runoff to meet appropriate water quality standards. It is suggested that professional assistance be solicited in these situations. For more information it is suggested that a copy of the Ministry of Health's "Household Water Supply"¹³⁷ document be read.

¹³⁷ <https://www.health.govt.nz/resource/household-water-supplies>

If rainwater is being used for indoor purposes, it is likely that rainwater will need to be supplemented by Council mains supply to guarantee a regular supply. There are two options for doing this:

- Topping up the tank from mains into the top of the tank. This requires an appropriate air gap between the tank and top up pipework.
- Direct connection to mains water top up. This requires a testable backflow prevention device and local water suppliers must be contacted to discuss the requirements.

Any outdoor taps must have signage with the wording “Rainwater – Not for Drinking” as per the Building Act. For more information it is suggested that a copy of the Ministry of Health’s “Household Water Supply” document be read.

A local council building consent may be required for installation of a water tank.

8.5.10.1 Design considerations

There are a number of elements that need to be considered when designing a water tank.

- The annual average rainfall amount and inter-event dry periods
- The roof area
- The anticipated water use
- The percent of water from the roof that can be used
- Peak flow considerations, and
- Sizing outlets.

It is assumed that water tanks, in the context of this Guideline, will be both full service tanks and, where water supply is provided by local council, limited to non-potable uses.

It is not intended in this Guideline that roof areas compensate for impervious surfaces beyond the roof area itself.

8.5.10.2 Targeted contaminants

For the most part, rainfall in the region is not contaminated. The major source of contamination may be from the roof materials themselves or from animal or plant organic matter. Contamination issues can be minimised by using roofing materials that don’t generate contaminants or by screening gutters for minimising the entry of organic matter.

8.5.10.3 Advantages

Water tanks have several advantages.

- They reduce the total volume of stormwater runoff by separating the site water use from stormwater runoff
- They provide for site water use in areas where groundwater supply may be limited, and
- Through storage and use, they can provide for detention of excess flows and reduce downstream effects.

Water tanks require minimal maintenance if filtering of roof runoff is provided through screens or first flush diverters.

8.5.10.4 Limitations

The most obvious limitation of water tanks is the potential for them to run dry during drought times, which could occur. This issue can be minimised through provision of excess storage that ensures adequate capacity during drought times. In addition during extreme drought, water can be purchased to fill the tank.

Where water tanks are the only means of providing domestic water (residential use), the minimum tank size shall be 25,000 litres. This value is based on needing storage for domestic

water reuse, live storage for temporary attenuation of detained roof runoff and a wastage factor.

8.5.10.5 Design sizing

As mentioned in Section 8.5.10.2, there is a logical progression of analysis that needs to be undertaken for water tank sizing.

The average annual rainfall amount and the inter-event dry periods

Average annual rainfall in the region is variable as shown in Figure 8-35. When using water tanks for domestic or industrial site use, it is essential to have a good understanding of the annual rainfall to ensure that water needs are met.

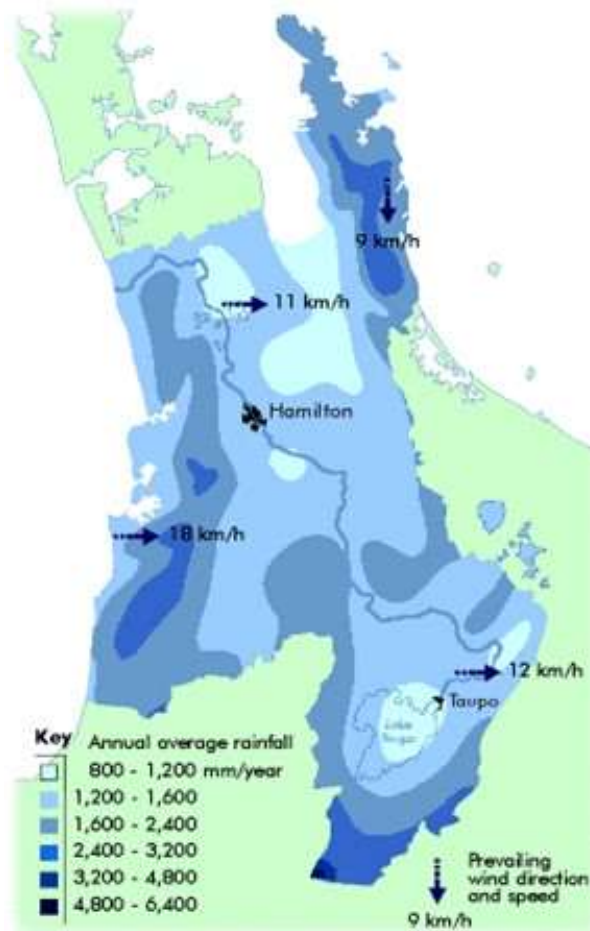

Figure 8-35: Annual rainfall throughout the region¹³⁸

In terms of providing storage for rain water usage it is important to understand the period of time during the year when it doesn't rain, as tank storage will have to account for those dry times. This is considered the inter-event dry period and that time period will vary during the year. Figure 7-3 provides the inter-event dry periods and shows the variation from month to month for the region.

Inter-event dry periods are important to consider if the water is being used for domestic or industrial use. During periods of dry weather additional water is not available so storage must be provided for those expected dry periods.

Although there is only several days' difference in the inter-event dry period between winter and summer there is some seasonal difference with the average dry period in January through March being approximately 5 days. That means that the volume of storage needs to be provided for the daily-anticipated water usage multiplied by at least 5 to provide for needs during the dry periods. It must be recognised that the 5 is an average value and additional storage would provide longer-term protection. The maximum period of time could be as long as two weeks if

¹³⁸ <https://www.waikatoregion.govt.nz/community/about-the-waikato-region/our-climate/>

water tanks are the sole source of water. If tank water is the sole source of domestic water, it is recommended that 10 days be used as an inter-event dry period to design tank storage for.

How much water can be captured from the roof

The first aspect of design is to calculate the roof area that will be drained to a water tank. Figure 8-36 details how that is done. The area that is green and covers the whole plane of the green area is the roof area that is then used in calculations.

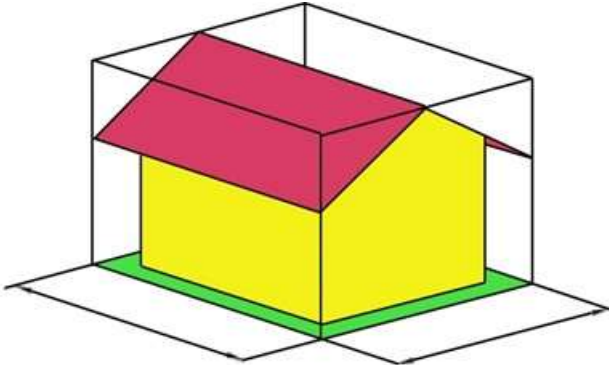

When calculating catchment area, measure at ground level below edges of the roof, including eaves

Figure 8-36: Calculation of roof surface areas

Another component of roof runoff capture is what percentage of stormwater that runs off the roof can be used depending on roof area, tank size, daily usage and whether there are detention requirements associated with roof imperviousness.

The anticipated water use

Table 8-22 provides information on anticipated water use for residential properties. This water demand is based on 500 litres/day for a three member household. The values can be extrapolated for more or less members but an average assumption of three members is reasonable given the potential of people relocating. It is recommended that water use for a residence be 325 litres/day for non-potable use.

Table 8-22: Estimated residential water demand for a 3 member household

Water use	Average litres/day
Bathroom	125
Toilet	125
Laundry	100
Gardening	100
Kitchen	50
Total	500

The same assumption cannot be made for rural commercial or industrial land use. In this situation, assumptions need to be made regarding the number of people that will occupy the workplace. Table 8-23 provides information on occupancy ratios.

Table 8-23: Building occupancy ratios for different activities¹³⁹

Activity	Floor to Person Ratio
Office	25 m ²
Showroom	35 m ²
Warehouse	50 m ²
Shops, retail	35 m ²
Restaurant/dining areas	15 m ²
Local shopping centres	35 m ²
Manufacturing	25 m ²

The number of individuals occupying the building will be the gross floor area divided by the floor to person ratio.

The amount of office water used per day is the number of individuals times 25 litres/day. At a minimum the value should total 125 litres/day.

Industrial sites will have to be considered on an individual basis as the industrial usage may require water use in its operation. The total expected amount of use will then be based on employee and operations usage.

The percent of water from the roof that can be used

There will be periods of time when the water tank is full due to longer periods of wet weather. The concern related to this situation is when detention storage is required for peak discharge control. It is not an issue for domestic or business use as more water does not present a problem related to consumption.

As a guide to collection capacity, consider that each **1mm of rain = 1 Litre (L) of water per square metre (m²)** of roof area, then allow a 15% wastage factor. This will allow for a good understanding of whether the roof can provide the needed amount of water that is needed.

As an example, 1,250 mm of rainfall on a 200 m² roof would result in 250,000 litres/year – 37,500 litres (wastage) = 212,500 available litres for site use. If partial site usage was 325 litres/day then having an adequately sized water tank could provide for 100% of site usage while reducing stormwater runoff. If all of the water is captured, the water tank would also supply 100% of needed water for full service use by a three person household.

The 15% wastage factor accounts for the time of year that the tank overflows due to rainfall exceeding tank storage.

Peak flow consideration

When sizing a water tank, there are two possible storage components.

- The water needs component, and
- An attenuation volume that reduces peak rate of discharge.

The attenuation volume occupies the upper storage area of the tank with its outlet orifice placed immediately above the water needs volume as shown in Figure 8-37.

¹³⁹ North Shore City Council, 2008

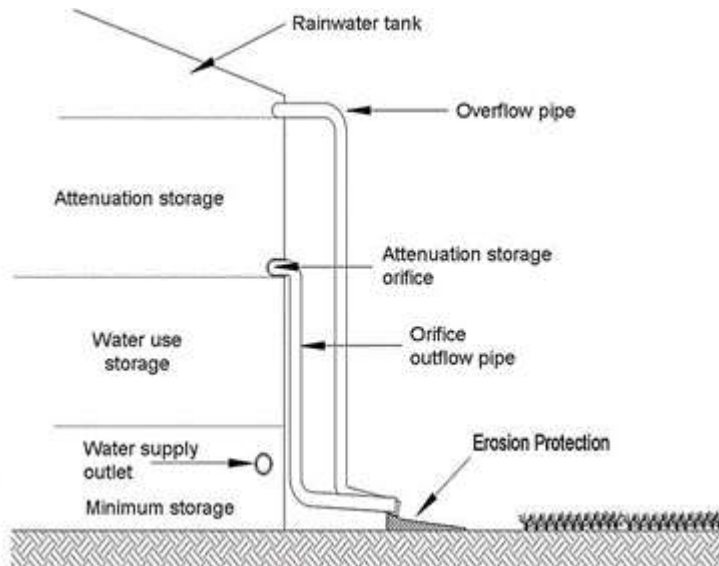

Figure 8-37: Combination attenuation and water use tank¹⁴⁰

It is possible that the combined storage would provide more benefit than is estimated. A higher level of attenuation may be achieved in some instances when the tank water level is lower than the orifice level at the start of the storm. These benefits are very difficult to estimate and are not taken into account in design.

There will be a portion of the year when roof runoff will exceed water use and runoff during that time needs to be considered in terms of attenuation.

Providing detention storage for the water quality storm provides additional storage to the domestic use volume to further reduce potential impacts to downstream channel erosion. The volumes for detention tank storage are provided in Figure 8-38. This detention volume is in addition to the domestic use volume.

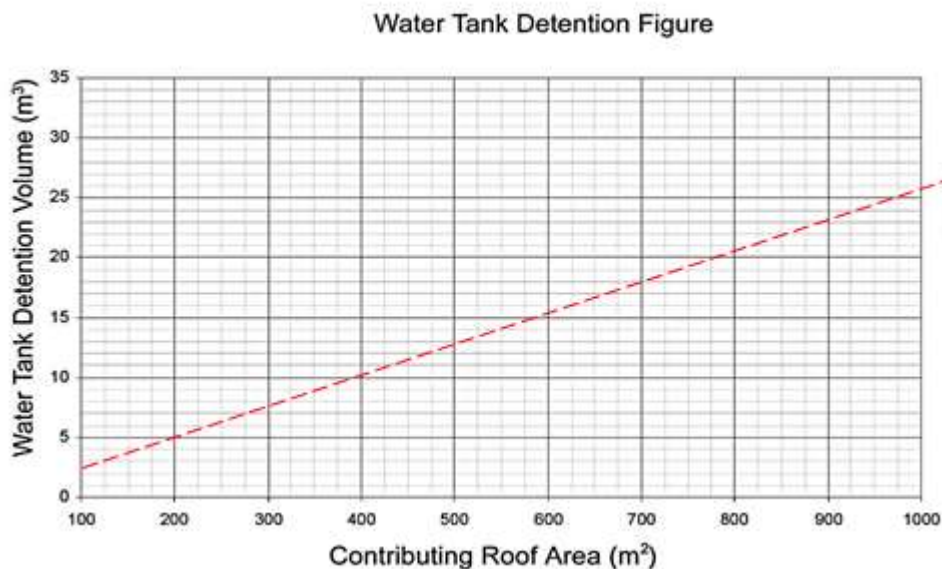

Figure 8-38: Water tank detention storage volumes

The required orifice size is a function of the storage volume and the depth of water above the orifice. This depends on the tank size selected to accommodate the water use and attenuation volume. The tank diameter, in conjunction with the attenuation volume to be stored will provide the depth of water number. This number will then be used with an orifice equation ($Q = 0.62A(2gh)^{0.5}$). Take the total detention volume and convert it to m³/s to determine the discharge from the tank and that discharge should discharge over a 24-hour period. Where the

¹⁴⁰ Auckland Regional Council, 2003

calculation shows an extended detention orifice as being less than 10 mm, use 10 mm as the orifice size.

The design approach is to determine the Q_{10} for the predevelopment condition and design the orifice size based on the depth of attenuation storage in the tank and the limitation on peak discharge.

Commercial and industrial sites will have more concern over the percentage of rainfall that becomes runoff than residential development. The percentage of time that rainfall becomes runoff needs to be calculated using daily water use, roof area and tank size. Roof areas above 500 m² need to be considered individually and a water budget established.

In those situations, attenuation of runoff may be required due to a possible larger expanse of roof area in conjunction with smaller water use.

As detailed in Figure 8-37, the water tank has three outlets:

- Water supply outlet for site water use,
- An outlet for the attenuation storage, and
- An overflow pipe for those flows that exceed the tank storage.

The water supply outlet is a standard hose connection to a pump or outlet depending on gravity feed to the water use. The outlet from the attenuation storage provides a controlled release for larger storms to reduce downstream stormwater flow increases and the overflow pipe is for all storms to flow when the tank is full of water.

Determining detention volumes and sizing outlets

The volume of storage needed for detention purposes can be addressed with one storage volume (the water quality volume). The tank elevations can be calculated once the attenuation storage and orifice size have been determined per the following.

1. Select a tank size based on site water needs and needed attenuation storage.
2. Set the water supply outlet at least 200 mm above the tank bottom to allow for debris settlement.
3. Total volumes needed for attenuation and site use are added together. These volumes then must be added to the minimum storage level (volume of tank/height of tank x 200 mm) to ensure that the tank is large enough to accommodate the three storages.
4. Determine the elevations of the various storages. Minimum storage level = 200 mm. Site water use = height of tank/volume of tank x site water use volume = height of water use elevation. This must be added to 200 mm to get elevation in tank of attenuation orifice invert.
5. Calculate invert height of overflow pipe. Overflow invert height = height of tank/volume of tank x attenuation storage volume = height of overflow pipe invert elevation. This must be added to the site water use orifice invert elevation to get the correct overflow elevation.

Water tanks in a residential neighbourhood



8.5.10.6 Case study – Rain tank

A water tank is proposed for a home in Te Aroha. The architects design plans show that the home has a roof area of 250 m² and it is being designed for a daily water use of 500 litres/day as the tank is the sole supply for domestic water.

Design steps

1. With the roof area being 250 m² and a water use of 500 l/d, calculate the amount of water that can be used where the annual rainfall is 1,250mm. With one m² of roof area providing one litre of water, the total amount of water available is 312,500 litres minus a 15% wastage factor. So annual amount of rainfall that can be used for water supply is 265,625 litres.
2. Daily water consumption is 500 litres/day or 182,500 litres per annum. This indicates that the non-potable usage can be supplied by the water tank with no need for periodic top ups.
3. At a usage rate of 500 litres/day, the minimum tank size has to accommodate at least 5,000 litres for dry periods (500 l x 10 days). As the water tank is used as the sole supply of domestic water the minimum tank size is 25,000 l. It is recommended that the water tank be sized to hold at least 5,000 litres for domestic storage to account for times where large storm capture can augment supply.
4. Regarding detention, Figure 8-38 provides detention storage requirements for various roof areas. In terms of extended detention storage, the tank needs to have 6.0 m³ of storage for detention purposes.
5. Adding the two volumes together gives a total tank volume of 11.0 m³. In addition there needs to be 200 mm of water at the bottom of the tank to accumulate organic matter that enters the tank. The height can convert to volume once a tank is selected.
6. For this case study, a 25,000 l tank is selected with a diameter of 3.58 m and a height of 2.93 m.
7. Water supply level 200 mm high (mains augmentation, governed by a ballcock. Storage below minimum level = $(25,000/2,930) \times 200 = 1,706$ l
8. Total volumes needed are 5,000 l + 6,000 l + 1,706 l = 12,706 l. So the tank is large enough to hold the various volumes.
9. Height of long-term storage = $2,930/25,000 = 0.117$ mm/l
10. Depth of domestic use storage = $5,000 \times 0.117 = 585$ mm + 200mm of dead storage = 785 mm from bottom of tank.
11. Depth of detention storage = $6,000 \times 0.117 = 702$ mm = $702 + 785 = 1,487$ mm from tank bottom.
12. Extended detention orifice sizing – Using orifice equation with a release rate of 0.07 l/s (6000 l/86,400 sec.), the orifice size is 6.2 mm, so use a minimum orifice size of 10 mm.

A schematic of the water tank with elevations and storage volumes is shown in Figure 8-39 and Figure 8-40 below.

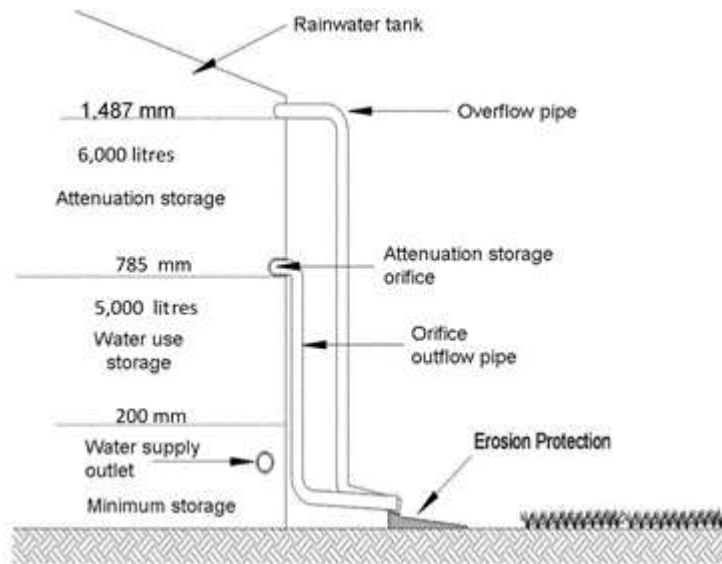
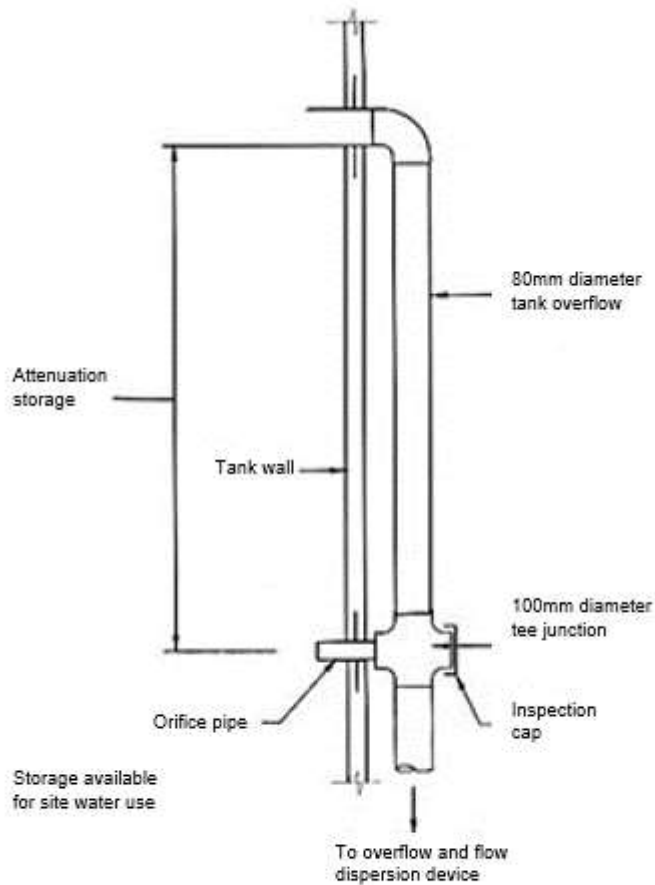

Figure 8-39: Water tank schematic showing case study elevations and volumes



Notes:

1. Maximum orifice pipe length is 150mm. Allow 75mm clearance from end of pipe to outside of tank wall.
2. Fix orifice pipe to 100mm diameter tee junction using reducer fittings.

Figure 8-40: Orifice and exterior pipe details¹⁴¹

¹⁴¹ Hawke's Bay Regional Council, 2009

8.5.11 Compacted soil remediation



Description: Soil remediation reduces compaction that is often a by-product of site construction activities. Compaction occurs as construction equipment repeatedly travels across a site or when fill material, needing a defined compaction, reduces soil permeability rates.

8.5.11.1 Background

Soil disturbance/compaction in urban areas occurs during construction cutting and filling operations, general grading operations, and other processes of running heavy equipment over the soil. After construction, continued compaction can occur with site activities such as walking, sports, and even parking heavy vehicles on grassed areas. Slow improvements in soil compaction may occur with time in relatively undisturbed areas by deep rooted plants or by soil insects or other boring animals. Basically, soil infiltration to ground is usually significantly degraded compared to natural soil conditions and is commonly overlooked during hydrologic analyses and design. Knowing the likely effects of this soil compaction on urban hydrological conditions is critical for designing safe drainage systems. Restoring the infiltration capacity of a soil is also possible and can provide significant benefits in stormwater management.

There are many different types of soils with different abilities to cope with construction pressures and to recover afterwards. Management during earthwork stages and subsequent restoration needs to be appropriate to the type of soil. Clays are particularly at risk of compaction. Pumice soils from the Central Volcanic Region are resilient to a point but surface crusting can occur if the pumice particles are crushed. Soils with a high water table are also vulnerable to surface crusting and deeper compaction. Organic soils (peats) are vulnerable to oxidation and consolidation, i.e. they 'shrink' due to conversion to CO₂ gas and collapse in on themselves.

In many cases, disturbed urban soils have dramatically reduced infiltration rates, usually associated with compaction of the surface soils. The saturated infiltration rates can be one to two orders of magnitude less than assumed, based on undisturbed/uncompacted conditions.

Figure 8-41 and Figure 8-42 show 3D plots of field infiltration data, illustrating water content and compaction, for both sands and clays. Four general conditions were observed to be statistically unique. Compaction has the greatest effect on infiltration rates in sandy soils, with little detrimental effects associated with higher soil-water content conditions (the factor usually considered by most rainfall-runoff models). Clay soils, however, are affected by both compaction and soil-water content. Compaction was seen to have about the same effect as saturation on clayey soils, with saturated and compacted clayey soils having very little effective infiltration.

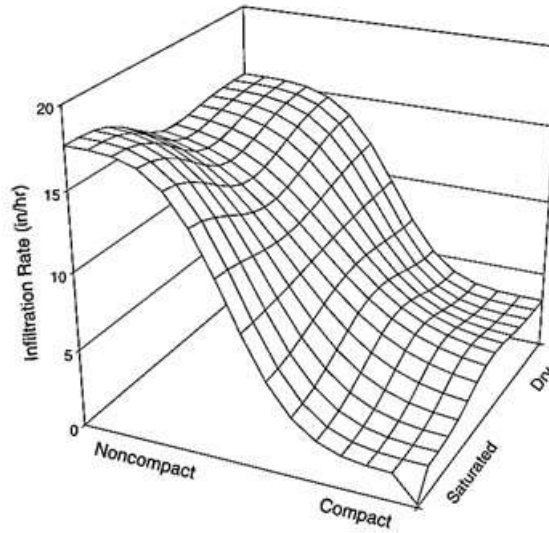

Figure 8-41: Infiltration rates for sandy soil conditions¹⁴²

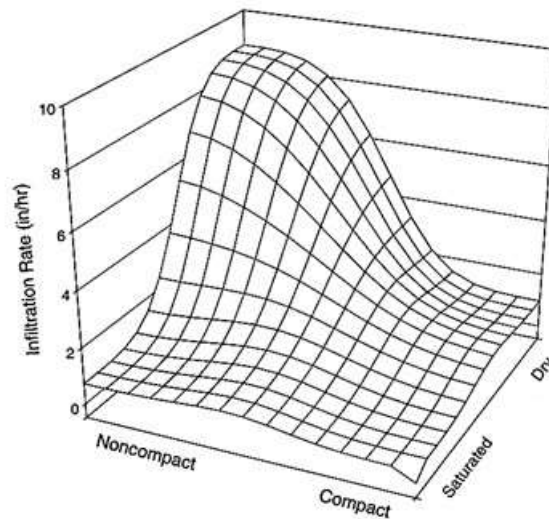

Figure 8-42: Infiltration rates for clayey soil conditions¹⁴²

Protecting the biological integrity of the soil goes a long way to restoration for all soil types.

8.5.11.2 Description

When considering remediation, it is important to understand what topsoil is and how it relates to subsoils.

Top soil refers to the top layer of soil that has a mix of vegetative matter and soil in it. Topsoil provides the richest amount of organic matter for germinating seeds and this organic matter colours the soil dark brown. Organic matter helps soil structure, holds water and nutrients. Microorganisms, from bacteria to fungi, populate the soil keep the cycling of organic matter active.

Topsoil is the best substrate for plant growth with its rich nutrients and protected moisture trapped in small, open underground pockets. Good soil is about 50% air space. The air space allows nutrients and water to circulate as well as roots to grow. When soil particles are too close together, compaction occurs.

Subsoil is beneath topsoil and does not have high organic matter concentrations so has lighter and varying colours, such as red or yellow.

¹⁴² Pitt, 2002

8.5.11.3 Construction approach to soil conditioning

Similar to other approaches for stormwater management, the first step is to minimise compaction. Avoid compaction in the first place by limiting areas where construction or worker equipment travels. Mark undisturbed areas to limit entry.

The type of soil remediation varies depending on existing soil type, topography and nature of the earthworks (cut or fill). Earthworks must be designed to maximise the opportunities for remediating surface soil. Where soil remediation is not possible for geotechnical reasons, proposals should specify what will be achieved to provide topsoils in geotechnically critical areas, including vegetative proposals.

Compaction problems are most evident where clay soils exist on site. Thus, remediation of clay soils requires more steps to maintain permeability than do other soils.

A major consideration of soils remediation relates to drainage. Compaction can lead to drainage of water onto neighbouring properties and increased risk of localised flooding. There also has to be attention given to the potential for land slips, especially in some types of clay soils.

8.5.11.4 Method of conditioning¹⁴³

Reinstating surface soil (topsoil and conditioned parent clays) requires careful planning and coordination through the earthworks stages of subdivision development. It is essential to work with caution as compaction can lead to drainage of water onto neighbouring properties and increased risk of localised flooding. Infiltration into some types of clay can lead to land slips.

During the initial stripping stages, it is recommended that two types of stripped material be stockpiled. The topsoil should be stripped and stockpiled separately from the underlying 200 mm (approximately) subsoil. Only after stockpiling these surface soils should the underlying materials be used for the bulk earthworking of cut and fill areas. On completing bulk earthworks, the surface soil can be rehabilitated by scarifying and/or subsoiling the finished fill surface, and placing stockpiled subsoil and topsoil in layers similar to their pre-earthwork condition.

Topsoil in this guideline is defined as the generally dark coloured mineral soil immediately underlying vegetation and any dense root mat. It contains roots and humus, has a generally friable structure and is typically about 100 mm thick, although this depth can be highly variable. The underlying subsoil is 200 mm – 300 mm thick and is indicative of local geology. It can be distinguished from the parent material by its rootlets, lower water content and better structure.

After stripping and bulk earthworks are completed, the parent soils should be conditioned using the following methods:

1. Subsoiling – ripping depths, spacing and directions and timing will be site specific depending on soil type, topography and drainage paths.
2. Scarifying and adding gypsum (if the soils are clay based) – gypsum should be added to the surface at concentrations as per the manufacturer's recommendation and then scarified and mixed into the top 100 mm of parent materials.

After remediating the parent materials, the stockpiled subsoil and topsoil layers are placed and only lightly compacted. Seeding of the topsoil should be undertaken according to normal seeding specifications.

Another way to restore compacted urban soils is through the use of an agricultural spader tillage implement that has been used successfully to restore compacted soils in disturbed areas. This is not a typical rotary tiller that can form a hardpan, but uses a shovelling action to lift up the soil, which does the least soil structure damage. The Tortella Spader from Italy is a preferred spader implement. Dramatic restorations in soil structure are possible with the spader, while deep chisel plowing has also been used, but less successfully¹⁴⁴.

¹⁴³ North Shore City Council, 2006

¹⁴⁴ Pitt, 2012



La Spader Italian Farm Implement¹⁴⁵

Building activities on individual lots will have further detrimental effects on the surface soil, even after the remediation of soil undertaken for subdivision construction. Following any excavation and/or regrading required developing individual lots, the affected surface soil, outside of the building and pavement footprint, must be remediated. Material from excavations will need to be hauled off site or, if the soils are suitable, reworked back into the subsoil and topsoil layers.

8.5.11.5 Remediation of other soils

The main concern with pumice and soils having a high water table is crusting of the surface. In those areas, it is important to scarify the surface of the worked soil using a spader type tillage implement and then providing grass seed. Scarifying to improve permeability works best in low clay content soils

Peat soils are unique and the main concern with them is shrinkage where the soil can collapse in on themselves. In those situations, it is important to maintain site hydrology to limit collapse.

8.5.11.6 Managing compaction

Once remediation has been accomplished, there are a number of steps that should be taken to limit further creep in compacted areas.

Reroute traffic. Shift machinery, vehicle, and foot traffic away from the compacted area. Provide alternative routes and block off the area with barriers such as signs and fences. Do this long enough to give the area a rest and consider protecting the area permanently by keeping paths and roads to restrict traffic to one area.

Try to designate already degraded soil for paths and household construction to limit the spread of compaction.

Put in a cover crop. The roots break up the soil, and then turn it in the soil with a tiller to increase organic matter in the soil and increase aeration.

Work in organic material. While you aerate the soil, add compost or mulch.

¹⁴⁵ <http://www.bdimachinery.net/29.html>

8.5.12 Oil/water separators



<p>Description: Oil and Water Separators are designed and constructed to capture and treat stormwater runoff through:</p> <ul style="list-style-type: none"> • Specific gravity separation • Surface area increases • Sedimentation (limited) 	Stormwater Management Function	
	<input checked="" type="checkbox"/>	<p>Water quality</p> <p><u> x </u> Metals</p> <p><u> x </u> Sediment</p> <p><u> ✓ </u> TPH</p>
	<input type="checkbox"/>	Flood protection
	<input type="checkbox"/>	Stream channel erosion protection

Oil/water separator devices are applicable for treating stormwater runoff from areas where hydrocarbon products are handled or where hydrocarbon loads can be very high. They should be located as close to the source of the hydrocarbons as possible to retain the oil in a floatable, non-emulsified form.

Oil/water separators are not usually applicable for general urban stormwater runoff treatment as the oil is often emulsified or has coated sediments and is too difficult to separate. For stormwater runoff, oil/water separators would primarily be applicable in areas where there is a very high hydrocarbon load and the oil/water separator would be used in conjunction with another device to function as part of a treatment train.

Emulsification occurs when two liquids that normally do not mix do so either through a turbulent environment or through the use of an emulsifying agent. In the case of oil/water separators, the turbulence of stormwater flows can cause the mixing of oil and water. It is important that catchment areas draining to oil/water separators be as small as possible to reduce the potential for emulsification to occur. If that happens the effectiveness of oil/water separators will reduce significantly.

In areas where there is significant potential for accidental spills, oil/water separators may be applicable if the material having spill potential has a specific gravity less than water. From a sedimentation standpoint, oil/water separators will capture sand or grit particles but smaller sediments will either pass directly through the system or may be resuspended in subsequent storms.

There are a number of different products that are available for use as oil/water separators. These available products should be considered carefully and designed according to their manufacturers recommendations. Most of these products can achieve a maximum concentration of 5 mg/l. One product that can be used as a last resort is an American Petroleum

Interceptor (API) that normally can achieve 15 mg/l concentration, which is less desirable than other products due to the greater concentration of oil in the discharge from the device. If an API oil/water separator is used, it shall be designed in accordance with Ministry for the Environment guidelines¹⁴⁶.

It is not the intention here to provide a list of suitable devices. When an oil/water separator is proposed for a given site, documentation from the manufacturer should be submitted to verify the performance in terms of discharge concentration

¹⁴⁶ Ministry for the Environment, 1998

9 Outlet design

9.1 Introduction

Discharges from pipes, culverts and channels frequently cause erosion problems if proper mitigation is not applied. Mitigation for this erosion requires dissipation of discharge energy prior to release into an unprotected receiving environment. Many design methodologies are available for designing inlet and outlet erosion or scour protection. Most are empirically derived and therefore do not necessarily apply to all conditions. For this reason, it is critical that the Design Engineer selects a design methodology that is appropriate for the receiving environment conditions that the outfall will be discharging to.

The only safe procedure is to design the inflows and outfalls on the basis that erosion is to be expected and therefore mitigated. Once constructed it is important to inspect the inflows and outlets after major storms to determine if the protection must be increased or extended.

Two types of erosion result from stormwater discharges:

- Local scour in the vicinity of pipe or channel outfall
- General channel degradation further downstream

Local scour is the result of high velocity flow or even channelised flow at inlets or outlets. It tends to have an effect for a limited distance downstream. Natural channel velocities are almost universally less than pipe outlet velocities, because the channel cross section, including the floodplain, is generally larger than the pipe flow area while the frictional resistance of a natural channel is greater than the frictional resistance of a concrete pipe. Thus, flow eventually adjusts to a pattern controlled by the channel characteristics.

Channel degradation represents a long term lowering of the stream channel, which may proceed in a fairly uniform manner over a long length or may be evident in one or more abrupt drops. A number of stream channels in the region are degrading as a result of increased stormwater runoff volumes from changed land use, initially from forest to rural use and further from rural to urban use. Waterway instability issues are an essential element of overall stormwater management design.

Inlet protection is essential to limit the amount of work that a stormwater management device needs to do to reduce discharge of contaminants. Scour or high velocities at device inlets and cause sediment scour or resuspension of contaminants deposited during previous events.

Outlet protection for culverts, stormwater outfalls or ditches is essential to prevent erosion from damaging downstream channels and receiving environments. Outlet protection can be a channel lining, structure or flow barrier designed to lower excessive flow velocities from pipes and culverts, prevent scour, and dissipate energy. Good outlet protection will significantly reduce erosion and sedimentation by reducing flow velocities.

The purpose of this section is to present information that facilitates design for inlets and outlets that dissipate energy to minimise inlet and outlet velocities and subsequent scour. This will facilitate water quality function and reduce subsequent maintenance issues.

Example of erosion at a pipe outfall



9.2 Design references

The following references, provided in no order of priority, provide a range of design methodologies that can be applied:

- Hydraulic Energy Management: Inlet and Outlet Design for Treatment Devices, Technical Report 2013/018. Auckland Council.
- HEC 14: Hydraulic Design of Energy Dissipators for Culverts and Channels, US Dept. of Transportation.
- HY-8 Culvert Hydraulic Analysis Program, Version 7.60 (USDOT, 2019). – Culvert design program with an on-board scour or erosion protection tool.
- HEC 15: Design of Roadside Channels with Flexible Linings (Metric) (USDOT, 1988).
- HEC 11Si, Design of Riprap Revetment, Metric Version (Archived on-line document, USDOT, 1989). In the process of being superseded by the following reference, but still useful.
- NCHRP Report 568, Riprap Design Criteria, Recommended Specifications and Quality Control (Transportation Research Board, 2006).

9.3 Design approach

Key design elements include:

- Pipe or channel grade
- Inlet and outlet velocity
- Riprap aprons
- Engineered energy dissipaters
- Flow alignment and outfall setback in freshwater receiving environments
- Erosion control in coastal environments

These are summarised below.

9.3.1 Pipe or channel grade

To minimise the complexity of analysis and design of inlet or outlet protection structures, the first step is to look for ways to reduce the magnitude of pipe or channel outlet protection by having an invert grade as low a grade as possible, for example by using a drop structure in a pipe a short distance above the outfall.

A key element to consider is whether the overall system operates under inlet or outlet control, which relates to the hydraulic grade of the system.

Inlet control occurs on steeper grades when the inlet configuration controls the hydraulic capacity of the pipe and the outlet is free-flowing. Under inlet control, the outlet is not submerged and the differences between the upstream and downstream head is large. Key factors relate to headwater depth and entrance conditions.

Outlet control occurs when hydraulic capacity is governed by friction through the hydraulic element and tailwater depth. Hydraulic performance is defined by the difference between headwater and tailwater depth, inlet condition and pipe slope, roughness and length.

9.3.2 Inlet and outlet velocities

The design and analysis of riprap protection, stilling basins, and other types of structures can be a complex task to accomplish. The first step is to look for ways to reduce the need for inlet or outlet protection by having grades no steeper than possible (possibly using a drop structure in

pipe). When considering inlet and outfall velocities, there is value in considering what velocities natural channels can tolerate prior to eroding, Table 9-1 below provides guidance on this topic.

The primary consideration in selecting the type of inlet or outlet protection is the velocity for pipes or channels, which is dependent on the flow profile associated with the design storm.

Mechanisms for reduction of inlet scour or resuspension of previous deposited contaminants can include¹⁴⁷:

- Dispersion of low velocity flow across a landscaped area or filter strip.
- Dispersed flow through kerb cuts.
- Dispersed flow from paved areas through distributed inlets.
- Flow through level spreaders or swales.

Pipe flow may be controlled by:

- The type of inlet
- The throat section
- The pipe capacity or
- The type of outlet.

The type of control may change from outlet control to inlet control depending on the flow value.

For inlet control, the outlet velocity is assumed to be normal depth as calculated by Manning's equation.

For outlet control, the outlet velocity is found by calculating the channel flow from Manning's equation with the calculated tail-water depth or the critical flow depth of pipe, whichever is greater.

Table 9-1: Maximum permissible velocities for unlined channels¹⁴⁸

Material	Mean velocity (m/s)
Fine sand, colloidal	0.4
Sandy loam, non-colloidal	0.5
Silt loam, non-colloidal	0.6
Alluvial silts, non-colloidal	0.6
Ordinary firm loam	0.8
Volcanic ash	0.8
Stiff clay, very colloidal	1.1
Alluvial silts, colloidal	1.1
Shales and hardpans	1.8
Fine gravel	0.8
Graded loam to cobbles, non-colloidal	1.1
Graded silts to cobbles, colloidal	1.2
Coarse gravel, non-colloidal	1.2
Cobbles and shingles	1.5

9.3.3 Riprap aprons

Protection at inlets and outlets can take the form of riprap placement with the stone sizing being assessed as part of the storm drainage design and using these guidelines. Riprap protection is

¹⁴⁷ Buchanan et al, 2013

¹⁴⁸ Fortier et al, 1926

usually less expensive and easier to install than concrete aprons or energy dissipaters. A riprap channel lining is flexible and adjusts to settlement; it also serves to trap sediment and reduce flow velocities.

Riprap aprons should not be used to change the direction of inlet or outlet flow: an impact energy dissipater is more appropriate for this. Riprap aprons aim to manage the transition of piped stormwater into a stream channel primarily by their higher Manning's roughness coefficient, which slows the water velocity.

Riprap aprons should be constructed, where possible, at zero percent grades for the specified length.

Grouted riprap may be subject to upheaval from periodic saturation of clay subgrades and is therefore not generally recommended for velocity protection. Upheaval can crack the grout resulting in undersized riprap size for the velocities of flow. In general, un-grouted properly sized riprap provides better assurance of long-term performance.

Laying riprap directly on soils can allow the water to hit soil particles, dislodging them and causing erosion. Filter cloth laid between the soil and riprap will reduce this concern. Filter cloth is graded on the thickness and permeability characteristics. A qualitative judgement is usually made on the appropriate grade to prevent erosion and prevent puncture by riprap.

9.3.4 Engineered energy dissipators

There are many types of energy dissipators. Commonly used varieties include stilling basins, baffle blocks within a headwall and impact energy dissipaters. The figure below demonstrates an engineered stilling basin designed to trigger a hydraulic jump in combination with a tail-water condition.

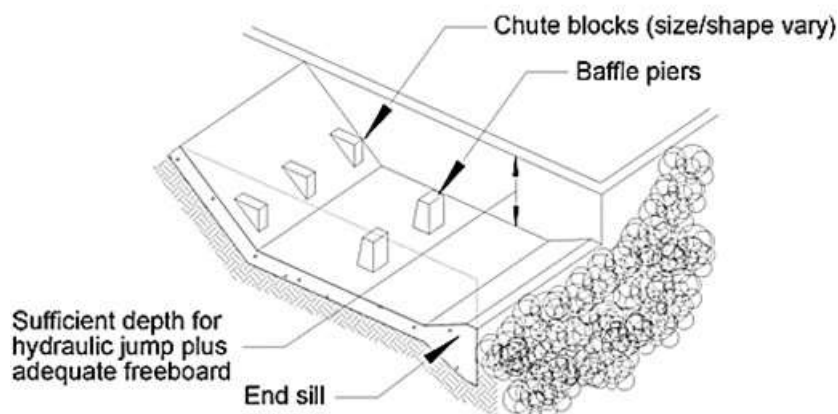

Figure 9-1: Engineered stilling basin¹⁴⁹

Engineered energy dissipators including stilling basins, drop pools, hydraulic jump basins or baffled aprons are required for inlets and outfalls with design velocities more than 6 metres per second.

Energy dissipators should be designed using published or commonly known techniques found in references including:

- Hydraulic Energy Management: Inlet and Outlet Design for Treatment Devices, Technical Report 2013/018. Auckland Council, and
- Hydraulic Design of Energy Dissipators for Culverts and Channels, HEC 14, July 2006, Metric Version. U.S. Department of Transportation, United States.¹⁵⁰

¹⁴⁹ Auckland Regional Council, 2003

¹⁵⁰ <https://www.fhwa.dot.gov/engineering/hydraulics/pubs/06086/hec14.pdf>

Energy can also be dissipated using drop structures within a channel that can be specifically designed to be robust, visually appealing and to enhance ecological values with riparian planting and creating a diverse flow regime with pools and riffles.

The following photos illustrate a single-step drop structure and a multi-step drop structure in a perennial stream in Hamilton¹⁵¹.



9.3.5 Outfalls to channels

Depending on the location and alignment of a proposed new pipe outfall or outlet channel and the receiving stream, outfall structures can have a significant effect on receiving channels. If the alignment of the proposed new outfall is at too greater angle to the existing channel flow, erosion effects will result. Alignment at a right angle to a stream for example will force the flow to make a 90° angle to the direction of flow. This can cause scour of the opposite stream bank as well as causing significant turbulence at the point of entry.

The following provides some design criteria that can be adopted for the design of confluence junctions¹⁵²:

- The design water surface elevations in the two joining channels should be approximately equal at the upstream end of the confluence.
- The angle of junction intersection should be preferably zero but not greater than 12 degrees.
- Favourable flow conditions can be achieved with proper expansion in width of the main channel below the junction.

¹⁵¹ Photos sourced from Eugene Vodjansky, Bloxham Burnett and Olliver

¹⁵² US Army Corps of Engineers, 1991

- Rapid flow depths should not exceed 90% of the critical depth (Froude number should be greater than 1.13) to maintain stable rapid flow through the junction.

Model tests of many confluence structures indicate very little cross wave formation and turbulence at the junction if these criteria are followed.

If the junction angle cannot be less than 12 degrees then erosion protection will be required on the opposite bank of the main channel to deflect flows.

The impact of new pipe outfalls can be significantly reduced on receiving streams by locating them further back from the stream edge and digging a channel from the outfall to the stream, as shown in Figure 9-2 below. This would allow for energy dissipation before flows enter the stream. Note the channel would need to be designed in accordance with the above criteria.

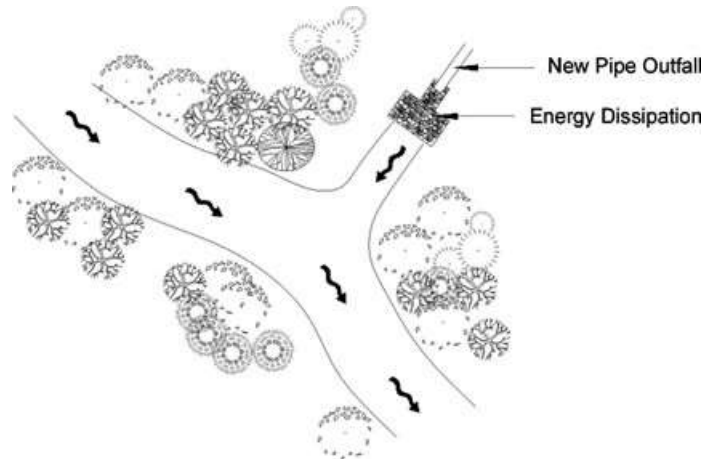

Figure 9-2: Set back outfall into a stream¹⁴⁹

As a minimum, the pipe outfall should be located far enough back from the stream edge to prevent the energy dissipater intruding on the channel.

9.3.6 Outfalls in coastal areas

Discharges and outlet structures may give rise to a number of adverse effects on the coastal environment if they are constructed of inappropriate materials and/or are poorly sited. For example, a discharge may cause or exacerbate erosion of a beach or an outlet may detract from the natural character or amenity value of the coastal environment or impede public access to, from and along the coast.

If an outfall to a coastal receiving environment is proposed, specific design advice shall be sought from an appropriately qualified and experienced coastal scientist or engineer.

A number of items are listed below for consideration to avoid/minimise adverse effects on the natural character, amenity or public access values of the coastal environment, however these don't replace specialist advice discussed above:

1. An understanding of local coastal processes in the area is required to inform the design of any proposed outfalls in the coastal environment, i.e. tides, currents along the shore, sand or sediment migration, wave erosion, etc.
2. Discharging in such a location that will not unnecessarily cause or exacerbate erosion, particularly of beach materials. For a discharge to a beach, this may involve locating the point of discharge away from the active beach system, e.g. at or near an adjacent headland.
3. Where there are multiple points of discharge to a beach system, consideration should be given to combining discharges to a common point of discharge, including via a common structure.
4. Ensuring the visual form and appearance of the outlet does not detract from its immediate surrounds and the natural character of the coastal environment, e.g.

ensuring the structure is complementary to its locality rather than contrasts with that environment. The use of locally sourced rock and/or coloured and sculpted concrete forms may be appropriate.

5. Keeping the “footprint” of the structure to a minimum.
6. Incorporating the discharge pipe into another structure, e.g. a boat ramp, to minimise the number of structures in the coastal environment.
7. Locating the outlet and discharge in such a position as to not create an obstacle to public access to, from or along the coastal marine area.

Natural looking coastal outfall



9.4 Detailed design

The design of outlet protection can be undertaken following the approach outlined in *Hydraulic Design of Energy Dissipators for Culverts and Channels*¹⁵³ mentioned in Section 15.3.4. This is widely used by design professionals and is recommended by Waikato Regional Council.

An alternative option is a simplified approach, which is conservative in order to ensure that adequate channel protection is provided. This approach requires that velocities for the design discharge be calculated and input into equations outlined below. The figure below illustrates the key design parameters to use when using this method.

¹⁵³ Kiilgore et al, July 2006

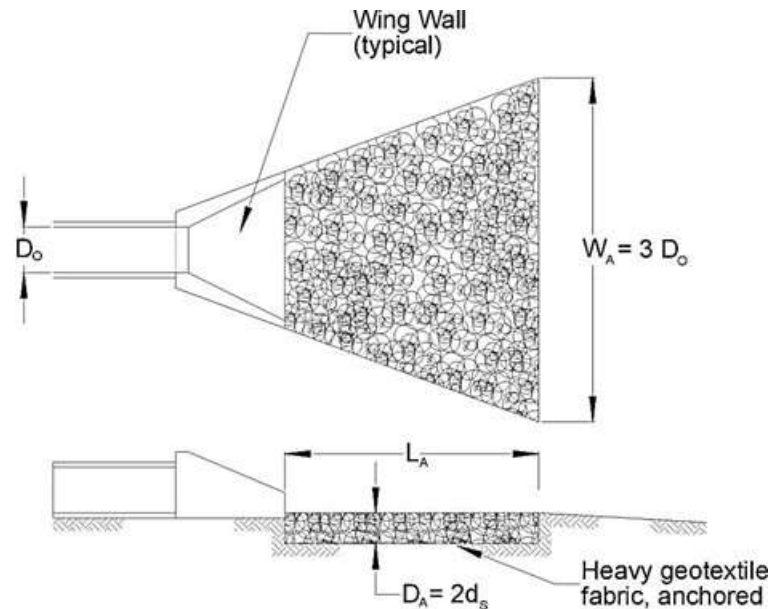

Figure 9-3: Schematic of riprap outfall protection¹⁴⁹

1. Determine the discharge velocity for the design storm. For stormwater management structures the design storm is the maximum flow that can be carried by the pipe. This will normally be the 10-year ARI design flow.
2. Enter that value into the following equation to determine the equivalent diameter of the stone.

$$d_s = 0.25 \times D_o \times F_o$$

Where:

d_s = Riprap diameter (m)

D_o = Pipe diameter (m)

F_o = Froude number = $V/(g \times d_p)^{0.5}$

(Froude number expresses the flow state: 1 = critical flow, <1 = sub-critical, > 1 = super-critical flow. No design should allow a Froude number between 0.8 - 1.2 to avoid unstable flow)

d_p = Depth of flow in pipe (m)

V = Velocity of flow in pipe (m/s)

3. The thickness of the stone layer is 2 times the stone dimension. $D_A = 2d_s$
4. The width of the area protected is 3 times the diameter of the pipe. $W_A = 3D_o$
5. The height of the stone is the crown of the pipe + 300 mm.
6. The length of the outfall protection is determined by the following formula.

$$L_a = D_o(8 + 17 \times \log F_o)$$

Where:

L_a = Apron length (m)

g = 9.8 m/s²

As can be seen from the equations, any reduction in the discharge velocity will reduce the stone size and apron length.

Mechanisms to reduce velocity prior to discharge from the outfall are encouraged, such as drop manholes, rapid expansion into pipes of much larger size, or well up discharge designs.

9.5 Construction

Construction of the inlet or outfall protection must be undertaken at the same time as construction of the pipe outfall itself.

It is best to construct the inlet or outfall unit from the bottom up, to prevent concentrated flows (if there is potential for flows to discharge into the device during construction) from being discharged into an un-stabilised location.

If construction of the system commences at the top of the structure, the entrance to the system should be blocked off to prevent flow from travelling through the pipe until the outlet protection is completed.

Riprap velocity dissipation at pipe outfall



Inlet and outfall structures associated with stormwater management ponds should be constructed in a similar fashion. Once the embankment has been completed and the pipe structures installed, the erosion protection must be constructed.

It is important that a sequence of construction be established and followed, such as the following for example:

1. Clear the foundation area of trees, stumps, roots, grass, loose rock, or other unsuitable material.
2. Excavate the cross-section to the lines and grades as shown on the design plans. Backfill over-excavated areas with moist soil compacted to the density of the surrounding material.
3. Ensure there are no abrupt deviations from the design grade or horizontal alignment.
4. Place filter cloth and riprap to line and grade and in the manner specified. Sections of fabric should overlap at least 300 mm and extend 300 mm beyond the rock. Secure the filter cloth at the edges via secure pins or a key trench.
5. Ensure the construction operations are undertaken so as to minimise erosion or water contamination, with all disturbed areas vegetated or otherwise protected against soil erosion.
6. For coastal sites, undertake construction at periods of low tide.

9.6 Operation and maintenance

Key operation and maintenance tasks include the following:

- Inspect inlet and outlet protection on a regular basis for erosion, sedimentation, scour or undercutting

- Repair or replace riprap, geotextile or concrete structures as necessary to handle design flows
- Remove trash, debris, grass, or sediment

Maintenance may be more extensive as smaller rock riprap sizes are used, as people may be tempted to throw or otherwise displace stones or rocks.

10 Landscaping

10.1 Introduction

Landscaping is critical to improving both the function and appearance of stormwater management devices. It has aesthetic, ecological and economic value that is often not recognised during site design and construction. In almost all cases, compliance with regulatory requirements is the key driver and the issue of how a stormwater device fits into the local landscape can often be overlooked.

Moreover, where the initial developer is not the eventual property owner, there may not be a long-term interest in landscaping.

Where the local council assumes the maintenance responsibility for the device and/or becomes the owner of the device, landscaping issues must become a standard asset management cost in the council's financial plans.

If the device is considered an eyesore, property values will go down and the general public response to stormwater management will be negative. The stormwater device must be an integral part of the development and given the same landscape attention as other parts of the site.

Example of a stormwater pond that has little aesthetic value



10.2 Objective

The objectives of landscaping stormwater management devices are to:

- Improve their aesthetics
- Improve their water quality and ecological function, and
- Increase the economic value of the site.

A good landscape plan will consider all three objectives. This means involving a professional landscape architect with experience in natural system design.

Considerations include:

- Site soils
- Slopes
- Hydrologic conditions, and
- Water quality/ecological benefits.

The following discussion expands on the three objectives.

10.2.1 Aesthetic appeal of stormwater devices

Aesthetics is a subjective yet very important aspect of everyday life. It is a concept that is difficult to define quantitatively. Something that is good aesthetically tends to be considered tasteful, pleasing, appropriate and fitting for its location. Tastes differ, and disagreement about what is an aesthetic amenity is common. The goal of this section is to provide guidance on how

Green wall on a building in Paris



to ensure that stormwater devices are designed as an asset to the property owner and to the overall community.

10.2.2 Water quality and ecological function

Attention to landscaping as a component of stormwater management devices can have a significant positive effect on water quality and ecological function. Shading of devices can reduce thermal impacts on receiving systems. Vegetated buffer zones (woody or grassed) can reduce sediment entry, and natural vegetation promotes local ecological diversity.

Landscaping plans should consider:

- Chemical use reduction
- Contaminant source reduction, and
- Impervious surface mitigation.

Projects should be designed to minimise the need for toxic or potentially contaminating materials such as herbicides, pesticides, and fertilisers within the stormwater management device area.

Materials that could leach contaminants or pose a hazard to people or wildlife should not be used as components of a stormwater device (examples can include chemically treated wood or galvanised metals).

Good landscaping can also reduce impacts of impervious surfaces by incorporating swales adjacent to paths and access ways.

10.2.3 Economic value of the site

A number of studies demonstrate the economic benefits of properly landscaped stormwater systems on the overall property values in the vicinity of the devices. These are summarised as follows:

- A study in Maryland in the U.S. found that properly designed stormwater management ponds increased adjacent property values by 10 - 15 %
- The U.S. EPA's literature review of the impacts of urban stormwater ponds on property values is available on EPA's website at www.epa.gov/OWOW/NPS/runoff.html, and
- The City of Christchurch has been engaged in natural stream restoration and has identified significant monetary benefit to property values for properties abutting the restored stream channels.

10.3 Native vegetation

This guideline encourages the use of native vegetation in stormwater management devices where they are appropriate. Native plants are defined as those species found in the Waikato Region before European migration.

Native species have distinct genetic advantages over non-native species for planting. As they have evolved here naturally, indigenous plants are best suited for our local climate. This translates into greater survivorship when planted and less replacement and maintenance during the life of a stormwater management device. Both of these attributes provide cost savings for the device owner.

People often plant exotic species for their ornamental value. While it is important to have aesthetic stormwater management devices for public acceptance and the maintenance of property value, it is not necessary to introduce foreign species for this purpose. There are a number of native species that are aesthetically pleasing and can be used as ornaments.

10.4 General landscape guidance

There are several components of a landscape plan. They should be considered individually and together to ensure implementation of a successful landscape plan. The components include the following:

- Stormwater device area
- Landscape screening
- Soils
- Site preparation
- Planting, and
- General guidance.

10.4.1 Stormwater device area

The device area includes the stormwater management device itself, maintenance access ways, fencing and a minimum buffer around these elements. The buffer ensures that adequate space is available for landscaping. Other site elements can be located within the buffer if the need arises. The landscape plan should designate the device and buffer area.

Bioretention adjacent to a road can be an attractive amenity to the overall site



10.4.2 Landscape screening

Device elements can include a number of components including fences, concrete headwalls, outfall pipes, riprap, gabions, steel grates, steep side slopes and manhole covers. These elements can be screened from general public view with plants. Landscape screens of shrubs and trees could have a significant beneficial effect on public perception if used effectively.

10.4.3 Soils

It is necessary to test the soil in which you are about to plant in order to determine the following:

- pH
- Major soil nutrients
- Minerals, and
- Seasonal wetness and water-retention capacity.

The soil samples should be analysed by a qualified professional who will explain the results and their implications for plant selection.

10.4.4 Site preparation

Construction areas are often compacted, so that seeds wash off the soil and roots have difficulty penetrating it. No material storage or heavy equipment should be allowed in the stormwater device or buffer area after site clearing has been completed, except to excavate and grade the stormwater management area. All construction and other debris must be removed before topsoil is placed.

For planting success, soils should be loosened to a depth of approximately 150mm. Hard clay soils will require disking to a deeper depth. The soil should be loosened regardless of the ground cover. This will improve seed contact with the soil, increase germination rates and allow the roots to penetrate the soil.

Providing good growing conditions can prevent poor vegetative cover. This saves money, as vegetation will not need to be replanted.

Native bush planting as an effective riparian ground cover



10.4.5 Planting

In selecting plants, consider their desired function in the landscape. Is the plant needed as ground cover, soil stabiliser or a source of shade? Will the plant be placed to frame a view, create a focus or provide an accent? Does the adjacent use provide conflicts or potential problems and require a barrier, screen, or buffer? Nearly every plant and plant location should be provided to serve some function in addition to any aesthetic appeal.

Certain plant characteristics are obvious but may be overlooked in the plant selection, especially:

- Size, and
- Shape.

Tree limbs, after several years, can affect power lines. A wide growing shrub may block an important line of sight to oncoming vehicular traffic. A small tree, when full grown, could block views. Consider how these characteristics can work today and in the future.

It is critical that selected plant materials are appropriate for soil, hydrological conditions and other device and site conditions. More information on adequacy of specific plant species is provided in the individual sections on each device.

10.4.6 General guidance

- Trees, shrubs and any type of woody vegetation are not allowed on a dam embankment. Root penetration of the embankment could weaken it in the future.
- Check water tolerances of existing plant materials prior to inundation of area.
- Stabilise aquatic and safety benches with emergent wetland plants and wet seed mixes.
- Do not block maintenance access to structures with trees or shrubs
- To reduce thermal warming, shade inflow and outflow channels as well as northern exposures of ponds.
- Shading of standing water reduces undesirable algae blooms
- Avoid plantings that will require routine or intensive chemical applications.
- Test the soil to determine if there is a need for amendments
- Use low maintenance ground cover to absorb stormwater runoff
- Plant stream and water buffers with trees and shrubs where possible to stabilise banks and provide shade
- Maintain and frame desirable views. Take care not to block views at road intersections or property entrances. Screen unattractive views into the site.
- Use plants to prohibit pedestrian access to ponds or steeper slopes.
- Consider the long-term vegetation management strategy of the stormwater device, keeping in mind the maintenance obligations of the eventual owners.

- Preserve existing bush areas to the extent possible.

10.5 Specific landscape provisions for individual devices

In addition to the general guidance presented above, more specific guidance is given below for individual stormwater devices (this guidance is subject to variation from site to site).

10.5.1 Ponds and wetlands

Section 9 provides design guidance for ponds and wetlands. Ponds and wetlands have several defined elements that affect landscaping, including:

- Pond shape
- Pond topography, and
- Zones of water inundation and periodic saturation.

10.5.1.1 Pond shape

Pond or wetland shape strongly influences public reaction. A rectangular pond is not seen as a 'natural' site feature and offers little in terms of amenity value. A pond with an irregular shoreline or one that apparently fits in with natural contours is more attractive.

In addition, an irregular shape has a longer edge than a rectangular pond and allows for more planting, both above and below the water line. Council recommends an irregular shoreline or one that follows existing contours. A minimum recommended buffer area around the pond is five metres above the shoreline where a reverse safety bench, as detailed in Section 9, and plantings can be established.

Ponds can be landscaped to be amenity features



10.5.1.2 Pond topography

Topography has a major effect on the range of plants that can be grown, the movement of water through the pond or wetland and public safety. Steep side slopes can be dangerous for people slipping into a pond and will affect the types of plants that can be used.

Council recommends a 300 mm deep three metre wide level bench below the normal pool level. This is recommended for safety reasons and for growth of emergent wetland plants. The plants will act to restrict public access to deeper water.

Islands, effectively placed, can also be used for multiple benefits. They can increase stormwater flow paths, provide additional landscaped areas and provide wildlife habitat. Islands also increase edge lengths and vegetated areas.

10.5.1.3 Zones of water inundation and periodic saturation

Normal pond and wetland function will result in a number of zones becoming established, each providing different landscaping opportunities.

A well vegetated wetland



Zone 1 Periodic flooding zone

Zone 1 is sometimes flooded, but usually above the normal water level.

This zone is inundated by floodwaters that quickly recede in a day or less. Key landscaping objectives may be to stabilise steep slopes and establish low maintenance natural vegetation.

Zone 2 Bog zone

Apart from periods in the summer, the soil is saturated

This encompasses the pond or wetland shoreline. The zone includes the safety bench and may also be periodically inundated if storm events are subject to extended detention. Plants may be difficult to establish in this zone, as they must be able to withstand inundation of water during storms or occasional drought during the summer. These plants assist in shoreline stabilisation and shading the shoreline, contaminant uptake and limiting human access. They also have low maintenance requirements.

Zone 3 0 - 150 mm deep of normal pool depth

This is a transition zone between the bog zone and the 150 - 500 mm ponded depth in which the water level sometimes drops and the area becomes a bog. Plants in this area must be able to tolerate periodic (but not permanent) saturated soil conditions.

Zone 4 150 - 500 mm deep

This is the main zone where wetland plants will grow in stormwater ponds and wetlands. Plants must be able to withstand constant inundation of water and enhance contaminant uptake.

Plants will stabilise the bottom and edge of the pond, absorbing wave impacts and reducing erosion. They will slow water velocities and increase sediment deposition rates along with reducing resuspension of sediments.

Zone 5 500 - more than 1000 mm deep

This zone is not generally used for planting because there are not many plants that can survive and grow in this zone.

10.5.2 Infiltration and filter devices

Infiltration and filter devices either take advantage of existing permeable soils or create a permeable medium such as sand. When properly planted, vegetation will thrive and enhance the functioning of the devices. For example, pre-treatment buffers will trap sediments. Successful plantings provide aesthetic value and wildlife habitat, making the facilities more acceptable to the general public.

Permeable paving on a library parking lot



Planting around infiltration or rain garden devices for a 5 - 10 metre distance will cause sediments to settle out before entering the device, thus reducing the frequency of maintenance cleanout. As a planting consideration, areas where soil saturation may occur should be determined so that appropriate plants may be selected. Shrubs or trees must not be planted in areas where maintenance access is needed.

Plant material selection should be based on the goal of simulating a terrestrial forested community of native species. Bioretention simulates an upland-species ecosystem. The community should have trees and a distinct community of understory shrubs and herbaceous materials. By creating a diverse, dense plant cover, a bioretention device will be able to treat stormwater runoff and withstand urban stresses from insects, disease, drought, temperature, wind and exposure.

10.5.3 Swales and filter strips

Key considerations include:

- Soil characteristics
- Plant interaction
- Effects on stormwater treatment, and
- Riparian buffers.

The characteristics of the soil are perhaps as important as device location, size, and treatment volume. The soil must be able to promote and sustain a robust vegetative cover.

Plant interaction is also important. Planting woody vegetation next to a swale or filter strip may shade the swale and allow intolerant grass species to grow in it.

The landscape plan will have to consider the effects that overall landscaping will have on stormwater treatment.

Riparian buffers are an excellent example of filter strips with high ecological, water quality and aesthetic value. When appropriately designed, they can treat dispersed runoff from adjacent land. The buffer, as shown in the adjacent image, can be an amenity to the community and increase economic value of adjacent lands.

Swale treating road runoff



Riparian buffer as an attractive amenity to the stream



10.5.4 Green roofs

Green roofs have to function in very exposed, rapidly changing weather conditions. A healthy, dense plant coverage is essential to successful stormwater management function. The plants must:

- Thrive in conditions that many plants would struggle to survive in as opposed to actually thriving in.
- Underpin permeability rates by water uptake and evaporation.
- Protect the filter media from erosion by having dense plant coverage of the roof.

The plants must have:

- Low maintenance requirements
- The ability to exist in wet and dry periods
- Resistance to high, gusty winds, and
- Be able to exist in full sunlight with a wide range of temperature conditions.

Green roof at the Auckland Botanic Gardens



11 Proprietary devices and innovative products

11.1 Introduction

As the stormwater programme continues to mature, alternative technologies will be proposed to meet water quality design goals. These innovative products may be developed where site or catchment development intensity make it difficult to achieve desired water quality treatment levels with conventional systems, or provide a level of treatment that is not possible with conventional approaches.

Waikato Regional Council encourages the development of innovative, cost-effective stormwater management technologies, subject to approval. Approval will depend on submission of objective, verifiable data that supports the claimed efficiency, although a single pilot site may be approved for purposes of data collection to document performance. Another avenue that is available for approval purposes is submission of performance information that has been certified through one of the overseas approval processes discussed later in this section.

Innovative products tend to be new technologies that have not been evaluated using approved protocols, but for which preliminary data indicate that they may provide a desirable level of stormwater contaminant capture. Some innovative products have already been installed or are proposed in the Region as parts of treatment trains or as a stand-alone device for a specific project. In some cases, innovative products may be necessary to remove metals or hydrocarbons. Innovative products can also be used for retrofits and where land availability does not permit larger conventional devices.

11.2 Approval options

There are two potential avenues that an innovative product can take to determine the extent of its use for stormwater quantity or quality function.

1. Submission of an approval that has been given through another certification process (as detailed in Section 11.2.1).
2. Submission of information as detailed in the rest of this section.

The preferred option is submission of an approval that has been given through another certification process. There are several processes listed in the next section and particularly the processes in Switzerland and two processes discussed from the United States are the most desirable and evidence of approval through those processes will form the basis of acceptability in the Waikato Region. Waikato Regional Council does maintain the right to not accept a specific certification if the source is not generally recognised by the engineering community as being objective or comprehensive.

Only when no certification is available from those sources listed in the next section should a manufacturer request approval to conduct local testing as detailed in Sections 11.2.2 – 11.4. If a device has been developed in an area that has a certification process and the manufacturer has declined the option to go through that process, the manufacturer shall detail to Waikato Regional Council why that device was not submitted through the appropriate certification process.

11.2.1 Approval through another certification process

Austria, Germany, Switzerland and the United States have all developed comparatively successful stormwater quality treatment evaluation protocols, which address the requirements of their legislative authorities and the needs of their national stormwater industries with respect to the accepted use of new and existing treatment devices.

Their protocols and rationale are provided in the following subsections.

11.2.1.1 Germany

There is no legally binding federal law in Germany for the discharge of stormwater runoff into surface water. All German states handle the treatment purposes differently according to their own State Water Laws and regulations. Legislation is being updated for soil and groundwater protection and should be completed by 2018 that will provide distinct threshold values that must be met by all stormwater quality treatment devices. In addition, recent regulations of the European Union must be addressed in the future.

Currently, there is no unified approach to evaluating the effectiveness of stormwater management treatment devices.

11.2.1.2 Austria

There are a variety of Standards and guidelines in Austria dealing with different runoff area types (trafficable areas, copper and zinc roofs) and this increases the effort involved with the planning and construction of stormwater quality management devices. Review and evaluation is a complicated process and cannot be undertaken easily or quickly to reflect new changes in science or practical knowledge.

As the test procedures have only recently been developed, no certifications exist to date.

11.2.1.3 Switzerland

The Swiss Federal Roads Office developed criteria to evaluate the performance of stormwater quality treatment devices used to treat road runoff. These evaluation criteria include maximum effluent concentrations discharging into receiving waters, removal efficiencies, specific surface loadings and hydraulic performances. The evaluation criteria also have a ranking system where 5 is the best performing and 1 is worst performing.

Evaluation criteria for water quality treatment devices in Switzerland are provided in Table 11-1.

Table 11-1: Evaluation criteria for water quality treatment devices in Switzerland¹⁵⁴

Rank	Hydraulic perf. (L/m ² /min)	Specific surface loading (m ² /m ²)	TSS (mg/L)	Effluent Concentrations			Removal Efficiencies		
				Cu (µg/L)	Zn (µg/L)	PAH* (µg/L)	TSS (%)	Cu (%)	Zn (%)
5	>8	>400	<10	<5	<10	<0.1	>90	>90	>90
4	4	200	20	10	20	0.2	80	80	80
3	2	100	30	15	30	0.3	70	70	70
2	1	50	40	20	40	0.4	60	60	60
1	<1	<50	>40	>20	>40	>0.4	<60	<60	<60

* Polycyclic Aromatic Hydrocarbons

11.2.1.4 United States

There are several regional certification programmes that exist in the United States and there are several other efforts underway to develop a more national approach to certification of water quality treatment devices. The two existing programmes are the following:

- Technology Assessment Protocol Ecology (TAPE), and
- Technology Acceptance Reciprocity Protocol (TARP).

Technology Assessment Protocol Ecology

The TAPE programme was established by Washington State Department of Ecology in 2000 to address concerns that claims regarding stormwater quality treatment devices were not actually meeting the State's criteria for TSS removal (80%). There are three use designations, all of which require field testing:

¹⁵⁴ Steiner et al, 2010

- Pilot level testing that requires laboratory scale based evidence. At this level the manufacturer is allowed to install water quality treatment devices at five sites and provide monitoring to verify that the device meets performance goals.
- Conditional Level Designation where the manufacturer must present both laboratory and substantive field data that may not meet full monitoring protocols. If granted then 10 sites are allowed for field monitoring to demonstrate the technology meets the performance goals.
- General Use Level Designation, which allows for unlimited use of the technology assuming it meets both the protocol and performance goals. This stage results in a certification letter, which stipulates the specific design criteria, performance limits and maintenance guidelines for the practice.

Approved technologies are then posted on the Department of Ecology's website which has 79 entries¹⁵⁵.

Technology Acceptance Reciprocity Protocol

This TARP protocol was originally a consortium of six states (California, Massachusetts, Maryland, New Jersey, Pennsylvania and Virginia) that worked together to establish the protocols. The protocols have two tiers of review:

- Technology Evaluation Engineering Report (TEER 1) that used an established laboratory protocol, and defined particle size distributions of surrogate sediment for hydrodynamic separators and filters.
- Technology Evaluation Engineering Report (TEER 2) that provided a protocol for field testing to demonstrate a removal of 80% TSS for filters and 50% TSS removals for hydrodynamic separators.

This protocol requires that the manufacturer must present a Quality Assurance Project Plan (QAPP) for review and approval. If accepted, the manufacturer moves to a test phase with an independent observer. If not accepted, changes are negotiated with the New Jersey Corporation for Advanced Technologies (NJCAT). If not resolved, an independent review is conducted by selected academic sources. Once the testing is complete a draft finding report is published by NJCAT. This report is placed for public comment, which includes other manufacturers. After the public comment period, changes are made if all comments are addressed and resolved. If not resolved then there is another opportunity for independent review. Once the report is finalised, it is issued as a verification and then can be used for certification by the State of New Jersey Department of Environmental Protection or other jurisdictions that recognise this process¹⁵⁶.

11.2.1.5 Auckland and Australia

The Auckland Regional Council developed a proprietary devices evaluation protocol to provide a framework for the evaluation of the performance of water quality treatment devices. However that protocol has been withdrawn and will no longer be used.

In Australia the primary stormwater industry body (Stormwater Australia) has formed an advisory committee to develop a protocol to provide guidance and a framework for the testing, evaluation and certification of the performance of new and existing stormwater quality devices. That process is in a detailed revision and development phase but has not yet been formally adopted. Once the protocol is adopted Waikato Regional Council will evaluate it and accept the certification results if the protocol is considered acceptable.

11.2.2 Information submission to Waikato Regional Council

This part outlines the information that should be submitted to evaluate the performance of alternative technologies whose operating parameters have not yet been verified to the satisfaction of Waikato Regional Council.

¹⁵⁵ Ecology, 2016

¹⁵⁶ State of New Jersey Department of Environmental Protection, 2016

This section deals with stand-alone and pre-treatment/retrofit devices.

11.2.2.1 Stand-alone devices

An innovative device should not be used for new development sites unless there are data indicating that its performance is expected to be reasonably equivalent to that provided by conventional devices, or as part of a treatment train. In retrofit situations, the use of any devices that make substantial progress toward the specified environmental objectives is encouraged.

Any alternative stand-alone device must generally comply with Waikato Regional Council water quality recommendations. Devices that rely on stormwater flowing through them (in this case proprietary devices) that rely on flow rate should be based on 10 mm/hour. This will ensure that approximately 90% of storms are treated.

Specific contaminant issues may warrant use of an alternative system that may be less effective at TSS reduction while providing enhanced reduction in other contaminants such as hydrocarbons or nutrients. Performance at specific contaminant reduction will be monitored appropriately.

Water quantity issues may also affect device acceptance, depending on location in a catchment.

11.2.2.2 Pre-treatment or retrofit

Individual devices that are not capable of providing desired water quality treatment may nevertheless play a useful pre-treatment supplementary role together with other approved stand-alone devices.

A device proposed for pre-treatment of flows into another device may, for example:

- Remove coarse sediments, in order to reduce the frequency of maintenance of the primary stormwater treatment practice
- Provide water quantity control, and
- Reduce stream erosion.

Retrofit of a site or catchment for water quality treatment depends on land availability, specific contaminants of concern and cost. Water quality goals must be tempered by what can realistically be accomplished in a catchment. It is in these situations where innovative products have a potentially significant role to play.

11.3 Information requirements

Innovative systems are being introduced internationally on a routine basis. Current ones include:

- Storm drain inserts,
- Underground vaults,
- Filter media flow through systems,
- Hydrodynamic structures, and
- On-line storage in the storm drain network.

This subsection summarises the basic information that should be submitted with any request for approval in a specific application in order to promote consistency in the submission of information for approval of an innovative practice. Consistency provides surety for a product manufacturer, a consent applicant and the general public that implementation of an innovative device is based on the best information available. The ultimate goal is clean water and implementation should be based on an estimation of the best device being used in a given situation.

It is important to be cautious with using innovative technologies for new development and retrofits. Before selecting an innovative product for a limited application, available information should be evaluated using an acceptable protocol.

For these reasons, submission of an innovative product in a given situation or for general compliance should include a description of the innovative technology or product including:

- Whether the operating parameters of the system have been verified
- Existing or proposed monitoring data (detailed in Section 11.4)
- Documentation of processes by which TSS and other contaminants will be reduced (physical, chemical, biological)
- Documentation and/or discussion of potential causes of poor performance or failure of the practice
- Key design specifications or considerations
- Specific installation requirements
- Specific maintenance requirements
- Data to support the claimed TSS removal efficiency. If the technology is new or the existing data is not considered reliable, a detailed monitoring programme to assess the TSS removal may be required, and
- Ownership issues that could influence use of innovative products on individual sites. Examples of this issue could be refusal of a territorial authority to accept responsibility for operation and maintenance.

11.4 Information required to determine adequacy of monitoring data

The following summarises the detailed information that is needed to properly judge the adequacy of existing or proposed monitoring data to evaluate performance compliance of an innovative practice, from catchment related information, device related information and water quality information.

11.4.1 Catchment parameters

The context in which the device operates helps define situations where an innovative product is (or is not) appropriate by assessing collection sites for known or new data. This in turn helps to determine the data's applicability to other locations.

It is also important that monitoring be undertaken in the field, as opposed to the laboratory, as field monitoring better reflects actual device performance.

Key catchment parameters include:

- Catchment area served
- % impervious area
- Total impervious area
- Hydraulic connectivity
- Base-flow or storm generated runoff only, and
- Catchment land use and expected contaminants.

11.4.2 Device design parameters

Detailing specific elements of the innovative device provides a clear understanding of the water quality treatment processes that occur in the various components of the device. If the device has a standard design that is based on catchment size or maximum flow rate, that information should be clearly stated in the discussion of device parameters as detailed in the general discussion.

Key device parameters include:

- Basic shape (length/width, volume, importance of local topography)
- Any permanent pool elevation and levels of service
- Surcharge elevation
- Forebay characteristics
- Inlet/outlet locations and relative elevations
- Water level control options
- 'On-line' or 'off-line'
- Age of device where monitoring has been or will be done, and
- Specifications for device components (filter media, sieve sizes, geotextile specifications, etc.).

11.4.3 Water quality analysis

Analyses detailed here are primarily for those undertaken in New Zealand. Recognising that many innovative proprietary devices are being developed overseas, all information may not be available. In those situations, a degree of judgement is involved regarding the relative importance of specified criteria. Waikato Regional Council will consider the submission of overseas data as full or partial fulfilment of the water quality analyses, depending on the applicability of the collected data to the region. Compliance assurance may necessitate water quality analyses on a limited basis only for those parameters where gaps exist.

The following analyses are to be undertaken for device performance documentation:

- Flow weighted composite samples used to determine the TSS concentrations in the influent and effluent of the device,
- General water quality constituents for monitoring include TSS, pH, conductivity, DO, enterococci and total hydrocarbons,
- Total zinc should also be monitored as a 'keystone' contaminant for trace metals,
- For devices claiming nutrient removal benefits, monitoring of TN and TP,
- The performance of the device or system should be based on the sampling results from at least 10 storms representative of those normally occurring in the Region. Depending on the relative variation in results, additional monitoring may be necessary to better understand expected performance,
- At least one storm event must be greater than 20 mm of rainfall,
- There must be at least three days of dry weather between storms sampled
- The samples must be collected and handled according to established procedures that are included in the monitoring plan,
- The laboratory selected for analysis of the samples is recognised as technically proficient,
- The efficiency of the device is calculated for individual events and is also based on the total TSS load removed for all monitored events,
- The monitoring must be conducted in the field as opposed to laboratory testing, and
- Depending on the processes involved in treatment, the device or system may need to be in the ground for at least six months at the time of monitoring.

11.5 Discussion

While the approval process or level of information requested may seem onerous to someone developing or wanting to use an innovative device, it is essential that programme implementation and overall success be underpinned by good technology. With millions of dollars being spent on design, implementation and operation, it is important that environmental objectives are met, especially when considering the costs associated with management.

Even if Waikato Regional Council accepts certification results for an individual product, local councils are not obligated to accept operational responsibility for them.

Ultimate programme success rests on stormwater strategies, approaches and devices achieving a certain level of performance. We must have confidence that a device will achieve stated goals and a good understanding of device strength, limitations, and performance if we are to meet our obligations under the RMA and public expectations.

12 Contaminant loads

12.1 Introduction

Stormwater management systems are designed to avoid, remedy and mitigate potential adverse effects associated with stormwater runoff from urban areas, relating to stormwater quantity and stormwater quality effects.

In terms of stormwater quantity, hydrological and hydraulic modelling can demonstrate that downstream flooding or channel erosion can be prevented or minimised through careful analysis and design. Water quality outcomes are less well defined and environmental outcomes are even more difficult to quantify.

The purpose of this section is to provide a means to calculate water quality loadings related to land use and to assess how implementation of stormwater management strategies and devices can reduce contaminant loadings to receiving systems.

Contaminant load analysis should be undertaken by the applicant as a component of the application submission. This approach ensures that the applicant has a good understanding of the relationship between urban land uses, contaminant loads and the reductions that stormwater devices can provide.

12.2 Determining water quality loads

There are a variety of approaches that have been developed in New Zealand and internationally. The most appropriate approach is the Auckland Council's Contaminant Load Model that will be discussed in the next section.

For the purposes of this guideline, contaminant load comparison is based on total suspended solids, zinc, copper and TPH loads. This analysis will involve calculation of the following:

- Total suspended solids, zinc, copper and TPH loads for the developed site without providing stormwater quality treatment, and
- Total suspended solids, zinc, copper and TPH loads for the developed site with the intended stormwater quality treatment.

While nutrient export may be a concern, there is little transferable international information to the Waikato region. While information is available on calculating nutrient loads its value in these comparisons provides little benefit, becomes more complicated to calculate and is not included in the analysis.

Therefore, contaminant load comparison is limited to total suspended solids, zinc, copper and TPH to determine loadings from various urban land uses and the beneficial effect that implementation of stormwater practices will have on contaminant discharges.

12.3 Auckland Council's contaminant load model

This model, Version 2.0, is a spreadsheet model that has been developed to calculate contaminant loads within a catchment for the following contaminants:

- Total suspended solids (TSS)
- Zinc
- Copper, and
- Total petroleum hydrocarbons (TPH).

The model provides contaminant yields (grams/m²/per annum) and uses data collected for the Auckland Region that has been validated nationally and internationally. The model also inputs

relevant removal efficiencies for various stormwater devices to provide a barometer on how much of a given contaminant can be removed by a given device¹⁵⁷.

It is a good simple method that provides annual estimates of contaminant loads from various land uses. There are several issues that would need to be considered if the method is to be used in the Waikato Region.

1. In developing their unit loadings that are derived from event mean concentrations, there is an assumption, which is reasonable for the Auckland Region, that annual impervious surface runoff throughout the region is 1,000 mm per annum. The original study that the unit loadings are based on¹⁵⁸ used 1,200 mm of rainfall, with an assumption that the rainfall will result in 1,000 mm of runoff. The Waikato Region rainfall varies greatly as the region is traversed so this assumption is less accurate depending on location in the region. Figure 9-37 shows annual rainfall throughout the region and the relative differences in rainfall can be seen.
2. The contaminant loads used as unit loadings for pervious areas account for slope but not soil type other than sedimentary, volcanic and unknown. Auckland soils in most areas are silty clay or clay soils so not accounting for soil permeability is not a problem but the Waikato Region has a large variety of soils, which may significantly influence loadings.
3. The source types are very detailed with considerable information being required regarding impervious surfaces for roads (including vehicles/day information) and impervious surfaces other than roads. There are forty parameters that may need information entry to obtain annual contaminant yields in addition to inputting the variety of treatment devices that will be used for the various land uses. Slopes have to be carefully considered where each source is concerned.

Unit loadings of metals and TPH are reasonable for use in the Waikato Region but sediments and pervious areas may need modification to loadings if more accuracy is required.

Rather than identify all forty of the unit loadings, it is suggested that the source document be reviewed.

12.4 Recommended approach

There are two issues that need to be considered when using approaches that have been developed elsewhere.

- The difference in annual rainfall, and
- Consideration of local soils.

The issue of contaminant reductions via implementation of stormwater strategies and devices is not considered significant as there is general agreement, with only some variation, hence is not discussed further.

12.4.1 Rainfall differences

The annual loadings for urban land use for the Auckland Region are considered good loading estimates, however they are based on an assumption of a uniform impervious surface runoff of 1,000 mm (based on 1,200 mm of rainfall). Rainfall in the Waikato Region has greater variability and needs to be accounted for in estimating annual loads.

As a result, the contaminant yields from the Auckland contaminant load model should be modified by the ratio of average annual rainfall for the site in millimetres (derived from Figure 8-35) divided by 1,200 mm.

¹⁵⁷ Auckland Regional Council, 2010

¹⁵⁸ Kingett Mitchell et al, 2003

As an example, a project in Hamilton having an average annual rainfall of 1,300 mm would use a ratio of 1.1 (1,300 mm / 1,200mm = 1.1). Hence would multiply the contaminant yields from the Auckland contaminant load model by a ratio of 1.1 to more accurately reflect the difference in local area runoff.

Table 12-1 provides urban contaminant yield values for a variety of land uses in the Waikato Region.

The values in Table 12-1 have come from the Auckland contaminant load model discussed above but have been converted from g/m²/year to kg/ha/year. It should be noted that no TPH values were provided for land uses other than roads.

Table 12-1: Urban contaminant yields for use in the Waikato Region

Land use	Specific elements	Contaminant yield (kg/ha/year)			
		Total suspended solids (TSS)	Total zinc	Total copper	TPH
These values need to account for rainfall variation					
Roofs	Galvanised steel	50	22.4	0.003	0
	Zinc/aluminium	50	2.0	0.009	0
	Zinc/aluminium coated	50	0.2	0.016	0
	Concrete	160	0.2	0.033	0
Roads	< 1k vpd	210	0.044	0.015	0.335
	1k-5k vpd	280	0.26	0.089	2.013
	5k-20k vpd	530	1.1	0.37	8.387
	20k-50k vpd	960	2.57	0.86	19.474
	50k-100k vpd	1580	4.7	1.57	35.645
Paved	Residential	320	1.95	0.36	0
	Industrial	220	5.9	1.07	0
	commercial	320	-	0.03	0
Pervious	Urban grassland and trees < 5 ^o slope	450	0.016	0.003	0
	Urban grassland and trees Slope 5-10 ^o	920	0.032	0.006	
	Urban grassland and trees Slope >10 ^o	1850	0.065	13	

Due to the rainfall variation between the Auckland and Waikato regions discussed above, the values provided in Table 12-1 need to be modified to account for rainfall variation by the appropriate ratio that takes into account the local average rainfall and divides it by 1,200mm.

The rainfall ratio should be used for all of the urban land uses for total suspended solids, zinc, copper and TPH.

This value is then multiplied by the unit loading times the area of the land use in hectares.

To use the tables and determine contaminant loading, undertake the following steps:

1. Determine the appropriate land use for a given site and take the values for the contaminants given in Table 12-1 to use for subsequent calculations.

2. Find the site location in the region in Figure 8-35 and determine the rainfall ratio (ratio = local average annual rainfall / 1,200 mm)
3. Multiply the rainfall ratio and the unit loadings for total suspended solids, zinc, copper and TPH to get the local unit loadings for the site.
4. Multiply the unit loadings from the previous step by the area of the land use in hectares to get the site loadings.
5. To get the loadings that are discharged from the site, the loading must account for the stormwater management devices that are used to treat the site runoff. Refer to Table 6-13 for contaminant removal rates for different devices. Use this table to determine the percentage reduction of the contaminants of concern. The percentages given in the tables are multiplied by the site loadings to obtain site contaminant discharges.

12.4.2 Local soils

It is not necessary to take local soils into account in an urban context for several reasons.

1. Most urban sites have a reticulation system such that local soils are often bypassed in transport of stormwater runoff.
2. Soils are often highly disturbed and quantifying their capability of contaminant reduction is questionable.

In those areas where rural land uses are included in an analysis, soils should be incorporated into the analysis for total suspended solids, zinc and copper.

12.4.3 Case study – Contaminant load model

Residential subdivision in Taupo

Rainfall at site location = 1100 mm
 Subdivision size = 8 ha
 Average lot size = 470 m²
 Average home roof area = 250 m² (2.5 ha across the whole site)
 Subdivision imperviousness = 60% (4.8 ha)
 Residential roads (1k-5k) = 2.3 ha
 Pervious areas = 3.2 ha
 Roof material is zinc/aluminium surfaces steel coated long run

Ratio of Taupo rainfall versus 1200 mm = 1100/1200 = 0.92

Stormwater treatment is provided by bioretention for all roof areas; paved areas and pervious surfaces are treated with swales.

Table 12-6 shows how total site loads are calculated. Removal efficiencies are those shown in Table 6-13. Total loads could have additional removal if peak flow control is required for the subdivision and a constructed wetland provides peak and flow control. Since all site runoff would go through the wetland, the total removals shown in the bottom row of the table can be reduced further.

Table 12-6: Case study: contaminant load model

Land use	Contaminant loads (kg/ha/year)			
	TSS unit load	Zinc unit load	Copper unit load	TPH
Loadings from roof (kg/ha/year)	46	0.2	0.01	0
Loadings from roof areas for site (kg/year)	115	0.5	0.025	0
Removal efficiency of bioretention	0.8 (20% discharged)	0.7 (30% discharged)	0.75 (25% discharged)	NA
Loadings from roof areas after bioretention (kg/year)	23	0.15	0.006	NA
Loadings from road areas (kg/ha/year)	257.6	0.052	0.08	1.85
Loadings from road areas for site (kg/year)	592.5	0.12	0.16	4.2
Removal efficiency of swales	0.75 (25% discharged)	0.5 (50% discharged)	0.6 (40% discharged)	0.4 (60% discharged)
Loadings from road areas after swale treatment (kg/year)	148	0.06	0.064	2.52
Loadings from pervious surfaces (kg/ha/year)	414	0.01	0.003	0
Loadings from pervious areas for site (kg/year)	1325	0.03	0.01	0
Removal efficiency of swales	0.75 (25% discharged)	0.5 (50% discharged)	0.6 (40% discharged)	0.4 (60% discharged)
Loadings from pervious areas after swale treatment (kg/year)	331	0.015	0.004	0
Total loads discharged from site prior to treatment (kg/year)	2032.5	0.65	0.195	4.2
Total loads discharged from site after treatment (kg/year)	502	0.225	0.074	2.52

Table 12-6 shows the removal capability of stormwater management devices for a variety of contaminants. It is stressed that even with the implementation of stormwater management devices contaminants are discharged from the site. Depending on the receiving system the cumulative impacts of numerous developments could be more than minor. Thus, there is need to also consider low impact design principles during the design and implementation of new developments.

12.5 Summary

The contaminant load model discussed in this section is to be used to assess the performance of a proposed stormwater management system. The contaminant load model provides a means to calculate water quality loadings related to land use and to demonstrate how implementation of stormwater management strategies and devices can reduce contaminant loadings to receiving systems.

The contaminant load model is to be used to assess two scenarios:

- The post-development scenario without treatment, and
- The post-developed scenario with treatment.

The findings of the assessment are to be provided as part of a consent application.

Part III: Different site applications for stormwater management

13 Industrial site management

Much of the information included in this section is from work undertaken for the Hawkes Bay Regional Council.

13.1 Introduction

Industrial sites are potentially significant sources of contamination to receiving systems. Their impact can be disproportional to their size as they may have significant storage of chemicals, have operations that involve a variety of chemicals and drainage systems that quickly convey the contaminants to receiving systems. Receiving systems are discussed in Section 5 and each of the receiving environments mentioned could be encountered on or near an industrial site.

Bin leaking paint into the stormwater system



Industrial sites also must continually guard against spillage of chemicals and protect storage areas from coming into contact with stormwater. As a safeguard they must develop and implement operational plans that are risk based to prevent adverse impacts to receiving systems. The following subsections provide a brief discussion of a number of issues related to the establishment and operation of an industrial activity.

The following items are discussed:

- Source control and site housekeeping,
- Industries, contaminants of concern and appropriate treatment devices, and
- Stormwater treatment for contaminant reduction and peak flow control.

Each of these items is a significant element in developing an effective site management plan and the elements need to be undertaken in conjunction with one another to minimise adverse impacts to receiving systems.

13.2 Source control and housekeeping

Initial consideration has to be given to source control and preventing discharge of contaminants in the first place. This can only be undertaken when there is a good understanding of site operations, areas potentially draining contaminants and the site drainage system. These items can be considered if there is an up-to-date site plan.

13.2.1 Importance of having site plans

A site plan has to be available that shows the following:

- Buildings
- All outdoor areas
- Site boundaries and adjacent land use, and
- Stormwater and wastewater systems.

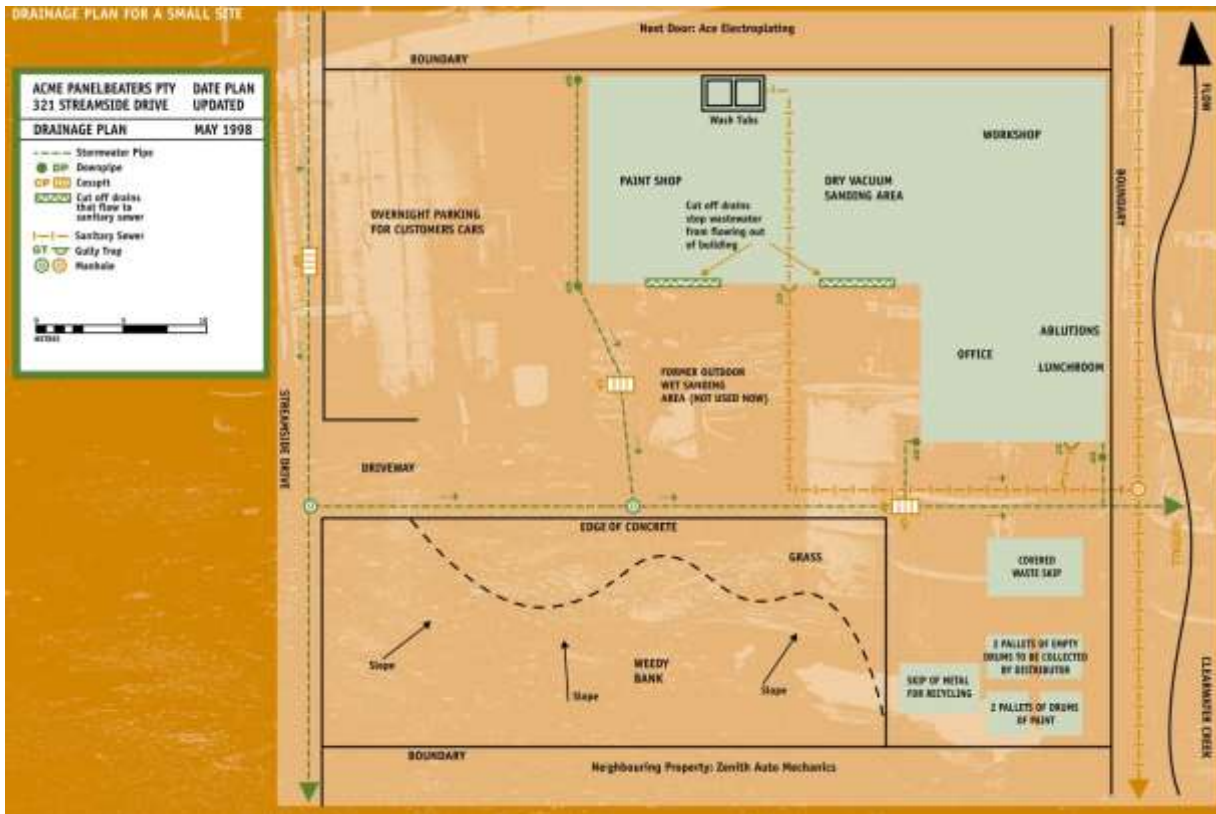

Figure 13-1: Typical industrial site showing various site elements¹⁵⁹

When considering the drainage plan, the following elements need to be considered as part of the drainage system.

- Stormwater pipes, their inlets and outlets,
- Any open drains,
- Direction of stormwater flows and overland flowpaths,
- Low points on the site,
- Areas where runoff leaves the site (ground or surface water),
- Stormwater management devices, and
- Any evidence of a cross-connection between the stormwater and wastewater system.

13.2.2 Stormwater pipes, their inlets and outlets

The site drainage system will discharge into one of three systems:

- A council reticulation system that will eventually outfall into a stream, lake, ground, estuary, harbour or open coast environment,
- A soak hole or general soakage into the ground, or
- An excavated ditch, stream, estuary, lake, harbour or open coast environment.

It is important to know what the eventual receiving system is in order to determine the potential impact of contaminants to that system.

¹⁵⁹ Hawke's Bay Regional Council, 2009

13.2.3 Outdoor areas

Spills and leaks from outdoor activities can easily get into the stormwater system. It is important to know where these activities drain to in the event of a spill. Examples of outdoor activities include:

- Loading and unloading areas,
- Decanting areas,
- Refueling and lubricating areas,
- Washdown areas,
- Permanent or temporary areas for storage of materials,
- Tanks and bunding,
- Stormwater monitoring devices,
- Stormwater shut off/diversion valves, or
- Stormwater treatment systems.

13.2.4 Stormwater and wastewater systems

Stormwater systems are those that accept surface runoff related to rainfall, while wastewater systems can include the following elements:

- Sanitary or trade waste sewers,
- Gully traps,
- Internal floor drains,
- Manholes, or
- Trade waste connections.

It is important to recognise that stormwater systems should not be used for wastewater disposal. Cross-connections are a major source of contaminant entry into stormwater systems.

Cross-connections can be a problem, especially for older sites where waste pipes are connected to the stormwater system. These can include:

- Boiler blowdown waters,
- Compressor condensates,
- Cooling water,
- Sewage,
- Trade wastes, and
- Wash waters.

If cross-connections are found, the issue should be discussed with the local council and the cross-connection should be disconnected as soon as possible by connecting the waste pipe to the sanitary sewer.

13.2.5 Housekeeping

Inspections can reveal housekeeping problems and any of the following items indicate the need for improved site housekeeping:

Degreasing where runoff can enter the stormwater system



- Stains or corrosion of any surface, including along concrete heading towards grates or around grates,
- Marks on or near any stormwater grate or stormwater cesspit or materials in the indicating that anything other than clean rain water has gotten into them,
- Stormwater grates that are blocked with solids like grass, plastic or litter,
- Puddles, discolouration, oil or grease or chemicals on the ground,
- Leaking or corroded equipment, valves, seals, containers or lines,
- Areas where absorbent materials (kitty litter, sawdust) have been used to clean up a spill but not properly removed,
- Outdoor bunds where stormwater valves have been left open or are not securely locked,
- Litter or waste thrown behind buildings, over fences, onto foreshore or river banks,
- Containers that are stored in the open that could contain residues, show signs of corrosion or leaks or torn bags,
- Leaks, overflows or spills from tanks, valves, pumps or drip trays,
- Containers unsafely stacked on top of each other or
- Containers that are not clearly labeled or not labeled at all.

Staining that indicates discharge of contaminants into the stormwater system



Wash-down areas are another source of contaminant discharge to receiving systems. Issues related to wash-down areas can include the following:

- Wash-down areas being routinely cleaned after washing to ensure that contaminants removed by the washing operation do not enter the stormwater system,
- Equipment being routinely maintained so that they do not produce excessive contaminants when washing is done, and
- Wash-down is undertaken in designated areas.

Loading, unloading, material handling and decanting areas are another source of contaminant generation and potential discharge. These areas need to be considered for contaminant generation with examples being the following:

- Spills caused by decanting liquids. This issue can be reduced by using funnels, drip trays, buckets or other devices to catch liquids,
- Checking drip trays routinely to ensure that they do not become overly full,
- Filling and transferring materials procedures, and
- Checking valves, pumps, flanges, seals, pipe connection points for bulk tanker deliveries for leakage.

Storage of funnels that minimise spillage during liquid transfer



Storage areas are another area that needs to be considered for contaminant generation. These can include:

- Raw materials/supply stores
- Dangerous goods stores
- Finished goods stores
- Other materials such as cleaning agents, detergents or weed killers.
- Metal drums and vessels, or
- Containers or bags.

A bunded refuelling tank

Bunded areas are areas where substantial quantities of chemicals are stored and have a protective bund around the storage area to capture chemicals in the event of a sudden rupture or leak releasing the chemicals. Bunds need to be sized appropriately (normally 110% of tanks storage volume) and routinely inspected and outlet valves tested with the inspection including the following:



- Valves
- Locks or other controls on valves
- Stains or leaks inside and around the bunds
- Crash barriers, and
- Pipework across roofs to prevent leakage into the stormwater drainage system.

Valves should be kept closed unless testing of stored liquids is undertaken to ensure no contaminant discharge prior to release of the liquids.

Refuelling, vehicle maintenance and oil storage areas are also potential sources of contaminant generation and potential discharge to stormwater systems. Contamination potential can be reduced through the following activities:

- Regularly cleaning around pumps, refuelling areas
- Lubrication materials, vehicle maintenance and oil storage being checked and cleaned as needed
- Checking and maintaining shut-off valves

- Routine maintenance of company vehicles to prevent leaks
- Proper storage of waste oil and routine removal of the waste oil from the site, and
- Radiator fluids disposed of as a trade waste.

Finally, underground and above ground storage tanks need to be carefully considered for the following:

- Tank labelling to show contents
- Procedures for filling tanks to minimise risk of overfill, drips or spills
- Inspection and maintenance of equipment, and
- Volume indicators that can be checked to ensure there is no leakage.

Above ground tanks are preferred over underground ones as it is best to see a problem when it arises. Underground tanks for chemical or contaminant storage should be avoided. Where their placement is necessary they should be double skin tanks and testing undertaken periodically to ensure that there is no leakage.

All of these activities constitute source control on industrial sites. While they may provide significant reductions in contaminant generation, they will not normally be adequate for effective site control. There will normally be a need for a stormwater management treatment system as an overlay.

The combination of source control in conjunction with implementation of stormwater quality treatment will provide the best outcome from a contaminant capture perspective.

13.2.6 Roofs

Further to the discussion provided in Section 6.2.3 about the contaminants that different roofing materials produce, for industrial areas it is important to carefully select roofing (and building) materials to avoid contaminant generating materials. In addition, discharge management from industrial activities will also need to include consideration of dry deposition of road dust and/or factory exhausts on roofs.

High zinc concentrations in the runoff in industrial areas can be due to dry deposition on roofs of road dust and/or factory exhausts (smoke stacks, extractor fans, etc.). High zinc and relatively high lead concentrations, together with detectable chromium and nickel shows that roofs in industrial sites have the potential to contribute very high concentrations of contaminants to stormwater runoff. Thus, effectively addressing stormwater runoff at industrial sites will require consideration of roof runoff water quality as well as yard practices and associated runoff water quality. Error! Bookmark not defined.

Contaminant discharge potential will generally be activity and location specific and requirements to treat industrial roof runoff will be industry specific. Any stormwater diversion and discharge consent application for an industrial activity must provide information related to potential deposition of contaminants from dry deposition on roof areas. Based on this information, council will determine the need for water quality treatment of roof runoff.

13.3 Industries, contaminants and treatment devices

The following table provides a detailed listing of industries, the contaminants that they generate, the likelihood that those contaminants will be released into the environment and the types of stormwater devices that can be used to reduce the level of a given contaminant from being discharged.

Table 13-1: Industrial activities contaminants and treatment processes

Industrial Activity	Description of Trade	Contaminants of Concern	Likelihood of Release	Treatment Processes
Wood or paper product storage, manufacturing or fabrication	Treated timber storage	Copper (Cu), Chromium (Cr), Arsenic (As), Total Suspended Solids (TSS)	High	Settling, sand/peat filter
Wood or paper product storage, manufacturing or fabrication	Timber treatment	Cu, Cr, As, Tin (Sn), TSS, Oil and Grease, pesticides	High	Sand/peat filter
Transport and related activities	Boat or ship construction, repair or maintenance	Cu, Zinc (Zn), TSS, Oil and Grease	High	Settling, oil/water separator, sand/peat/carbon filter
Research or defence	Naval and air force defence activities	Metals, pesticides, oil and grease	High	Settling, , oil/water separator, sand/peat/carbon filter
Research or defence	Research establishments	Depends on specific materials being used or stored	Less than 1000 m ² - Low	Treatment depends on materials being used or stored
		Depends on specific materials being used or stored	More than 1000 m ² - Medium	Treatment depends on materials being used or stored
Research or defence	Motor vehicles or parts	Oil and grease, TSS, Metals	Less than 1000 m ² - Low	Sand/peat/carbon filter
			1000 m ² to 5000 m ² Medium	
			More than 5000 m ² - High	
Recycling, recovery, re-use or disposal	Metals (crushing, grinding, sorting or storage)	Oil and grease, TSS, Zn, Cu, Lead (Pb), Cadmium (Cd), Cr	High	Oil/water separator, sand/peat/carbon filter
Recycling, recovery, re-use or disposal	Automotive dismantling	Oil and grease, TSS, particulate metals, Zn, Cu, Pb, Cd, Cr	High	Coarse settling, oil/water separator, sand/peat/carbon filter
Recycling, recovery, re-use or disposal	Waste transfer stations	Gross Particulates (GPs), TSS, Chemical Oxygen Demand (COD), Metals, Oil & Grease, residual organic compounds	High	Sand/peat/carbon filter
Recycling, recovery, re-use or disposal	Chemicals	Iron (Fe), Aluminium (Al), pH, Nitrate (NO ₃) + Nitrite (NO ₂), Metals, Organics	Low	Sand/peat/carbon filter
Recycling, recovery, re-use or disposal	Batteries	Pb, pH	Low	Sand/peat filter, carbonate filter
Metal processing, metallurgical works or metal finishing	Processing of metals (smelting, casting)	Metals (Al, Pb, Zn, Cu, Fe), TSS, pH	High	Sand/peat/carbon filter
Metal processing, metallurgical works or metal finishing	Metal plating, anodising or polishing	Metals (Zn, Cu, Cr, Nickel (Ni), Silver (Ag)), pH, Cyanide	High	Peat filter
Transport and related activities	Marinas	TSS, Zn, Cu	Medium	Peat filter
Sewage treatment and handling	Sewage treatment plants	TSS, Biochemical Oxygen Demand (BOD), NO ₃ +NO ₂ , Ammonia (NH ₃), Pathogens	High	Settling, wetlands, disinfection
Sewage treatment and handling	Sewage solids storage	TSS, BOD, NO ₃ +NO ₂ , NH ₃ , Pathogens	Low	Settling, wetlands, disinfection
Rubber industries	Synthetic rubber manufacturing	Zn, TSS, organics	Medium	Wetlands

Industrial Activity	Description of Trade	Contaminants of Concern	Likelihood of Release	Treatment Processes
Recycling, recovery, re-use or disposal	Tyres	Zn, TSS	High	Sand/peat/carbon filter
Recycling, recovery, re-use or disposal	Chemical containers cleaning, reconditioning or recycling	Metals, COD, NO ₃ + NO ₂	Medium	GPT screen, coarse settling, oil/water separator, oxidation sand/peat/carbon filter
Recycling, recovery, re-use or disposal	Waste transfer stations	GPs, TSS, COD, Metals, Oil & Grease, residual organic compounds	Medium	GPT screen, coarse settling, oil/water separator, oxidation, sand/peat/carbon filter
Recycling, recovery, re-use or disposal	Non-metal recycling (composting, glass, paper or paper board)	TSS, COD, NO ₃ + NO ₂ , pathogens	High	Wetlands + oxidation
Recycling, recovery, re-use or disposal	Crushing, grinding or separation works (other than sand, gravel, rock or mineral - e.g. slag, road base, demolition material)	TSS, pH, Zn	High	Sand/peat filter, wetlands
Recycling, recovery, re-use or disposal	Landfills	Metals, TSS, BOD, NO ₃ +NO ₂ , NH ₃ , organics	High	Coarse settling, oil/water separator, oxidation, sand/peat/carbon filter
Recycling, recovery, re-use or disposal	Chemicals	Fe, Al, pH, NO ₃ +NO ₂ , metals, organics	Low	Sand/peat/carbon filter
Recycling, recovery, re-use or disposal	Batteries	Pb, pH	Low	Sand/peat filter, carbonate filter
Product storage or handling centres	Bulk chemicals	Al, Fe, Zn, NO ₃ +NO ₂	Medium	Sand/peat/carbon filter
Petroleum or coal product manufacturing	Coal products	TSS, Al, Fe, pH	Medium	Settling, wetlands
Non-metallic mineral product manufacturing	Cement, lime, plaster and concrete products	TSS, Fe, pH, Oil and Grease	High	Settling, wetlands
Non-metallic mineral product manufacturing	Concrete batching plants (ready mixed concrete)	TSS (lime), pH	High	Settling, wetlands
Motor vehicle services facilities	Mechanical servicing of motor vehicles	Oil and grease, metals	High	Sand/peat/carbon filter
Motor vehicle services facilities	Service stations	Oil and grease, Polycyclic Aromatic Hydrocarbon (PAH), BTEX*, TSS	High	Oil/water separator, sand filter, oxidation
Metal processing, metallurgical works or metal finishing	Refinement of ores	TSS, metals	Medium	Settlement, wetland
Metal processing, metallurgical works or metal finishing	Metal blasting or coating (excluding spray painting)	Zn, other metals, TSS	High	Sand/peat filter
Electronics	Circuit board manufacturing (excluding assembly only)	Metals (Zn, Cu, Cr, Ni), pH, organics	High	Sand/peat filter
Commercial livestock processing centres	Tanneries and Fellmongeries	BOD, oil and grease, sulfides, Cr, Nitrogen (N)	High	Oil/water separator, oxidation, peat filter
Chemical and associated product manufacturing	Fungicides, herbicides, pesticides, timber preservatives and related products	COD, pH, As, Cu, Cr, Pesticides	Medium	Sand/peat/carbon filter

Industrial Activity	Description of Trade	Contaminants of Concern	Likelihood of Release	Treatment Processes
Chemical and associated product manufacturing	Batteries	Pb, pH	Medium	Sand/peat filter, carbonate filter
Chemical and associated product manufacturing	Paint, pigment, inks and dyes	Al, Zn, Fe, COD, organics	Medium	Sand/peat/carbon filter
Chemical and associated product manufacturing	Acids, alkalis or heavy metals	pH, TSS, metals	Medium	Sand/peat/carbon filter, carbonate filter
Transport and related activities	Railway workshops or refuelling depots	Oil and grease, TSS, COD, Zn	Medium	Settlement, sand/peat filter
Transport and related activities	Road freight transport depot (bulk chemical)	Oil and grease, TSS, COD, Zn, organics	Medium	Sand/peat/carbon filter, oxidation
Transport and related activities	Truck refuelling facilities (non-service station)	Total Petroleum Hydrocarbon (TPH), PAH	Medium	Sand/peat filter
Transport and related activities	Shipping container reconditioning	Oil and grease, TSS, COD	Medium	Oil/water separator, Settlement
Rubber industries	Tyre manufacturing or retreading	Zn, TSS, organics	Medium	Sand/peat filter
Recycling, recovery, re-use or disposal	Oil, petroleum hydrocarbon wastes	Oil and grease, PAH, BTEX	Medium	Oil/water separator, sand/carbon filter
Recycling, recovery, re-use or disposal	Sewage solids treatment or storage facilities	TSS, BOD, NO ₃ +NO ₂ , Pathogen	High	Retention, oxidation
Recycling, recovery, re-use or disposal	Hazardous materials storage or treatment	TSS, COD, Metals, Oil and Grease, organics	High	Sand/peat/carbon filter
Product storage or handling centres	Bulk hydrocarbons (non-service stations)	Oil and grease, PAH, BTEX	Medium	oil/water separator, sand/peat/carbon filter
Power	Gas, coal or liquid power generation	Oil and grease, Zn, TSS	Medium	oil/water separator, wetlands
Power	Electrical substations	Oil and grease	medium	Sand filter
Petroleum or coal product manufacturing	Bitumen/asphalt premix or hot mix	TSS, Zn, TPH	Medium	oil/water separator, Sand/carbon filter
Animal feedstuffs	Pet food manufacture	BOD	Medium	Sand/peat filter, swales
Agriculture support industries	Inorganic fertiliser manufacture, storage or handling	COD, TSS, Pb, Fe, Zn, Phosphorus (P)	Medium	Sand/peat filter, high plant surface area and soil organics
Wood or paper product storage, manufacturing or fabrication	Log storage yards (outside of forested areas)	TSS, COD, NO ₃ +NO ₂	High	Wetlands
Chemical and associated product manufacturing	Synthetic resins	TPH, pH, Zn	Low	Sand/peat filter
Chemical and associated product manufacturing	Solvents	TPH	Low	Sand filter
Chemical and associated product manufacturing	Explosives and pyrotechnics	Metals (Pb, Zn), Volatile Organic Carbons (VOCs)	Never Low	Sand/peat/carbon filter

Industrial Activity	Description of Trade	Contaminants of Concern	Likelihood of Release	Treatment Processes
Wood or paper product storage, manufacturing or fabrication	Particle board or other wood panel manufacturing	TSS, COD, NO ₃ +NO ₂ , oil and grease	Medium	GPT, Settling, sand filter
Wood or paper product storage, manufacturing or fabrication	Pulp, paper or paper board manufacturing	TSS, COD, NO ₃ +NO ₂ , oil and grease, Zn	Medium	Wetlands, oil/water separator
Wood or paper product storage, manufacturing or fabrication	Plywood or veneer manufacturing	TSS, COD, NO ₃ +NO ₂ , organics	Medium	Wetlands
Transport and related activities	Shipping, loading/unloading	Oil and grease, TSS, COD	Medium	Oil/water separator, sand/peat filter
Transport and related activities	heliports	Oil and grease, TSS, COD		Oil/water separator, sand/peat filter
Transport and related activities	Road freight transport depot (non-chemical) with mechanical servicing	Oil and grease, TSS, metals	Never High	Oil/water separator, sand/peat filter
Petroleum or coal product manufacturing	Petroleum refining	Oil and grease, PAH, BTEX	Medium	Oil/water separator, sand/carbon filter
Petroleum or coal product manufacturing	Petroleum hydrocarbon, oil or grease manufacturing	Oil and grease, PAH, BTEX	Never Low	Oil/water separator, sand/carbon filter
Non-metallic mineral product manufacturing	Glass	Oil and grease, BOD, TSS	Medium	Oil/water separator, sand/peat filter
Metal product manufacturing	Sheet and structural metal products	Fe, Al, Zn	Medium	Sand/peat filter
Machinery or equipment manufacturing	Other machinery or equipment	Oil and grease, Fe, Al, Zn	Medium	Sand/peat filter
Machinery or equipment manufacturing	Industrial machinery or equipment	Oil and grease, Fe, Al, Zn	Medium	Sand/peat filter
Food or beverage manufacturing or handling	Vineyards or wine manufacturing	BOD, TSS, oil and grease, N	Medium	Oil/water separator, high plant activity and surface area
Food or beverage manufacturing or handling	Processed dairy foods manufacturing	BOD, TSS, oil and grease, N	Medium	Oil/water separator, high plant activity and surface area
Food or beverage manufacturing or handling	Oil or fat product manufacturing or handling	BOD, TSS, oil and grease, N	Medium	Oil/water separator, high plant activity and surface area
Food or beverage manufacturing or handling	Meat and meat product manufacture (including fish)	BOD, TSS, oil and grease, N	Medium	Oil/water separator, high plant activity and surface area
Food or beverage manufacturing or handling	Processed dairy foods handling	BOD, TSS, oil and grease, N	Medium	Oil/water separator, high plant activity and surface area
Food or beverage manufacturing or handling	Other foodstuffs handling	BOD, TSS, oil and grease, N	Medium	Oil/water separator, high plant activity and surface area
Food or beverage manufacturing or handling	Meat product handling (including fish)	BOD, TSS, oil and grease, N	Medium	Oil/water separator, high plant activity and surface area
Food or beverage manufacturing or handling	Beverages or malt product handling	BOD, TSS, oil and grease, N	Medium	Oil/water separator, high plant activity and surface area

Industrial Activity	Description of Trade	Contaminants of Concern	Likelihood of Release	Treatment Processes
Food or beverage manufacturing or handling	Bakery product handling	BOD, TSS, oil and grease	Medium	Oil/water separator, high plant activity and surface area
Commercial livestock processing industries	Slaughter	BOD, oil and grease, N	Medium	Oil/water separator, high plant activity and surface area
Commercial livestock processing industries	Manufacture, store or handle products derived from animal slaughter (gelatin, fertiliser or meat products)	BOD, oil and grease, N	Medium	Oil/water separator, high plant activity and surface area
Commercial livestock processing industries	Scouring or carbonising greasy wool or fleeces	BOD, oil and grease, N	Medium	Oil/water separator, oxidation
Commercial livestock processing industries/centres	Rendering or fat extraction	BOD, oil and grease	High	Oil/water separator, oxidation
Chemical and associated product manufacturing	Other chemical products (plastic manufacturing)	pH, TSS, Zn, N	Low	Sand/peat filter
Chemical and associated product manufacturing	Polishes, adhesives or sealants	BTEX, pH, Zn	Low	Sand/peat/carbon filter
Chemical and associated product manufacturing	Medicinal, pharmaceutical or veterinary products	COD, As, Cd, Cr, Phenol	Low	Sand/peat/carbon filter
Chemical and associated product manufacturing	Batteries	Pb, pH	High	Sand/peat/carbonate filter
Chemical and associated product manufacturing	Fungicides, herbicides, pesticides, timber preservatives and related products	COD, pH, As, Cu, Cr, pesticides	High	Sand/peat/carbonate filter
Chemical and associated product manufacturing	Industrial gas	N, pH, TSS	Never Low	Sand filter
Animal feedstuffs	Stock food manufacture storage or handling	BOD, TSS	Medium	Swale/high plant surface area and soil organics
Transport and related activities	Bus depots	Cu, Zn, TSS, TPH, PAH	Low	Sand/peat/carbon filter
Transport and related activities	Commercial airports	Oil and grease, TSS, COD	Low	Settling, oil/water separator, sand/peat/carbon filter
Machinery or equipment manufacturing	Motor vehicles or parts	Oil and grease, Fe, Al, Zn	Low	Sand filter
Food or beverage manufacturing or handling	Other foodstuffs manufacturing	BOD, TSS, oil and grease, N	Low	Oil/water separator, high plant activity and surface area
Food or beverage manufacturing or handling	Flour mill or cereal foods	BOD, TSS, oil and grease, N	Low	Oil/water separator, high plant activity and surface area
Food or beverage manufacturing or handling	Bakery product manufacturing	BOD, TSS, oil and grease, N	Less than 1000 m ² - Low	Oil/water separator, high plant activity and surface area
			1000 m ² to 5000 m ² - Medium	
			Over 5000 m ² - high	

Industrial Activity	Description of Trade	Contaminants of Concern	Likelihood of Release	Treatment Processes
Chemical and associated product manufacturing	Cosmetics, toiletry, soap and other detergents	Zn, N	Never Low	oil/water separator, oxidation, sand/peat filter
Printers	Printing and publishing facilities	Solvent, heavy metal, Cr, Pb, metals, fuel, spent solvents	Medium	Oil/water separators, sand/peat filter
Spray painting facilities	Surface coating of materials using a spray atomising system	Pigment, resins, solvents, thinners, other plastics components	High	Use of a spray booth with filters Sand/peat filter
Truck wash facilities	Washing vehicles	TSS, oils and grease, COD	High	Sedimentation followed by oil/water separation followed by a sand/peat filter
Textile fibre and textile processing industries where dyeing and washing of fabric occurs	The entire process of manufacturing materials from raw materials	TSS, pH, oil and grease, COD, heavy metals	High	Sedimentation, oil/water separation, wetlands
Footwear manufacture	Manufacture of footwear	Chlorinated phenols, tribromophenol, chlorinated paraffins, dyes, adhesives, pH, chromium, plasticisers	Medium	Oil/water separators, wetlands
Stock saleyards	Commercial conduct of yards where cattle, sheep or other animals are sold	BOD, sediment, nutrients, metals	High	Wastewater lagoon, wetlands
Car wash and valet services	Washing and cleaning vehicles	TSS, oils and grease, COD	High	Sedimentation followed by oil/water separation followed by a sand/peat filter
Commercial laundries (excluding self-service laundrettes and laundromats)	Providing laundered clothing and other items to industrial or commercial users	Waste oil, recovered solvents, vehicle maintenance waste, lint, plastic bags	Medium	Oil/water separation, sand filter
Agricultural support industries	Other chemical products (e.g. plastic manufacturing)	Solvents, Plasticisers, Paint, Resins, Scrap plastic. Fuels Miscellaneous chemicals	Less than 1000 m ² - Low	Minimise exposure Sand/peat/carbon filter Oil/water separator
			1000 m ² to 5000 m ² - Medium	
			Over 5000 m ² - high	

NOTE:

* BTEX is an acronym standing for benzene, toluene, ethylbenzene, xylenes that are volatile organic compounds (VOCs) found in petroleum products. Carbon filters are effective at removing sediment and VOCs

Symbols: Ag Silver, Al Aluminium, As Arsenic, BOD Biochemical Oxygen Demand, Cd Cadmium, COD Chemical Oxygen Demand, Cr Chromium, Cu Copper, Fe Iron, GPs Gross Particulates, N Nitrogen, NH₃ Ammonia, Ni Nickel, NO₃ + NO₂ Nitrate and Nitrites, P Phosphorus, PAH Polycyclic Aromatic Hydrocarbon, Pb Lead, Sn Tin, TP Total Petroleum Hydrocarbon, TSS Total Suspended Solids, VOCs Volatile Organic Compounds, Zn Zinc.

There may be variations to each of the categories listed in Table 13-1.

Table 13-2 below provides a summary of the removal mechanisms for a range of contaminants.

Table 13-2: Summary of contaminant removal mechanisms

Mechanism	Contaminants affected	Removal promoted by
Physical sedimentation	Solids, BOD, pathogens, particulate COD, P, N, metals, synthetic organics	Low turbulence
Filtration	Same as sedimentation	Fine, dense herbaceous plants, constructed filters
Soil incorporation	All	Medium-fine texture
Chemical precipitation	Dissolved P, metals	High alkalinity
Adsorption	Dissolved P, metals, synthetic organics	High soil Al, Fe, high soil organics, neutral pH
Ion exchange	Dissolved metals	High soil cation exchange capacity
Oxidation	COD, petroleum hydrocarbons, synthetic organics	Aerobic conditions
Photolysis	Same as oxidation	High light
Volatilisation	Volatile petroleum hydrocarbons and synthetic organics	High temperature and air movement
Biological microbial decomposition	BOD, COD, petroleum hydrocarbons, synthetic organics	High plant surface area and soil organics
Plant uptake and metabolism	P, N, metals	High plant activity and surface area
Natural die-off	Pathogens	Plant excretions
Nitrification	NH ₃ -N	Dissolved oxygen > 2mg/l, low toxicants, temperature > 5-7°C, neutral pH
Denitrification	NO ₃ +NO ₂ -N	Anaerobic, low toxicants, temperature > 15°C

NOTE:

Symbols: Al Aluminium, BOD Biochemical Oxygen Demand, COD Chemical Oxygen Demand, Fe Iron, N Nitrogen, NH₃-N Ammonia, NO₃ + NO₂-N Nitrate and Nitrites, P Phosphorus.

13.4 Stormwater management devices

Stormwater discharges from industrial sites must be managed in accordance with the design criteria provided in Section 7.4 and must be supported by Pollution Control Plans¹⁶⁰ and / or Operations and Maintenance Plans where applicable.

A brief discussion is provided below about the stormwater management devices and their appropriateness in providing water quality and quantity management for industrial sites. The design of these devices is detailed in Section 8.

Most of these devices are appropriate for managing stormwater runoff from industrial sites. However, the use of infiltration devices as a water quality treatment device is not encouraged on industrial sites. The ground is itself a receiving system and contaminants may migrate to groundwater and be discharged into another receiving system (stream, estuary, harbour, open coast, lake). In all cases where stormwater runoff is anticipated, treatment should be provided prior to discharge to prevent migration of contaminants to the receiving environment.

¹⁶⁰ Pollution Control Plans are generally a requirement of bylaws pertaining to Stormwater and Tradewaste.

The following discussion relates to a number of devices in this guideline. A practice not included is green roofs as they are not normally used for site treatment of industrial sites.

13.4.1 Stormwater management ponds

Water quantity function

Stormwater management ponds are effective at controlled release of stormwater flows related to extended detention for stream erosion protection, intermediate storm control and can also be designed to provide a controlled release for extreme storm events.



Water quality function processes

The primary contaminant removal mechanism of all pond systems is settling or sedimentation. They can be effective at removal of suspended solids (50% – 90%) and have lesser effectiveness for removal of metals, whose removal is primarily through attachment to sediments that may be captured in ponds.

One pond component that should be considered is the use of the reverse slope outlet for the capture of hydrocarbons that would otherwise go through surface withdrawal outlets. Water has a specific gravity of 1 and Oil has a specific gravity of 0.9, diesel has a specific gravity of 0.85, kerosene of 0.79 and gasoline has a specific gravity of 0.75. These values show that hydrocarbons will rise to the surface of the stormwater where they will be trapped and allow volatilization to occur.

For information about specific industries' contaminants of concern, refer to Table 13-1. If a particular industry lists oil and grease as a contaminant of concern they have to provide treatment for hydrocarbons. Treatment strategies should be based on site processes as to what contaminants will be of concern. If they are using a pond or wetland they would have to use a submerged outlet pipe to enhance hydrocarbon removal.

A design consideration when hydrocarbons are a stormwater concern is the potential for emulsification to occur when turbulence is not reduced when traveling through the pond device. The turbulence of stormwater flows can cause the mixing of oil and water and a reduced capture of the hydrocarbons prior to downstream release.

It is essential in designing for hydrocarbon capture that the horizontal flow of stormwater through the pond should be less than 15 times the rise velocity. The rise velocity is the following:

$$V_r = \frac{gd^2(1-s)}{18\nu}$$

Where:

V_r = rise velocity (m/s)

g = acceleration due to gravity (9.8 m/s²)

d = diameter of the oil droplet (m) = 0.00006

s = specific gravity for the oil droplet (as stated above)

ν = kinematic viscosity of water (m²/s) = 0.00000138

By calculating the rise velocity, the maximum horizontal velocity through the pond can be calculated to determine if hydrocarbon capture is maximised. The slower the horizontal velocity the greater the percentage of hydrocarbons that are captured.

13.4.2 Constructed wetlands

Water quantity function

Wetlands, identically to ponds, are effective at controlled release of stormwater flows related to extended detention for stream erosion protection and intermediate storm control. Wetlands can also be designed to provide a controlled release for extreme storm events.

Water quality function processes

Wetlands can provide the same sedimentation benefits of deeper ponds but they also provide additional treatment through mechanisms that do not exist in deeper ponds. Those mechanisms include the following:

- Biological degradation, sedimentation, microbial uptake of organic material.
- Adsorption, volatilisation, photosynthesis, and biotic/abiotic degradation of organic contaminants.
- Sedimentation, filtration of suspended solids.
- Sedimentation, nitrification/denitrification, microbial uptake, plant uptake, volatilisation for nitrogen removal.
- Sedimentation, filtration, adsorption, plant and microbial uptake for phosphorus removal.
- Natural die-off, sedimentation, filtration, predation, UV degradation, adsorption for pathogens, and
- Sedimentation, adsorption, plant uptake for heavy metal reduction.



The accumulation of organic matter from dead plant material also promotes contaminant removal. High-density wetland vegetation is likely to achieve higher treatment efficiency than lower density because the larger surface contact area supports more microorganisms that mediate contaminant removal processes.

13.4.3 Sand and sand/peat filters

Water quantity function

Sand filters are water quality treatment devices and generally provide little control of stormwater quantity. They can be adapted for larger flow control by increasing live storage.

Basic water quality function processes

Sand filters reduce contaminants by a variety of chemical, physical and biological processes. In some cases, the contaminants are transformed (decomposition, decay) and in other cases they simply accumulate in the filter media. The removal processes include:

- Sedimentation
- Adsorption
- Volatilisation
- Filtration
- Biological processes

While sand is a fairly sterile media, other processes do occur related to the capture of contaminants such as oil and grease, which form an organic biofilm that facilitates removal of metals. This is more of a by-product of system performance rather than a designed function.



Sand/peat filters or sand/peat/carbon filters operate similarly to sand filters although sand/peat filters, by addition of peat, use the peat due to its organic content to remove soluble metals through adhesion of the metals to the organic particles. The use of carbon is of value for removal of organics as chemical absorption takes place as carbon is activated by a positive charge and attracts negatively charged contaminants. Carbon is not effective at removal on dissolved inorganic compounds. In terms of industrial sites, wherever dissolved metals are contaminants of concern, peat will probably be used in a 50:50 blend to facilitate removal of the metals. When activated carbon is used as a media, the proportion should be 45:45:10 with 10% being activated carbon.

13.4.4 Bioretention

Water quantity function

Bioretention devices are primarily water quality treatment devices and provide little control of stormwater quantity.

Water quality function processes

Bioretention devices include the same contaminant removal mechanisms that sand filters do but also include additional processes that can further improve water quality performance. Topsoil can be very effective in removing heavy metals through organic complexing. Soil bacteria can metabolise oil, grease, and petrol and plants uptake, transpire, accumulate and detoxify metals and many other toxic compounds.



Bioretention devices have lower permeability rates than do sand filters due to the blending of topsoil into the sand. As such they would require a greater surface area than do sand filters so their selection in lieu of sand filters should be based on the need to reduce soluble metals as a primary consideration. If they are not present or hydrocarbons are the primary contaminant of concern then sand filters could be used.

13.4.5 Infiltration devices

Water quantity function

Infiltration devices can provide peak flow control when permeability rates are high enough to allow for rapid infiltration of runoff. For industrial sites infiltration devices should only be used when runoff has been treated prior to entry into the infiltration device.

Water quality function processes

Infiltration devices direct stormwater runoff away from surface runoff paths and into the underlying soil. This is very different from using devices that have underdrains, which then would be considered as subsurface detention devices. Where surface runoff systems (ponds, wetland, filters, etc.) direct water to streams or estuaries, infiltration devices direct the runoff to groundwater. They comprise a suite of devices including trenches, dry wells and permeable pavement.

Infiltration of runoff from an industrial site after treatment using a sand filter



The use of infiltration devices on industrial sites should be restricted or at least considered with caution. Infiltration devices are sensitive to clogging and run the risk of transporting contaminants to groundwater.

From a water quality perspective the following specific processes alter the quality of infiltrating water during ponding and subsurface travel:

- Filtration
- Adsorption
- Biodegradation
- Growth of micro-organisms
- Chemical oxidation and reduction
- Chemical precipitation and dilution
- Volatilisation
- Photochemical reactions

Soils vary in their ability to filter and adsorb and a greater discussion of their processes is probably beyond what is needed here.

13.4.6 Swales and filter strips

Water quantity function

Swales and filter strips are water quality devices and have negligible capability for storage of stormwater flows. They are water quality treatment devices although with some modification through subsurface storage and discharge they could provide storage to achieve retention of the initial abstraction or possibly extended detention.

Water quality function processes

Contaminant removal depends on the residence time of water through the swale or filter strip and the depth of water relative to the height of vegetation. Good contact with vegetation and soil is required to promote the operation of the various mechanisms that capture and transform contaminants, so spreading flow in minimal depth over a wide area is best.

Swale providing pre-treatment of industrial runoff prior to runoff entering a sand filter



The passage of stormwater through vegetated swales and filter strips utilises a number of physical, chemical and biological processes to remove stormwater contaminants. Those factors include the following:

- Reduction of flow speed by vegetation to improve settlement
- Filtration by dense vegetation
- The rough nature of the soil/vegetation interface which improves retention of settled material and reduces resuspension
- Some infiltration of runoff depending on soil conditions
- Contact between stormwater contaminant and the abundant organic matter in swales which can result in adsorption
- Existence of micro-organisms which degrade organic contaminants

- Uptake of contaminants by plants

Although Section 8 recommends a flow residence time of 9 minutes, significant water quality benefits can be gained by smaller residence times. Metals reductions can be significant even with shorter residence times although TSS reductions will be somewhat less.

13.4.7 Oil and water separators

Water quantity function

Oil and water separators are water quality treatment devices only.

Basic water quality function processes

Oil and water separators are applicable to treat stormwater runoff from areas where hydrocarbon products are handled or where small spills routinely fall on paved surfaces exposed to rain. They are not usually applicable for general urban runoff, because by the time the oil reaches the device it has emulsified or coated sediment in the runoff and is too difficult to separate.

Oil and water separators have significant benefits for spill containment. Spills enter the separator and mix with the water. Then the oil in the spill will rise to the surface. All separators should hold the 2,500 litres of oil that is the industry standard. Grease and oil will be present as oil droplets of different sizes or as a surface slick.



Oil products have a specific gravity that is lighter than water. The actual specific gravity depends on water temperature and the density of the oil. Oil and water separators use the fact that oil entering the separator will rise to the surface of the water and be prevented from exiting by the presence of baffles. The use of oil specific gravity of 0.9 is considered appropriate for general use as diesel has a specific gravity of 0.85, kerosene of 0.79 and gasoline has a specific gravity of 0.77.

13.4.8 Oxidation

While not discussed as a device in these guidelines, oxidation is mentioned as a treatment practice for some industrial contaminants.

Oxidation is the interaction between oxygen molecules and all of the various substances that they interact with. It involves the loss of at least one electron when two or more substances

interact. From an industrial contaminant perspective, oxidation is the assurance of an aerobic environment for promotion of contaminant reduction. This can be undertaken mechanically or by ensuring that anaerobic conditions do not develop.

Where oxidation is listed as a treatment process, wetlands should not be used. Wetlands may become anaerobic over the summer months, which will reduce potential to deal with certain contaminant conditions.

13.5 Conclusion

Implementation of source control for all industrial sites is a responsibility that all industries in the Region must accept. Bylaws, Codes of Practice and Resource Consents that have clauses relating to management of site contaminants must be recognized and given effect to in the design of stormwater management systems and Pollution Control Plans.

Source control is good business as chemicals used in the industrial operation can cause contamination if they are discharged off site. Reducing contaminant discharge results in less wastage of chemicals, which has benefits in terms of reduced purchase of chemicals. Having leaky pipes costs money, as chemicals are lost.



Source control can be as simple as recycling materials, such as oil, solvents, aluminium, steel and other metals, glass, cardboard and newspaper and office paper.

Industries listed in Table 13-1 have a high likelihood of contaminant release and should have an aggressive source control programme to reduce contaminant discharge. A number of these high potential contaminant release industries may have to implement stormwater treatment to provide adequate site control, but source control is absolutely essential if aquatic receiving systems are to remain healthy.

While source control should always be provided, treatment is also necessary as not all contaminants can generally be eliminated through source control. Treatment devices should be carefully selected to ensure that contaminants of concern are targeted for removal by a device (or devices) whose functioning facilitates their removal.

As discussed in Section 13.2.6, any stormwater diversion and discharge consent application for an industrial activity must provide information related to potential deposition of contaminants from dry deposition on roof areas. Based on this information, council will determine the need for water quality treatment of roof runoff.

It must also be recognised that water quantity must also be addressed on new sites or where significant site modification is intended. Refer to earlier sections of this guideline for information about managing water quantity effects. This guideline provides guidance for addressing stormwater management on industrial sites. There are other elements related to specific industry sites that are not discussed in this section. It is important that industrial site management become familiar with all aspects of their industrial activity through industry and internet searches to have regard to all aspects of site activity.

14 Rural residential development

Much of the background information in this section has come from *'The Countryside Living Toolbox'*¹⁶¹ a document that was prepared for several local councils in the Auckland Region.

14.1 Introduction

There is a recurring theme to urban intensification into rural areas. Initially, development occurs on large lots that have individual water supply and wastewater treatment. As further intensification occurs, these rural lots are subdivided into smaller lots and the smaller lots increase pressure on local councils to provide water supply and wastewater treatment. Once those infrastructures are in place, further intensification can be expected.

This guidance addresses stormwater management concerns for the initial rural residential development, be it an individual home or a small rural subdivision. It is specifically targeted for rural residential development that is most often a permitted activity.

The Regional Plan provides for permitted activities subject to the following conditions:

- a) There shall be no adverse effect on water quality of the receiving water body.
- b) Any adverse erosion effects occurring as a result of the discharge to be remedied as soon as practicable.
- c) There shall be no adverse effects from increased water levels downstream of the discharge point.
- d) The Waikato Regional Council shall be notified in writing of the discharge, its volume, contaminant concentrations and the water quality of the receiving water body 10 working days prior to the discharge commencing.

This section provides guidance on how rural residential development can comply with the permitted activity requirements.

14.2 Key objectives

The primary objective of the rural residential guidance is to outline and demonstrate the minimum acceptable approach for stormwater management in rural residential areas in the Waikato Region. It provides a variety of approaches ranging from using natural vegetation to mitigate effects, to the use of structural stormwater management devices.

The goals of the guidance are:

1. To minimise changes to the hydrological regime in order to protect the physical structure of streams and also to reduce potential downstream flooding; and
2. To reduce sediment discharges resulting from increased stream channel erosion and small scale rural development.

14.3 General principles

Stormwater management needs to be considered during the earliest stages of site design. The way a site or subdivision is laid out can directly affect the volume and quality of stormwater which is discharged from the site. There are a number of general principles which apply to site design and preventing stormwater effects¹⁶².

Changes to the hydrological regime should be minimized.

¹⁶¹ Rodney District Council and Waitakere City Council 2009

¹⁶² URS, 2005

- Piped stormwater discharges should be set back from streams and incorporate erosion protection to prevent localized scour and erosion.
- Dispersed discharges are preferred over concentrated flow discharges.
- Site disturbance should be minimized and natural features/ vegetation protected.
- Sediment control should be utilized during the construction phase.
- Impervious areas should be limited to the greatest extent possible.
- Appropriate stormwater management devices should be used to attenuate flows and provide water quality treatment.

Effective stormwater management includes the implementation of both structural controls (i.e. stormwater devices) and non-structural controls (such as site design).

14.4 Source, flowpaths and receiving environments

Recognising that stormwater issues may not be well understood by an individual rural residential property owner or developer, it is important to understand the process of runoff movement through a property to a receiving environment. This process depends on three levels of consideration:

- Source,
- Pathway, and
- Receiving environment.

14.4.1 Source

In this context, source essentially means the impervious areas created by development itself, specifically the roofs, driveways, local roads and parking areas. For rural residential development, roofs will generally go to water tanks, driveways should disperse downslope and local roading will have swales or filter strips. Swales and filter strips function as pathways for the stormwater to travel from the source to the receiving environment.

The main issues related to source are the level of imperviousness and the potential contaminant load coming from those surfaces. Reducing the source therefore reduces the effects of impervious surfaces. One of the aims of this section is to recommend measures which will reduce and disconnect impervious areas.

14.4.2 Pathway

The pathway is the route taken by stormwater runoff from the source to the receiving environment. The pathway can include:

- Overland dispersed flow across vegetation,
- Flow via a vegetated swale,
- Surface flow in a ditch, or
- Flow in a concrete channel or reticulation system

The pathway is important from two different contexts:

- A means of delivery of stormwater runoff to a receiving environment, and
- The stability and design of the pathway itself.

As a means of delivery, the pathway can, depending on its composition, convey water very quickly to a receiving system or, by following natural drainage paths, deliver the stormwater to the receiving system at a more natural rate, resulting in fewer adverse impacts. The following two tables provide information on stormwater conveyance. The first table, Table 14-1 provides

information on Mannings roughness coefficients, which in turn relate to flow velocities. The higher the Mannings coefficient, the lower the velocity.

Table 14-1: Recommended design values of Manning’s roughness coefficients¹⁶³

Channel condition	Mannings <i>n</i> range
Unlined open channels	
Earth, uniform section	
Clean, after weathering	0.018-0.02
In graveled soil, uniform section, clean	0.022-0.025
Earth, fairly uniform section	
No vegetation	0.022-0.025
Sides clean, cobble bottom	0.030-0.040
Rock	
Smooth and uniform	0.035-0.040
Jagged and irregular	0.040-0.045
Channels not maintained, weeds and brush uncut	
Dense weeds, high as flow depth	0.08-0.12
Clean bottom, brush on sides	0.05-0.08
Roadside channels and swales with maintained vegetation	
Depth of flow up to 210 mm	
Good stand, any grass	
Length about 300 mm	0.09-0.18
Length about 600 mm	0.15-0.30
Depth of flow 210mm-450mm	
Good stand, any grass	
Length about 300 mm	0.07-0.12
Length about 600 mm	0.10-0.20
Natural stream channels	
Minor streams	
Fairly regular section	
Some grass and weeds, little or no brush	0.030-0.035
Some weed, heavy brush on banks	0.05-0.07
Irregular section, with pools, slight channel meander; increase two above values by	0.01-0.02
Mountain streams, no vegetation in channel, banks usually steep	
Bottom of gravel, cobbles and a few boulders	0.04-0.05
Bottom of cobbles, with large boulders	0.05-0.07

¹⁶³ McCuen, 1989

Table 14-2 relates the type of channel material with permissible velocities to ensure that channel erosion is kept to a minimum.

Table 14-2: Maximum permissible velocities for unlined channels¹⁶⁴

Material	Mean velocity (m/s)
Fine sand, colloidal	0.4
Sandy loam, noncolloidal	0.5
Silt loam, noncolloidal	0.6
Alluvial silts, noncolloidal	0.6
Ordinary firm loam	0.8
Volcanic ash	0.8
Stiff clay, very colloidal	1.1
Alluvial silts, colloidal	1.1
Shales and hardpans	1.8
Fine gravel	0.8
Graded loam to cobbles, noncolloidal	1.1
Graded silts to cobbles, colloidal	1.2
Coarse gravel, noncolloidal	1.2
Cobbles and shingles	1.5

The combination of the two tables helps to answer questions related to the following issues:

- Is the stormwater pathway adequate in terms of stability for stormwater drainage to enter it with minimal impact, and
- Would the pathway provide mitigation for stormwater runoff quantity and quality?

The answer to the first question can be resolved through consideration of the pathways for runoff from a specific development. The answer to the second one is slightly more complicated and requires some discussion.

As adverse effects of stormwater are cumulative, a key question relating to pathways will relate to the following:

- The erosional potential of the pathway, and
- The expected contaminant load

14.4.2.1 The erosion potential of the pathway

If the stormwater discharge goes to a high-energy receiving environment or natural features of the pathway provide stormwater treatment and water quality concerns are not an issue, the stability of the pathway will determine whether stormwater management would be recommended for a project. If the pathway is a stable system and can accommodate the additional flow of a new project then stormwater management for pathway protection is not required.

14.4.2.2 The expected contaminant load

A key element with respect to water quality treatment will depend on the pathway. If the pathway is a densely vegetated system that can provide water quality treatment, that treatment may substitute for downstream stormwater quality treatment on a given project. Drainage systems in rural areas that are not kerbed and rely on passage of stormwater through swales or filter strips will have water quality treatment benefits that may substitute for more formal treatment systems. Having organic matter and vegetation can provide significant water quality

¹⁶⁴ Auckland Regional Council, 2003

benefits and the potential value of using those systems should be incorporated into design and operation.

14.4.3 Receiving environment

Whether a particular receiving environment is at risk is determined by a consideration of the overall risk from the source-pathway-receptor combination. Types of receiving environments include:

- Streams
- Floodplains
- Wetlands
- Ground
- Karst areas
- Estuaries
- Harbours
- Open coasts
- Lakes
- Geothermal areas

Stormwater issues related to receiving environments are detailed in Table 4-3 provided earlier in this guideline.

In addition, a key issue relating to all receiving environments is the provision of outfall erosion protection in order to ensure scour at the point of discharge is minimised. Any item in the table that is identified with either a high or moderate priority must be addressed in design and implementation. Low priority items should be discussed with Waikato Regional Council to determine if that item needs consideration during design.

An example of the consideration of source, pathway and receiving environment is shown in Figure 14-1.

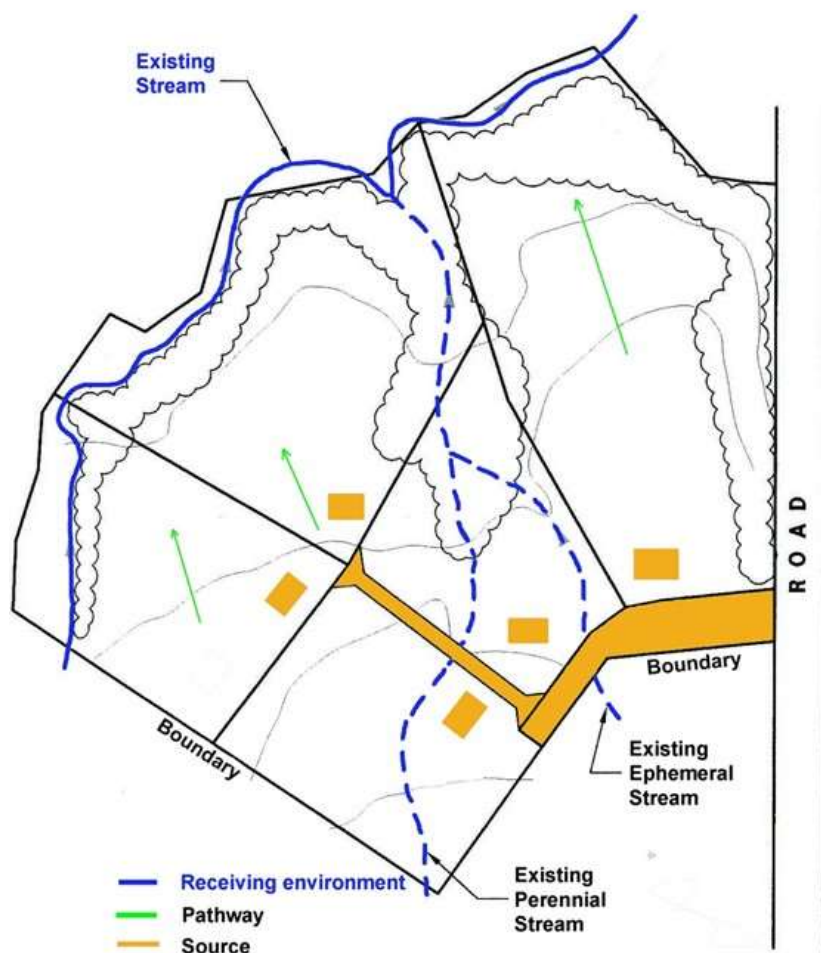

Figure 14-1: Example of a small rural residential development¹⁶⁵

¹⁶⁵ Adapted from Figure 5-3 in Countryside Living Methods (Version 3), 2005

Consideration of source, pathway and receiving environment will therefore assist in determining the stormwater management design objectives.

14.5 Hydrology

Hydrologic analysis is broken into two parts:

- An individual residence constructed in a rural area, or
- A rural residential subdivision.

14.5.1 An individual residence

If an individual residence is constructed in a rural zone, stormwater management requirements can be met through a series of devices that eliminate the need for a more detailed analysis. Those devices include:

- Capture of roof runoff in a water tank that is used for domestic water supply. The overflow from the tank shall be discharged into an infiltration soakage pit (refer to Section 8.5.5) or a bioretention device (Section 8.5.4).
- Runoff from driveways, access roads shall be accounted for either through soakage (Section 8.5.5), bioretention (Section 8.5.4) or bush revegetation according to Section 8.5.9.
- If there is significant earthworking proposed to facilitate construction, those disturbed areas of the site should be rehabilitated according to Section 8.5.11.

14.5.2 Rural residential subdivision

Hydrologic analysis shall be undertaken according to the Waikato Stormwater Runoff Modelling Guideline. The same requirements as required in Section 7.4 shall be designed for on these developments. This includes retention of the initial abstraction of water before runoff begins.

14.5.3 Device capability to detain flows

There are two potential detention requirements for rural residential subdivisions:

- Detention for peak flow control, and
- Extended detention for downstream erosion protection.

14.5.3.1 Detention for peak flow control

Rural development normally does not involve mass grading of an entire development site. This ensures that the runoff from pervious areas is essentially unchanged from the predevelopment condition. As such, stormwater management devices should only be designed and constructed for those specific areas that need management.

Certain devices can provide control of the differences in the 2 and 10-year ARI events by providing storage within the device. Devices that can provide volume control of the difference in peak discharges for the 2 and 10-year ARI events are the following:

- Swales with underdrains and check dams
- Bioretention
- Infiltration trenches
- Water tanks
- Revegetation, and
- Green roofs.

The discussion on extended detention control by providing the water quality volume (or 1.2 times the water quality volume if there is downstream channel instability) for design also

provides for control of the volume increases for the 2 and 10-year ARI events if designed correctly. The combination of live storage on the device and void ratios in the devices themselves provides for separation of the 2 and 10-year ARI volume increases from the storm hydrograph.

If this approach is taken, there is no need to design and construct separate peak control devices for developments. A key point is that the device must manage only those areas that require management such as driveways and impervious surfaces. If runoff from additional land area not needing management drains to the device, the volumes needed for storage increase significantly and control of the 2 and 10-year ARI events becomes more difficult. If extraneous drainage cannot be kept out of the stormwater device, attenuation of the peak flows for the 2 and 10-year ARI events may be necessary and conventional storage devices such as ponds or wetlands (Section 8.5.6 and Section 8.5.7) must be used to provide detention storage.

When there exists documented downstream flooding of habitable structures in a catchment, there can be no increased risk as a result of rural land development. The issue of where in a catchment storage of runoff is beneficial to prevent increased potential flooding and where storage may increase flood potential due to flood peaks coinciding (from the site and the catchment) is discussed in Section 7.1.3. Section 7.1 also provides design criteria for storage to ensure that potential flood increases are avoided.

Where there is documented downstream flooding of habitable structures, the best approach (in the absence of a catchment management plan) is to ensure that the post-development peak discharge for the 100-year ARI event does not exceed 80% of the pre-development peak discharge for the 100-year ARI event as discussed in Section 7.1.1. This will minimise the potential increase in downstream flooding.

14.5.3.2 Extended detention for downstream erosion protection

Critical issues in rural development design, from a stormwater management perspective, are related to increases in stormwater runoff adversely impacting on receiving system physical structure. As such, the extended detention of flows to minimise downstream channel erosion is an important issue. Minimising increases in the total volume of stormwater being discharged will mitigate increases and may through careful design and use of a treatment train approach significantly reduce or eliminate stormwater runoff volume increases to reduce or eliminate the extended detention requirement.

A key difference in calculating stormwater runoff from rural properties versus urban ones is that significant site regrading is generally minimised in rural areas and there is no change to pervious area predevelopment runoff factors for most of the site. If impervious surface volume is reduced or mitigated for from a flow perspective, receiving system stability can be maintained.

Implementation of the following devices can significantly reduce the need for a formal extended detention on a site design basis.

- Bioretention and infiltration – increasing the storage volumes beyond the water quality storm can allow them to function for extended detention control.
- Bush planting – Using the bush revegetation can provide a reduction in total runoff volume.
- Rain tanks – domestic consumption and extended detention release can fulfil the requirement.
- Green roofs - provide for storage and evapotranspiration to reduce runoff volumes.
- Swales and filter strips - Swales and filter strips do not provide extended detention benefits using a conventional design. The swale design section does discuss the use of underdrains in shallow slope areas and having a modified soil profile with an underdrain can provide extended detention benefits. Filter strips do not generally provide extended detention benefits, as modification of soils on shallow slope areas is not a recommended approach.

- Wetland swales - In a similar manner as swales and filter strips, wetland swales do not provide extended detention. Having a series of check dams can provide for extended detention if designed specifically to provide that function.
- Ponds and wetlands - Ponds and wetlands can easily be modified to provide for extended detention. There may be situations where an existing pond can be modified to provide for additional storage either by lowering the normal pool level or modifying the embankment or outlet structure.

14.6 Stormwater management device design

The stormwater management devices have design criteria specified in Section 8.5. Of particular applicability on rural residential sites the following are emphasised:

- Swales (Section 8.5.1)
- Filter strips (Section 8.5.2)
- Bioretention (Section 8.5.4)
- Infiltration trenches and soakage pits (Section 8.5.5)
- Wetland swales (Section 8.5.7)
- Water tanks (Section 8.5.10)
- Bush revegetation (Section 8.5.9), and
- Green roofs (Section 8.5.8).

15 Waikato Regional Council administered drainage areas

Much of the background information included in this section is from Waikato Regional Council's report '*Managing land use change and Council's administered drainage areas*'¹⁶⁶.

15.1 Introduction

There are significant areas in the Waikato Region that are very flat and getting water off the land and into a positive outfall are difficult. As a result rural drainage channels have been constructed to provide land drainage for agricultural purposes, to lower localised water tables and to reduce flooding potential. Many of these drainage systems have been formalised to constitute land drainage areas.

Waikato Regional Council is responsible for administering many of these drainage systems. At the present time it is responsible for managing and maintaining drainage networks within 92 separate areas in the region. Four drainage advisor subcommittees have been established to oversee the management of the drainage areas; Aka Aka/Otaua, Franklin Waikato, Waikato Central and Thames Valley. Figure 15-1 shows where these drainage areas are within the region.

In addition, six territorial authorities also manage drainage systems that are not managed by Waikato Regional Council. The territorial administered drainage areas are shown on Figure 15-1.

These systems have been established to serve rural land use with a primary emphasis on ensuring land productivity and accessibility.



¹⁶⁶ Wood M, 2014

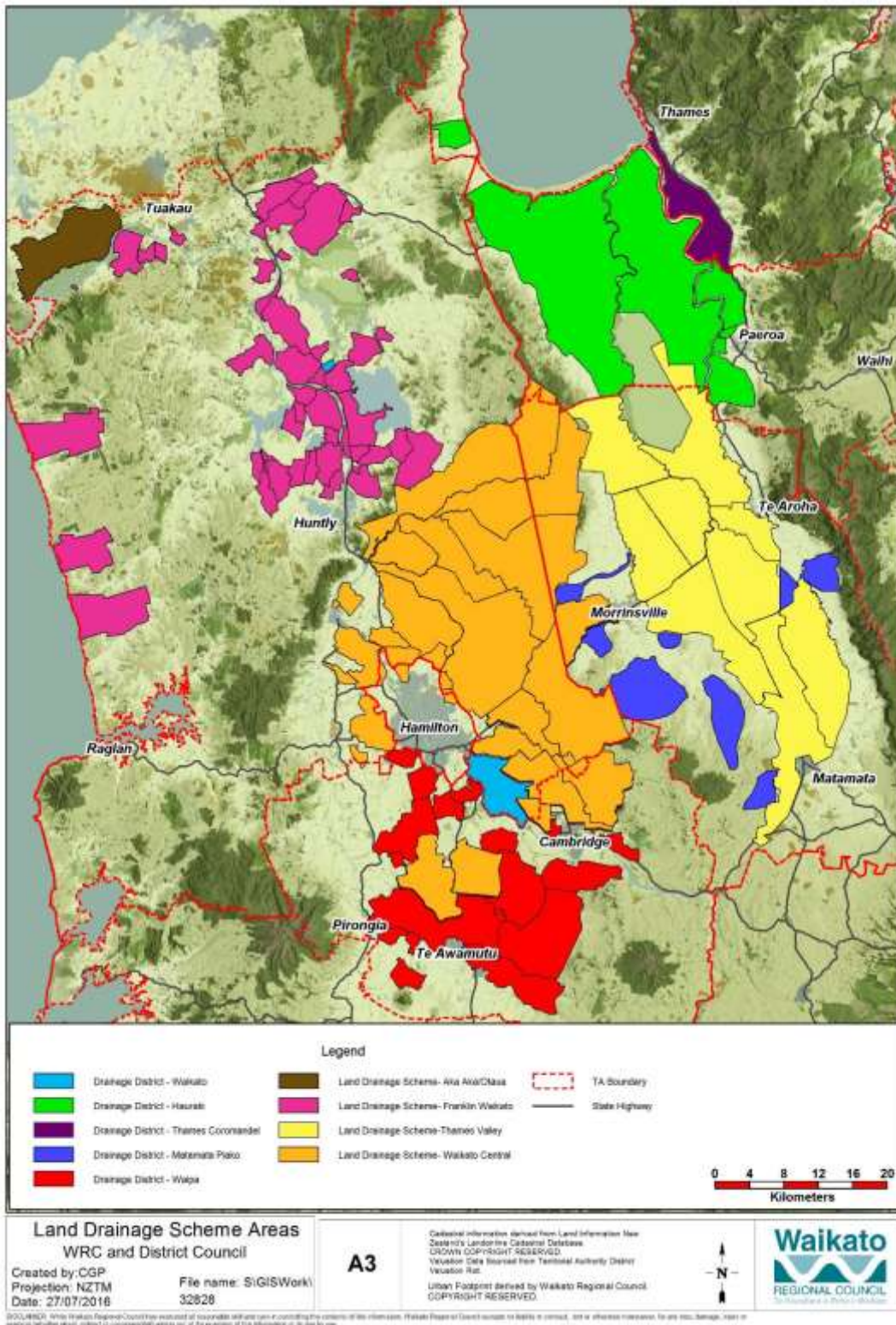

Figure 15-1: Waikato Regional Council and territorial authority drainage areas

15.2 Drainage standards

Due to the nature of the various catchments, objectives can sometimes be met with different design standards. As a result designs in individual drainage systems need to be undertaken with consideration of the standards specific to the specific catchment.

In general though, the design approach is based on surface water flow only and the intent is to remove ponding from a storm with a 10-year annual exceedance probability (AEP) within three days. The reasoning behind the three day time period is to prevent significant pasture vegetation damage by standing water.

Due to different catchment and drainage characteristics of each drainage area, the runoff design standard for each drainage area varies. The following runoff standards have been adopted for each drainage area (runoff to be cleared within 24 hours):

Table 15-1: Drainage runoff design standard

Drainage area	Drainage standard (runoff to be cleared in 24 hours)
Thames Valley	38 mm
Franklin Waikato	25 mm
Waikato Central	
- Fencourt, Hautapu, Rotomanuka, Ohaup / Ngaroto	25 mm
- All others	38 mm
Aka Aka / Okaua	10 mm

An example of how these runoff standards are used is the 38 mm of runoff that is used in a number of drainage areas that has to clear the catchment within 24 hours. The 38 mm of runoff standard has been adopted for larger catchments/drainage areas and does assume/allow for some deterioration in the drain capacity between cleans, so that capacity would drop to approximately 20-25 mm/day before the system was cleaned and brought back to the 38 mm standard. It is a uniform criterion based on 20 mm of runoff per day over three days allowing for 60 mm total runoff from a 10-year rainfall event. The 20 mm standard is the minimum standard that must be maintained. Around the region a 10-year ARI 24-hour rainfall event is approximately 120 mm. Therefore the 20 mm/day runoff standard will allow for 60 mm of runoff total over three days, which is approximately 50% of the rainfall depth, which is a fair representation of total runoff from a 10-year ARI rainfall from rural pastoral areas.

15.3 Problem identification

Council’s administered drainage areas are generally necessary to ensure flat areas with limited drainage are drained to enable farming to be undertaken. These areas are rural and have a low level of service provided, they are informal drainage networks that have evolved over time to primarily manage groundwater levels, and convey flood flows to ensure ponding from a 10-year ARI event drains away within 3 days.

These land drainage areas were not established or designed to cater for urban stormwater runoff. A major issue associated with the changing nature of land use in these drainage areas is the likely change in expectation on how the drainage systems should perform. Those with a small residential lifestyle block will not want to accept a portion of the property being flooded for three days. Maintenance property access to undertake regular inspections and perform needed maintenance could also be an issue with land being divided up into smaller sections with more land owners to deal with.



Ideally these areas would remain rural, however land use intensification is occurring in the vicinity of some of these drainage areas, particularly around the fringes of Hamilton. The urban growth areas need outfalls and drainage area networks are being looked at to provide this. The drainage networks are not designed to take urban flows and the expansion of urban areas into these drainage systems can cause complications.

Conventional stormwater management approaches are generally used by consultants but that approach doesn't work well in these conditions, as attenuation leads to extended duration of peak flow, which can exacerbate erosion and scour issues in low capacity drains, and can also exacerbate ponding duration on adjacent land.

15.4 Urban development issues

There are several issues that need to be discussed regarding council administered drainage areas, as follows:

1. Their design is not based on peak flow but rather on getting a specific volume of water to drain the system within three days. Volumes of water are more important than peak rates of discharge.
2. The design approach has been based on an evolutionary approach to drainage rather than on specific criteria.
3. The drainage areas are very flat.
4. High velocities are not generally a problem due to the flat grades. Getting water out of the drainage systems due to lack of grade is the primary concern.
5. While lowering of local water tables is a goal, it is not a conveyance consideration.
6. Channel erosion is generally not an issue with existing rural runoff, but could be with increased flows. Areas with sandy soils need special consideration if the runoff and flow characteristics are likely to change.
7. The runoff standards do not account for climate change while intended urban development must consider that issue. This means there must be greater storage from new urban land uses than from rural land and is an issue that must be addressed.
8. There is some overlap with the council's stormwater management approach but criteria for council administered drainage areas will vary from region wide criteria due to being primarily a volume-based approach.

15.5 Land use change and drainage areas

15.5.1 Introduction

If you are undertaking a development that interacts with a Waikato Regional Council administered drainage area, refer to Waikato Regional Council’s document “*Managing land use change and Council’s administered drainage areas*” for further information on what to consider.

15.5.2 Site specific criteria

Criteria for urban development that proposes to drain to a Waikato Regional Council administered drainage area is as follows:

- Total volume of runoff from the post-development 10-year ARI rainfall must not exceed the pre-development runoff volume.
- The runoff depth that is released for the 10-year ARI event shall have an extended detention time of 72 hours so as not to overload the receiving drainage channel.
- Other criteria related to water quality treatment shall still be required.

The requirement for the runoff volume to not exceed the pre-development runoff volume for the 10-year ARI rainfall event is stringent. As a result, meeting this requirement negates the need to provide peak flow or erosion control as normally required in Section 7.4. Having the runoff volume not exceeding the pre-development runoff volume in conjunction with the 72-hour detention will meet those objectives.

If this criterion cannot be met then an assessment of effects will be required to demonstrate that no adverse effects are expected. The following outlines the information requirements.

15.5.3 Information requirements

The level of potential effects on a land drainage area depends on the scale of the proposed development, hence the level of assessment that is required can vary.

The following categories and associated information requirements have been developed to help provide clarity about what information is required for different levels of development. Note that the categories outlined below do not relate to any planning documents and have been developed for the purposes of this guidance only to help inform the assessment process.

If you are proposing to undertake a development that interacts with a Waikato Regional Council administered land drainage area, you will need to consider the following information requirements.

Table 15-2: Information requirements

Category	Activity	Information requirements	Comment
Small scale development	2 – 10 additional lots	As above. Also requires a drainage plan and additional information in accordance with Section 16.5.4 below.	Potential effects range from generally minor to potentially significant
Larger scale development	> 10 additional lots and/or Triggers non-compliance with Rule 3.5.11.4 Permitted Activity Rule – Discharge of Stormwater to Water ¹	As above but also requires an Assessment of Effects in accordance with Section 16.5.5 below.	Potential effects generally range from more than minor to potentially significant

NOTE:

- 1 Refer to the Waikato Regional Plan and to Waikato Regional Council’s Resource Use Group for queries relating to the rules.

15.5.4 Information requirements for small scale subdivision

This process outlines the key details required to be submitted to Waikato Regional Council when seeking drainage comments to undertake small scale subdivision that drains to, or is located within, a Waikato Regional Council managed drainage area.

1. The minimum details required are:
2. Name and address of the Surveyor.
3. Name and address of the Landowner/Developer.
4. Email addresses and phone numbers of the above.
5. Address and legal description of the land being subdivided.
6. Rates/Roll assessment number if available.
7. Name of the Waikato Regional Council drainage area that the subdivision lies in.
8. Layout plan of the proposal showing:
 - a) Titles of the new lots.
 - b) Nearest Waikato Regional Council managed drain.
 - c) Proposed drainage route linking the subdivision to the Council drain.
 - d) Ground levels in proposed new titles including the lowest ground levels.
 - e) Existing drain invert levels. This needs to extend at least 200m downstream of the proposed connection point to the Council drain.
 - f) A long section of the proposed drain inverts.
 - g) The proposed size of the new or upgraded drain linking to the Council drain.
 - h) The proposed size of any culverts in the proposed new or upgraded link drain.
 - i) The size of the nearest existing culvert in the Council drain, downstream of the proposed connection point.

If there is / or will be a Waikato Regional Council drain within the lot, and the lot is under 5 hectare, then Waikato Regional Council require an easement in favour of Waikato Regional Council.

To ensure ongoing access for maintenance purposes, within the area of subdivision the following is required:

- Access gates between lots are required along Waikato Regional Council drains.
- All hedging and trees are to be removed along Waikato Regional Council drains

15.5.5 Information requirements for larger scale development

For larger scale developments, those creating more than 10 additional lots, or those that trigger non-compliance with the Rule 3.5.11.4 Permitted Activity Rule – Discharge of Stormwater to Water, an assessment of effects is required to determine the potential effects of the activity and any proposed mitigation measures.

When preparing an assessment of effects for a proposed new discharge to a land drainage area, it is essential that the effects of the predicted increase in stormwater runoff are assessed on the drainage system to the point where it can be demonstrated that the predicted increase has no effect. This will generally be to the point where the drainage system exits into a natural system. Note that some drainage areas are extensive, such as the Komakorau, for this drainage area the assessment may need to extend to where the drainage system drains to the Mangawara River at Taupiri.

Currently developers are required to prepare stormwater management plans or catchment management plans for proposed developments as part of their resource consent/catchment

planning requirements. However the scope of these assessments generally end close to the point of discharge from the site. It is essential that if the proposed development is interacting with a land drainage area, that the assessment extends to the appropriate termination point.

The assessment would need to:

- Demonstrate that the drainage system could still meet the relevant design standard taking into account the increase in stormwater peak flows, velocities and volumes, including the tributaries of the drainage system.
- Consider potential effects of the proposal on groundwater levels, especially where the normal groundwater levels are naturally high.
- Consider ongoing operation and maintenance requirements.
- Include survey (topography and fall in drainage networks, especially in upper reaches) AND hydraulic modelling to inform the assessment.

If the assessment demonstrated that there was a predicted effect on the drainage system from the proposal, and there were no alternative discharge points available or options to mitigate the effects, the drainage system could be upgraded to accommodate the increase in flows and to ensure the drainage standard could be maintained. The system would need to be upgraded to the point where it was demonstrated that there was no effect. The upgrade option would need to consider potential effects on groundwater and would need to demonstrate that the groundwater level regime was not negatively impacted. Greater capacity can be provided by widening channels but not deepening them in these circumstances, as long as there is adequate fall in the system.

Where the receiving catchment contains peat land the assessment should also include consideration of how the system will change over time with peat settlement and what future proposals would need to be implemented to manage the increased stormwater input as peat settlement occurs.

If there is / or will be a Waikato Regional Council drain within the lot, and the lot is under 5 hectare, then Waikato Regional Council require an easement in favour of Waikato Regional Council.

To ensure ongoing access for maintenance purposes, within the area of subdivision the following is required:

- Access gates between lots are required along Waikato Regional Council drains.
- All hedging and trees are to be removed along Waikato Regional Council drains

15.5.6 Funding

The management of the drainage areas is currently funded by targeted drainage rates. There is no regional contribution to land drainage, with each respective area being self-funding through the rating structure. Each drainage area or subdivision has its own rating system and the rates collected within each system provide the income for the maintenance of that area only.

This funding system is based on rural properties being rated to maintain rural drainage systems for rural land use. The land drainage network is established to an agreed standard that is fair to all ratepayers, and where gravity drainage allows, clears water from the land to avoid damage to pasture.

There is a mechanism to classify urban land as an 'Urban' category and to rate at a higher level for this land, as is currently applied to properties in several areas in the region. The higher rating is uniform for the classification, hence does not necessarily reflect the true cost of the urban stormwater runoff input to the drainage network.

If a portion of an existing land drainage area becomes urban, then there will be a greater quantity of hard stand area, and hence higher volumes and peak flows and velocities of runoff will be generated within the catchment. This input into an existing rural drainage system could

cause adverse effects that could lead to an altered management and maintenance approach being required which is likely to be more costly. Based on the current funding system, the downstream rural land owners would be paying for the increased maintenance costs as a result of the upstream urban land use.

Ideally if a new urban area was to drain to a drainage area, a funding arrangement would be established to ensure all those in the contributing catchment were contributing funds to cover the costs of managing the drainage area at an appropriate rate.

Examples where funding arrangements are in place to address urban drainage discharging input rural drainage areas include Manor Park, Waitakauru and Matamata Urban.

15.5.7 Land ownership

While Waikato Regional Council has responsibility for a drainage network within drainage areas, most (if not all) of the drains are located on private land. Hence any modifications to the existing drainage systems to facilitate extra or increased flows would have to be arranged or funded by the developer. Consideration for gaining access and undertaking of works on any drains on private land would have to been taken into consideration by the developer.

15.6 Conclusion

Urban development in council administered drainage areas cannot be taken lightly. These drainage systems are operating at peak capacity and any increase in the volume of runoff will either increase the risk of flooding, the areal extent of the flooding and/or increase the duration of flooding. Development in these drainage systems must take all possible steps to protect other property owners from adverse impacts of the urban land use.

Increased widespread urban growth into these drainage systems will need to be considered carefully and may require all channels within a given system to be enlarged to accommodate the increased flow. That option should be limited as much as possible.

16 Retrofitting stormwater management

16.1 Introduction

While implementation of stormwater management devices is most easily undertaken during initial development construction, there are many situations where the existing land use may be impacting downstream receiving environments. In these situations, retrofitting stormwater management devices for a given catchment or sub-catchment may be beneficial.

The following section discusses some of the matters to be considered when progressing retrofit solutions to achieve stormwater management outcomes.

16.2 Retrofit process

There are a number of steps to consider when implementing retrofit projects in a given catchment. Figure 16-1 below provides a suggested overall process that can be used to assist with the implementation of retrofit projects.

The first step is the identification of issues that have arisen as a result of stormwater runoff from urban areas across a jurisdictional area.

These issues can then be prioritised based on the lead agencies prioritisation criteria. Some suggested criteria are provided in Section 16.3 below.

Once project prioritisation has been undertaken, feasibility studies would need to be undertaken to determine whether projects are practicable. Feasibility studies should include consideration of the following items:

- Magnitude of impact
- Availability of an appropriate device
- Space availability
- Is there positive drainage to the device?
- Magnitude of benefit
- Cost

These items are discussed in more detail in the following sections.

Once feasibility studies have been completed, a list of projects for implementation will be produced.

It is a good idea to consider whether any of the projects on the list can be wholly or partially implemented (or partially funded) as part of any proposed development proposals that are being undertaken in the vicinity of where the issues are arising.

Final recommendations can then be made as to which retrofit projects are to be implemented.

These projects can then be recommended for funding approval, planning, design and implementation.

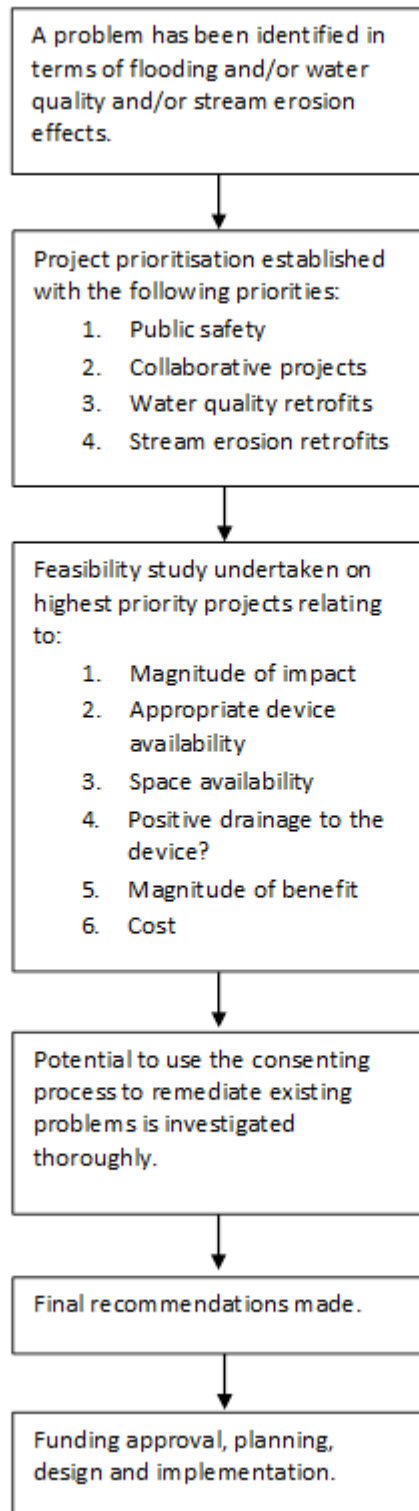

Figure 16-1: Retrofit process

16.3 Prioritisation of projects

When considering the prioritisation of retrofit projects, it is up to the lead agency to determine the criteria used to prioritise the projects, and the subsequent prioritisation.

The following criteria can be used at a macro scale to help prioritise projects with criteria provided in order of highest to lowest priority.

- Projects related to public safety generally have the highest priority. This would include situations where flooding of habitable structures is occurring as a result of upstream urban land use.

- Collaborative projects are to be supported. Having a multi-agency project can provide a better overall outcome in terms of capacity building, improved collaboration and connections moving forward, and potentially higher funding resources being available as the costs are spread over multiple agencies. Overall outcomes can be improved especially where the retrofitting solution addresses catchment problems from varied land uses under the jurisdiction of multiple agencies.
- Projects that address water quality issues have a high priority in terms of managing the effects of urban land use on our regions water bodies. In terms of priority, water quality retrofits can have a beneficial effect on a wider range of receiving environments (streams, groundwater, estuaries, lakes and harbours) than would stream erosion retrofits hence has a higher priority.
- Projects that address stream erosion issues are also of high priority, with primary consideration being given to address local erosion issues and also to projects that address general stream degradation/cumulative effects of upstream urban land use.

16.4 Magnitude of impact

16.4.1 Public safety

If public safety is recognised as an issue in relation to stormwater effects, the project will have a high priority. In terms of ranking within this category, the greater the number of individuals who may be adversely impacted by flooding, the higher up the project would rate on the prioritisation list.

It is important to mention the difference between public safety and property flooding. Property flooding (often due to its location within a floodplain) is not considered a priority for retrofitting.

The following public safety issues are considered a high priority:

- Flooding of habitable structures, or
- Increased flood levels on roads, which could jeopardise public safety.

16.4.2 Collaborative projects

Cross-agency projects to address stormwater issues are supported. Collaboration on solving catchment or sub-catchment issues related to flooding, water quality or stream erosion, ensures that solutions are developed with a broader context and thus providing greater potential benefit.

In terms of prioritisation, projects that provide catchment wide solutions are considered to have a higher priority than projects providing sub-catchment solutions. Joint projects that may be undertaken in conjunction with a specific development project have a lower priority for implementation than the previous two scenarios.

Catchment-wide or sub-catchment-wide solutions will rely on sufficient catchment or sub-catchment studies being undertaken to identify problems and solutions prior to prioritisation of these projects.

While joint projects may be undertaken in conjunction with a private developer, the project needs to have a broader context than just the area of development to warrant consideration for retrofit potential.

16.4.3 Water quality retrofits

Magnitude of impact can be somewhat qualitative in given situations but receiving system impacts can be quantified using contaminant spreadsheets and unit loading approaches. An important issue is the determination that a given receiving system is being degraded either through sediment analyses or via aquatic organism decline. Once that determination has been made and contaminant load modelling or monitoring is undertaken that identifies a given land use as being a major source of degradation, then retrofitting can be prioritised.

The degree of impact is important and will have to be made on a case-by-case basis. The former Auckland Regional Council’s Environmental Response Criteria (ERC)¹⁶⁷ is an example of guidance towards receiving system impact consideration. The ERC are conservative thresholds that provide an early warning of environmental degradation, and they provide guidance as to when intervention may be necessary to protect or mitigate for environmental degradation.

Another factor to consider for water quality retrofit ranking is having a project benefit multiple receiving systems. Providing a water quality retrofit of a given land use that drains into a stream and then an estuary would be given a higher priority than a project that only benefits one receiving system. A variation to this “rule of thumb” would be a receiving system that is much degraded and a retrofit project would have a significant beneficial effect on it.

Retrofit of a dry pond with a small weir to create a wetland



For the most part, water quality retrofits will be undertaken to resolve a locally recognised problem. It is anticipated that local government monitoring (sediment, water quality, aquatic organisms) will provide the background information that retrofitting is responding to.

16.4.4 Stream erosion reduction

Stream erosion can occur as localised erosion or general degradation along a stream reach.

Localised erosion can be caused by inadequate energy dissipation at culvert or pipe outlets and can be relatively easy to resolve through design and implementation of energy dissipation outlet protection.

Retrofit of a culvert with extended detention for stream channel erosion reduction and some water quality benefit



¹⁶⁷ Auckland Regional Council, 2004

General stream channel degradation is more complicated to address, possibly due to increased flows on a more frequent basis. It may be difficult to determine whether a given land use is a primary cause of the degradation. Larger catchments reduce the potential for any one activity to be identified as a principal cause of erosion. The most common situation where a development having a high degree of imperviousness can individually cause channel instability is where the catchment is relatively small and site imperviousness proportionately large. Site imperviousness in excess of 10% of a total catchment area could be a major source of general channel degradation.

Prioritisation should be based on the degree of general degradation.

16.5 Device availability

Device availability depends on the stormwater related problem that is being addressed. The following items consider the types of devices that may be appropriate to mitigate a specific problem.

16.5.1 Downstream flooding impacts

If downstream flooding impacts are identified, the issue then becomes whether appropriate action can be taken to reduce those impacts. There are three devices that are generally appropriate to mitigate downstream flood effects:

- Detain flows using stormwater detention ponds
- Detain flows upstream of cross-culverts to provide flood storage, or
- Purchase or flood proof downstream habitable structures.

If these options are not available, it may not be possible to mitigate the flood effects. If this is the case, further project consideration would be discontinued unless it can be considered cooperatively with another entity, which could expand possible solutions and allow for cost sharing.

16.5.2 Downstream channel erosion effects

There are three key ways that downstream channel erosion effects can be addressed:

- Reducing the volume of stormwater that is discharged, or
- Providing extended detention storage of runoff for 1.2 times the water quality rainfall event using stormwater detention ponds or wetlands, or
- Armour downstream banks to protect banks from erosion.

Infiltration of existing runoff is possibly the only device available for reducing the volume of stormwater. Retrofitting an entire sub-catchment with rain tanks will not normally be practical and may not be effective as much of the runoff is delivered by other impervious surfaces. The suitability of infiltration in a catchment will depend on soils, slopes, depth to groundwater or bedrock and space availability and may not be a practicable option in a given situation.

Another option relates to the provision of temporary storage and release of stormwater runoff for 1.2 times the water quality rainfall over a 24-hour period. The amount of storage required to achieve this needs to be considered on a case-by-case basis for determination of site suitability.

Armouring downstream channel boundaries may address a symptom of the problem more than resolving the problem and is generally considered as a last resort. Armouring channel boundaries may not reduce erosion potential of other parts of the stream, and can displace the erosion effects to the edge of the armoured areas.

16.5.3 Stormwater quality

Providing water quality retrofit will depend on a number of items including the contaminants of concern and the space available to provide stormwater quality treatment.

Table 6-11 lists the treatment performance provided by different stormwater management devices and Table 6-13 provides information about removal efficiencies for different contaminants. If adequate space is available then the following devices are recommended for retrofit to provide water quality treatment, or a combination of these devices:

- Wetlands
- Swales and filter strips
- Bioretention devices or raingardens.

If space is limited then generally a proprietary filtration device is the main option to provide water quality treatment. Or it might be advantageous to use a number of small at-source devices across the area of interest depending on where space is available and what type of devices would suit the available locations. This approach could utilise a range of devices such as raingardens, filter strips, filtration devices and swales, depending on the local constraints.

If space is very constrained, it may be worthwhile to consider providing water quality treatment for the first flush of contaminants only. The topic of first flush is introduced in Section 2.3.3 and is further discussed below.

Some contaminants exhibit more of a first flush effect than others. The first flush may be more pronounced for dissolved metals than particulate ones and will be more pronounced for hydrocarbons. In addition, the shape of the catchment and total area may dampen a first flush effect depending on the catchment arrangement.

A study looking into the effect of first flush events¹⁶⁸ indicates that for a catchment imperviousness of 50%, that zinc has a pronounced first flush effect while copper has a lesser effect. Sediment has a slight first flush effect. The study considered a first flush event to constitute the first 2.5 mm of runoff.

The study also considered the effect of rainfall depth on percent of annual load. For a catchment with 50% imperviousness the following table presents the zinc and copper contaminant levels in different depths of runoff as a percentage of annual load.

Table 16-1: Zinc and copper contaminant levels in runoff¹⁶⁸

Contaminant	% of annual load				
	Runoff Depth Interval (mm)				
	0 - 2.5	2.5 - 7.6	7.6 - 12.7	12.7 - 19	19-25
Zinc	40	36	11	4	9
Copper	21	39	20	6	14

As can be seen, capturing the first 7.6 mm of runoff may provide a significant reduction in annual load for zinc and copper.

If these metals are the primary contaminants of concern for a retrofit solution and space is constrained, the findings of this study suggest that targeting the first flush for treatment may provide a reasonable outcome in terms of reduction of the annual loads for these contaminants.

It is important to recognise that this 'first flush' approach does not achieve the same level of contaminant reduction that is intended for new development but in situations where there is less available space and a specific contaminant can be targeted, benefits can be achieved. Water quality treatment in an existing urban environment is as much a result of opportunity as it is about criteria.

¹⁶⁸ Minton, 2002

16.6 Space availability

Availability of space to retrofit stormwater management is an important aspect of the decision matrix. Space has to be available or retrofitting cannot be undertaken.

Any device that is constructed will eventually need maintenance and that maintenance can only be undertaken if access to the site for maintenance purposes has been provided. An essential element of any retrofit project design is the need to consider future access to the device for maintenance equipment.

Undertaking a collaborative project with multiple agencies or even with a developer may provide the required space. In general, retrofitting is more practical when considered as a collaborative project than attempting to reduce effects individually.

16.7 Positive drainage

While there may be space available to retrofit a stormwater management device, gravity may prevent a given location from being feasible.

Elevation differences may mean that an available area is not located down-gradient from where the runoff is generated and hence runoff cannot be directed to the location.

In addition, existing development will have a reticulated system to discharge stormwater downstream and that drainage system may not allow for flows to drain to a stormwater management device.

The existing site drainage system and site topography have to be considered to determine whether a retrofit is practical.

16.8 Magnitude of benefit

The ability of a retrofit to individually, or in conjunction with other efforts, reduce existing adverse effects to receiving systems must be considered.

The decision whether a given contaminant reduction provides value to a receiving system depends on a case-by-case analysis of monitoring data and modelling of long-term effects. In many situations, retrofit will be considered in response to a local problem identification but retrofitting actions should also be considered from a catchment-wide perspective.

The magnitude of the benefit cannot be considered until a decision is made regarding whether a device can be used at a given location and what level of contaminant reduction can be provided. Once those questions are answered, the magnitude of benefit from the proposed retrofit device can be assessed.

16.9 Cost

Cost is another important component of the retrofit approach. It can be considered from several different perspectives.

- Cost versus magnitude of benefit for a given project
- Total cost for a given retrofit, or
- Total cost for the overall retrofit programme.

16.9.1 Cost benefit analysis

A cost benefit analysis is recommended to determine whether a retrofit can provide a benefit to a receiving system. It may be that removing only 10% of a given contaminant will provide only a minor improvement to receiving system health unless undertaken in conjunction with other projects that are programmed or intended.

Once the decision is made that a given retrofit project will result in a measurable improvement to receiving system health, the cost of that improvement must be determined and considered against the benefits provided.

When financial resources are low, it can be difficult to justify expenditure that addresses stormwater related issues beyond those that ensure public safety. Providing value to aquatic receiving systems is not well defined and tends to be more qualitative than quantitative, and has often been over-looked.

However in the Waikato Region, as discussed in Section 3, the Waikato Regional Policy Statement (RPS) gives effect to the Vision and Strategy for the Waikato River which has overarching objectives that include:

- The restoration and protection of the health and wellbeing of the Waikato River, and
- The restoration of water quality within the Waikato River so that it is safe for people to swim in and take food from over its entire length.

The RPS is the primary direction-setting document for the Waikato River and its catchments and provides clear direction that helps to justify retrofit solutions that help the objectives of the Vision and Strategy to be achieved.

16.9.2 Total cost

While a given project may be feasible from a design and space allocation perspective, the overall cost of project implementation and operation may make a project impractical. There are several examples of this as follows:

- Due to slopes and space availability, a retrofit may require retaining walls to fit in a confined space. While there would be water quality benefit, the cost to construct the device would be very high. In those situations it may provide greater benefit to do several other projects than the one being considered.
- If space is limited, design could be based on providing a smaller surface area for treatment than would normally be recommended for a new consented activity. This would necessitate maintenance on a more frequent basis. If there are maintenance access problems the whole-of-life costs may be too high to justify project implementation.

To some degree, the final decision will be based on a qualified determination of benefit but the feasibility process provided here will allow greater quantification of benefits versus cost to assist in reducing uncertainty in decision-making.

It is important that project cost reflect whole-of-life costing rather than just construction. Whole-of-life costing will reflect the long-term cost of maintaining continued function in addition to design and construction. This is critical in areas where space is limited and maintenance access may require road closure or work being undertaken at night versus during the day.

16.9.3 Total cost for the maintenance programme

This is an item that needs to have a basic assured funding base so that continuing efforts may be undertaken. Without having a dedicated funding source proactive approaches cannot be undertaken. Too often local programmes are focused on requesting funding to address a specific problem without having a proactive approach to problem solving.

It is important that operation and maintenance is assured so that investigations and prioritisation of actions can have a solid foundation. Relating actions to specific catchments will offer a comprehensive approach to problem solving by highlighting problem areas, identifying those stressors that cause the problem and considering options for solution. These activities cannot be undertaken without assurance of funding on a long-term basis.

Stormwater pond being maintained by having the silt sucked out by vacuuming



16.10 Taking advantage of opportunities

Retrofitting presents many unique, complex challenges – institutional, technical and financial. Institutionally, retrofitting is best accomplished through catchment approaches. Technically, a given approach may be land intensive and inappropriate for use in highly urbanised areas, where land is scarce and expensive.

It is important to have good communication and coordination between all of those entities involved in a given project, and this needs to be occurring early in the problem identification process to avoid conflicts and to allow for synergies to occur. Retrofitting can be undertaken through an almost limitless number of ways. These include the following:

- Retrofitting existing stormwater quantity control structures
- Using existing road crossings to impound stormwater
- Demonstration projects
- Use of new consenting to exceed individual project benefits, and
- Retrofitting through education.

Restoration of an Urban Stream in Christchurch in Association with Community Walkways



16.10.1 Retrofitting existing stormwater quantity control structures

Nearly any modification of an existing runoff control device which will slow velocities, increase detention time or promote runoff flow through vegetation will increase the removal of

contaminants. The simplest way to retrofit stormwater detention ponds is to modify the existing outlet structure to provide extended detention or provide a normal pool of water for a wetland.

If site conditions are appropriate, dry detention or failing infiltration systems can be converted to wet systems to improve contaminant capture. Any permanent pool may have to be excavated below the existing device invert so the storage volume is not reduced. A retrofit could be as simple as adding a weir above the invert of a pipe to provide for some detention of water.

16.10.2 Using existing road crossings to impound stormwater

Roads and highways, by their linear nature cross catchment boundaries. Where they pass over drainage systems there is generally an embankment that elevates the roadway above a given floodplain elevation. The upstream inlet of the highway can be modified to extend detention time.

Grassy medians, shoulders, clearways and interchanges all provide opportunities for retrofitting for water quality treatment. Obviously, these options would have to be coordinated and approved by the appropriate road or highway responsible entity (territorial authority, NZTA, land owner, etc.).

16.10.3 Demonstration projects

Retrofitting is often undertaken as a demonstration project. It provides an opportunity not only to treat stormwater but to test innovative treatment devices. They tend to be limited to showing examples of innovative devices in a forum where they are visible. Visibility is important when the intention is to increase public awareness of stormwater management proactive or to have people become aware of devices that may be promoted on a more widespread basis (possibly water tanks).

The value of demonstration projects as an educational tool can be very important. Auckland Council has established a stormwater themed area at the Auckland Botanic Gardens in Manukau City where people can see stormwater management devices and learn more about them from interpretive signs.

There are many opportunities to make the public more aware of stormwater management issues.



Figure 16-2: Auckland Council stormwater demonstration area

16.10.4 Use of new consenting to exceed individual project benefits

A new development may provide an opportunity to incorporate some retrofitting as a cost share initiative or provision of adjacent area retrofit as a consent condition. It may be that an increased density could be allowed for land that may provide broader treatment than for an individual development.

An example could be when a road is widened and treatment must be provided for the new section of carriageway. It may not be possible to split the new road section from the existing road section and hence treatment can be provided for the whole road including the portion of existing carriageway. This would improve on the existing situation.

16.10.5 Retrofitting through education

Public education can result in a significant improvement to catchment management outcomes. Every day activities add contaminants to streets, parking lots, lawns and other surfaces. Public education campaigns highlighting the importance of our waterway, the connectivity of stormwater systems to our waterways, the importance of reducing contaminants that reach the stormwater system can be an effective retrofitting tool.

Possible topics for education campaigns can include:

- Caring for our streams
- Correct disposal of household chemicals and automotive waste
- Proper use of lawn fertiliser and pest control chemicals
- Correct disposal of lawn clippings and green waste (not throwing them into streams or gullies)
- The benefits of water tank installation
- The benefits of washing cars on grass rather on driveways or the road, and
- Avoiding littering (including picking up dog droppings).

Public education can also increase the effectiveness of spill readiness programmes, through activating the community to assist with notification of when spills occur. By increasing awareness of contaminant indicators and having a simple notification system in place, spill events might be more readily noticed and reported by the community, hence the spill can be contained and managed more efficiently by officials, reducing potential effects on the environment.

Environmental education in existing urban areas can provide one of the most practical and cost-effective approaches to contaminant reduction.

A key point in considering public educational programmes is that they must be ongoing. If a programme is presented for a limited time the public often slips back into old habits that can cause contamination. Public education programmes will only provide long term benefits if they are ongoing.

Part IV: Construction, operations and maintenance

17 Construction related issues

17.1 Introduction

Effective planning, good design, good construction, maintenance inspection and operation and an understanding by all of those involved in the total process are essential elements of successful stormwater management programme implementation. A breakdown in any one of these areas will cause additional expenses that would not arise if all steps were undertaken correctly. The best design plan has little value if the device is not constructed properly. The use of poor quality materials for construction and poor construction in general can negate all of the time and effort expended during the design phase.

Problems associated with poor construction range from minor to major.

Minor problems can include partial premature clogging of a filtration or infiltration device, premature maintenance needs related to sediment removal, replacement of a device component such as riprap, slope erosion or standing water (where there is not supposed to be any).

Major problems could necessitate reconstruction of an entire device, structural repairs or increased safety concerns.

Proper construction will have a significant beneficial impact on future maintenance.

Construction inspection can be broken down into several components¹⁶⁹ including:

- A clearly defined responsibility for proper construction
- Pre-construction activities
- Device construction, and
- Final acceptance responsibility.

These items are discussed individually to provide guidance on successful construction of stormwater management devices. Any inspection forms that are completed should remain with the project files in the event that to resolve future maintenance issues they need to be referred to.

17.2 Responsibility for construction

There has to be an individual who has the assigned responsibility for proper construction of stormwater management devices. That individual must have authority, or be given a defined approach to construction problem resolution. This is to ensure that construction is undertaken correctly and that any required changes are made if the quality of any portion of a device construction is undertaken less than adequately.

A variety of problem resolution options must be available to the responsible individual and could include items such as:

Bioretention construction - sediment entry is compromising future performance



¹⁶⁹ Watershed Management Institute, 1997

- Completing an inspection report and providing the report to the contractor that lists stormwater management device status
- Issuing a notice of non-compliance that documents a problem and the need for rectifying it
- Non-payment for items undertaken incorrectly or poorly
- Not allowing other work to progress until the stormwater device construction issue is resolved
- Penalty provisions for failure of a contractor to make any necessary changes if the device is not being undertaken according to design, or
- Limiting ability of a given contractor to work on other jobs if the construction problems are not resolved.

The approach to problem resolution is progressive to provide the contractor with adequate opportunity to make corrections before the issue becomes adversarial.

The responsible person must have the necessary backing to ensure that stormwater devices are constructed according to approved plans.

A variety of options for ensuring proper construction are needed and one option may be more effective with a given contractor than others.

The obvious intent is to start with a cooperative approach and only increase pressure, as it is needed.

In most situations, the contractor will make the necessary changes, however Waikato Regional Council or the relevant territorial authority will take action if required, as future allocated maintenance funding will depend on having proper construction. It is in the region's best interest to ensure that construction is undertaken correctly.

Having a variety of problem resolution measures available does not mean that they will be taken, and once a contractor becomes aware that the issue is serious, the overall quality of construction will be improved.

Pond failure resulting from lack of anti-seep collars around outlet pipe



Senior project staff must be briefed when there are problems with implementation of stormwater management devices. A good approach may be to establish a minor/major list of actions that can be taken by either the responsible person or issues that need to be addressed at a higher level.

Minor infractions could include the following:

- Poor quality control of stormwater devices during construction
- Use of structural materials that are sub-standard, or
- Minor construction infractions that have not been corrected as requested in inspection reports.

Major infractions could include the following:

- Contaminant related incidents

- Major non-compliance with consent conditions or approved plans, or
- Continued refusal to make necessary field changes.

17.3 Pre-construction activities

The individual responsible for proper construction of stormwater management devices should:

- Review the approved design plan to become comfortable with all of the plan components, and
- Conduct a pre-construction meeting with the contractor.

The review of the design plan should include the following:

- The overall project proposal and site conditions
- Location of the stormwater management devices
- Location of the existing or proposed drainage system
- Dimensions of the stormwater devices
- Any construction problems that might be anticipated
- Any special consent or approval conditions
- Material specifications
- The sequence of construction, and
- Any right-of-way limitations or restrictions.

The pre-construction meeting is important to ensure that the contractor has a good understanding of key aspects of device construction and the need for proper construction. The meeting assists in the development of a dialogue between the contractor and the responsible person. Other individuals having roles in stormwater device construction also should be included, especially subcontractors and individuals responsible for any utility construction.

Items that should be discussed at the pre-construction meeting include:

- Contact information (cell phone, email, etc.)
- Importance of having design plans on site
- The purpose of the stormwater management approach
- Specific design details that require special attention
- Safety briefing/traffic management
- Construction sequences, schedules and timetables, and
- Chains of command in the event that field changes become necessary.

17.4 Device construction

As stormwater management devices are varied in their composition, shape and form it would be best to address construction individually. Much of the information provided in this section is from Auckland Regional Council's TP10.

17.4.1 Swale and filter strip construction

A key requirement of any vegetative treatment system is to obtain a stand of vegetation that can effectively filter stormwater runoff. Ideal vegetation characteristics include a dense, uniform growth of fine-stemmed plants that can tolerate soil saturation and the climatological, soil, and pest conditions of the area. Catchment areas are generally fairly small, less than 4 hectares.

It is essential to maintain proper hydraulic conditions to avoid uneven, channelised flows through the swale or filter strip. Uneven flow across its width reduces contaminant removal because runoff bypasses vegetation, shortening treatment time. Channelised flow also may erode swales or filter strips, exacerbating the downstream water quality problems that they were intended to mitigate.

Swale construction showing erosion protection until vegetation has become established



Swale with vegetative stabilisation following construction completion



17.4.1.1 Important design inspection aspects

Design of swales and filter strips is fairly straightforward. Their primary treatment process is filtering runoff through vegetation. It is important to note the following important design aspects of swales and filter strips:

- The bottom width of swales should be no less than 600 mm if it is to be mowed and no greater than 2 metres to prevent concentration of flow.
- Sequence of construction for overall site development and construction of the swale and filter strip.
- Do the post-development drainage patterns resemble the pre-development ones? Placement of swales and filter strips along natural flow paths and contours should be detailed on the approved plans.
- To assure even sheet flow in a swale or filter strip and avoid channelised flow, the bottom must be flat with no lateral slope across the bottom of the swale or vegetative filter strip.

- The design of inflow to the swale or filter strip should quickly dissipate runoff velocity to minimise erosion potential. Dissipation devices such as riprap pads and level spreaders should be used.
- Outflow from swales and filter strips should either be diffuse (to avoid erosion damage to downstream facilities or water bodies) or into a stable conveyance system. Swales may be equipped with raised storm drain outlets to prevent erosion.
- Generally, swales should be longer than 30 metres to reduce short-circuiting, with their total length depending upon the flow and the 9-minute minimum required residence time. No minimum width has been established for filter strips since this is a very site-specific design parameter. These dimensions must be specified on the approved plans.
- Longitudinal slopes should be fairly slight, with maximum slopes of 5% (can be greater with use of check dams if the check dams reduce slope to 5%).
- Plant specifications must be on the approved plans. Grasses tend to be the superior choice of vegetation as they are resilient, somewhat stiff and dense, provide abundant surface area and can sprout through thin deposits of sand and sediments.
- Pre-treatment should be provided when high sediment inputs to swales or filter strips are likely.

Level spreader installed to ensure dispersed flow through the swale base



17.4.1.2 Important construction inspection aspects

Construction activities should be phased to ensure the greatest practical amount of plant cover during the course of construction. If permanent swales and filter strips are installed during site construction, they either must be protected from construction site runoff or restored for long term use once site construction is completed. The following important aspects of construction should be noted:

- Stake out site location for the swale or check dam to allow for dimensions, shapes, and slopes to be verified per the design plans.
- Ensure that lateral slopes are completely level to avoid any tendency for the flow to channelise.
- Ensure that inlets, outlets, and other auxiliary structures such as check dams or flow bypasses, are installed as specified.
- Make sure that vegetation complies with planting specifications. Ensure that vegetation becomes uniformly dense for good filtration and erosion protection. Seeding or using sod can establish grass. Seeding is generally preferred due to its lower cost and the greater

flexibility it allows in selecting grass species. The method of vegetative stabilization should be discussed and approved at a pre-construction meeting.

- Place the swale or filter strip so that no portion will be in the shade of buildings or trees throughout the entire day, as this will cause poor plant growth.
- Make sure that construction runoff is not entering the swale or check dam. If it is, require removal of sediments and re-establish vegetation upon the completion of construction.
- Ensure that measures are in place to divert runoff while vegetation is being established. If runoff is probable and cannot be diverted, ensure that adequate erosion control measures are in place.
- Inspect liners, underdrains, riprap, and check dam spacing, if these are included in the approved plan.
- Make sure that any level spreaders are completely level and stable enough to remain level during their operation.
- Check for proper installation of pre-treatment devices, if required.
- Ensure that kerb cuts and their locations are as specified.

17.4.2 Sand filters

Sand filters may involve reinforcing steel, concrete, significant site preparation and excavation before construction. The approved plans should be reviewed and discussed for any concerns at the pre-construction meeting. The following construction times and items are important to recognise during the site inspection:

- Stake out the sand filter location.
- Generally, do not use sand filters for sediment control during construction.
- Pre-fabricated structural components should be available on-site to verify adequacy of materials. Reinforcing bars should meet design specifications, as should all other structural components such as any pipes, aggregate material and filter fabric.
- Clear foundation areas of any organic material, which could cause uneven settlement as the material decomposes. Unsuitable foundation material should be removed and replaced with suitable material.
- Compact the foundation area to sustain the load placed on it by the sand filter. Level the foundation as detailed on the plans to ensure proper drainage of the facility.
- Ensure the responsible person is on site when the sand filter has been formed up with reinforcing bars in place but before pouring the concrete so pouring can be observed.
- During concrete pouring, the responsible person must verify that the concrete meets design specifications for the design load.

Sand filter under construction



- If the sand filter is composed of prefabricated units, the inspector must approve the means of joining the sections and the steps taken to prevent leakage from between the prefabricated units.
- Before backfilling, fill the filters with water once the concrete has set (or joints on prefabricated units have been sealed) and allowed to sit for 24 hours and observe whether the unit has any leaks.
- When installation has been completed to meet size and volume requirements, has no leakage and the contributing catchment areas have been stabilised, place the underdrains on the proper slope and wrap them in filter fabric to prevent migration of the filtration material out of the facility.
- Place the filter material in the facility. The material should meet criteria specified on the design plans. The sand should be clean, washed aggregate.
- Conduct a final inspection to verify that the filter material is placed correctly and the first sedimentation chamber is clean of any accumulated sediments or other construction debris.

17.4.3 Bioretention devices

- Ideally, defer building the bioretention device until after the contributing drainage area has been stabilised.
- Do not use the area excavated as a sediment ponding area during site construction, as finer sediments may seal the bottom before it starts operation.
- Stake out the general location of the bioretention device so that location and dimensions can be considered in terms of site suitability.

Bioretention device - lining around garden and perforated underdrain prior to backfilling



- Excavate the bioretention device and connect the underdrains to the stormwater drainage system. If there is no stormwater system, the underdrain should be connected to a flow distribution system to avoid concentrated flows downstream. Impervious lining or filter fabric should be placed at this time.
- Place gravel backfill, sand backfill and planting soil in excavation. Verify composition of materials and compaction.
- Plant vegetation, lay mulch and complete site stabilisation.

17.4.4 Infiltration

17.4.4.1 Infiltration trenches

Infiltration trenches can be up to several metres deep, with a large length to width ratio. Filled with stone, scoria, gravel or sand aggregate, they are generally used in areas where space available for stormwater management is limited.

Runoff is stored in the voids of the aggregate material, which are normally is between 30 and 40% of the total volume. Scoria has a higher void space ratio of approximately 50%.

The stored runoff then exits the trench through the side and bottom walls into the ground. Construction inspection should include the following items:

- Verify the infiltration trench dimensions and location on site before trench construction. Verify distance to any building foundations, septic systems, wells, etc.
- Excavate the trench using a backhoe or a ladder type trencher. Front-end loaders or bulldozers should not be used, as their blades can seal the infiltration soil surface. Place excavated materials far enough away from the sides of the excavated area, in order to minimise the risk of sidewall cave-ins and prevent migration of the soils back into the trench after the stone, gravel, or sand aggregate has been placed.
- Inspect the trench bottom and sidewalls and remove objectionable material such as tree roots that protrude and could possibly puncture or tear the filter fabric.
- Line the sides and bottom with filter fabric. The sidewall fabric will prevent migration of soil particles from the sidewalls into the trench. The bottom fabric will prevent sealing of the aggregate soil interface.
- Lay the fabric with sufficient length to overlap the top of the trench. Covering the trench after placement of the aggregate will protect the completed device by preventing excess site sediment from entering it.
- Install an observation well in the aggregate so that future inspections can determine whether the device is functioning as designed. The observation well should consist of a perforated PVC pipe, 100 - 200 mm in diameter and have a footplate and a cap. The footplate will prevent the entire observation well from lifting up when the cap is removed during future inspections.
- Inspect the aggregate material before placement to ensure that it is clean and free of debris. The size of the material should be as specified on the approved plans.

Infiltration trench - footplate and observation well



Infiltration trench backfilled with stone



- Upon completion of trench construction, the adjacent areas should be stabilised with vegetation. Direct the trench overflow to a non-erosive outlet channel.
- Install a pre-treatment device such as a swale or other approved method before the runoff enters the trench in order to remove suspended solids.
- Cap the observation well and measure and record the initial depth measured and noted on the inspection checklist.

17.4.4.2 Soakage Pits

Similar to infiltration trenches, soakage pits are excavated areas that are filled with an aggregate material. The main difference is that soakage pits accept runoff from roof areas only. They therefore receive lower loadings of suspended solids than from what would be expected from ground surface runoff.

The major concern with soakage pits is their proximity to building foundations. Careful consideration must be given to the correct placement of them so that building foundation problems do not occur.

Construction inspection should include the following:

- Verify the soakage pit dimensions and location on site prior to construction. Verify distance to foundations, wastewater systems, wells, and utilities.
- Excavate the soakage pit using a backhoe or ladder type trencher. Front-end loaders or bulldozers should not be used as the equipment blades may cause compaction of the soakage pit floor.
- Place excavated materials a sufficient distance from the sides of the excavated area to minimise sidewall cave-ins and to prevent migration of the soils back into the pit after the aggregate has been placed.
- Inspect the soakage pit bottom and side walls and remove objectionable material.
- Line the sides with filter fabric to prevent migration of soil particles from the side walls into the pit.
- Install an observation well in the aggregate to allow for future maintenance inspections to determine functioning over time.
- Inspect the aggregate material before placement to ensure that it is clean and free of debris. The size of the material should be as specified on the approved plans.

17.4.4.3 Permeable pavement

These devices create road and parking lot surfaces that allow for stormwater runoff to travel through the surface into the ground. Under the porous surface, an aggregate material serves as a reservoir base for temporary storage of the runoff until the water infiltrates into the ground.

Their best applications are in areas where there is a low volume of traffic or where overflow parking is needed on a periodic basis, and where subsoils have not been so compacted as to reduce the infiltration rate to below 7 mm/hr.

Lattice block is a modular unit which is generally placed in square sections. It is concrete with large void areas which are filled with a porous material, such as sand or pea gravel. Lattice block still should have filter course, reservoir course and filter fabric lining, prior to entry into the soil. Construction inspection should include the following items:

- To help preserve the natural infiltration rate of the subgrade soils prior to excavation, prevent soil compaction of the infiltration paving area by heavy construction equipment. The area should be marked off and traffic kept off it to the greatest extent possible.
- Verify the infiltration paving dimensions and location on site before construction. Verify distances to foundations, septic systems, wells and utilities
- Carefully excavate the area of the paving to prevent excessive compaction of the soils during the sub-grade preparation. All grading should be carried out using wide tracked equipment.
- Once the sub-grade has been reached, place filter fabric on the bottom. The type of fabric should be specified on the approved plans. Once the fabric has been placed, place the reservoir course to the design depth. This course should be clean, washed stone having a void ratio between 30 and 40%. Lay the reservoir course in 300 mm lifts and lightly compact it. Spread aggregate uniformly.
- Place the aggregate filter on the reservoir course using clean washed stone ranging in size from 10 -20 mm This stone provides a uniform base for the lattice course.
- Never let sediments enter the infiltration paving construction area.
- Lay the surface course. Fill the void areas of the lattice block with the appropriate specified material.

17.4.5 Ponds and wetlands

Most of the information on wet ponds is directed towards ponds where the normal pool of water is established by the construction of an embankment. Excavated ponds typically do not have the same safety concerns related to embankment failure.

When constructing wet ponds, it is very important to regularly inspect for seepage through the embankment. Ponds with a normal pool of water develop a zone of saturation through the embankment, which can increase failure potential in the future. Concerns regarding this zone of saturation (frequently detailed on plans as the area below the phreatic line) are alleviated by good quality control during construction.

Requiring, during design, safety features in the embankment that reduce the movement of water through the embankment, reduces the risk of a potential hazard. These safety features include anti-seep collars, diaphragms, core trenches and clay cores. These features are not visible once construction is completed. The responsible person must verify their construction and quality of construction during their installation. Failure to inspect these features at critical times may result in embankment failure in the future.

Pond core trench - to reduce seepage and prevent embankment lateral movement



Detention or retention devices, which are normally dry, do not develop a zone of saturation (which results from standing water) and internal water seepage is not a critical concern.

17.4.5.1 Important inspection aspects related to design

When certain site conditions are encountered or where the design has an unusual aspect, it is important to keep in regular communication with the appropriate professional (geotechnical, structural, etc.) to avoid some common mistakes. Examples of items which should be discussed include:

- Encountering sandy soils when building a wet pond designed with a normal pool of water when the plan does not specify a pond liner.
- Stormwater inlets too near the intended outfall, thereby short-circuiting flow to the outlet. While this may be acceptable from a stormwater quantity perspective, the short-circuiting will reduce treatment and lessen water quality benefits.
- Steep slopes into the pond with no slope breaks (benches) can increase the hazard potential and erosion of side slopes.
- Failure to include on the plans essential components normally associated with ponds, such as anti-seep collars, trash protection for low flow pipes, service and emergency spillways.
- Failure to include a draw down mechanism in wet ponds. Ponds having normal pools should have a means to draw the water level down should draining the pond become necessary. From a responsible person's viewpoint, a wet detention pond without a draw down mechanism should be brought to the attention of the designer. Where groundwater provides the permanent water pool, a draw down mechanism won't be available. The responsible person should know the expected or design ground water elevations at a site, especially the seasonal high level. This information should be on the approved plans.

**Pond drain to draw down water for emergency
or maintenance needs**



17.4.5.2 Important inspection aspects related to construction

This section highlights important things to inspect during the construction of ponds.

- A major cause of pond failure is soil piping - water travelling along the outside of the service spillway. It generally occurs along an outlet pipe where water, which is under pressure from the depth of water in the pond, causes erosion of soil adjacent to the pipe. Erosion of this material causes the pond embankment to be weakened at that point and failure of the embankment results. This failure is much more likely to occur in wet detention ponds than in normally dry ones because they have a permanent pool of water next to the embankment.

**Vibratory compactor being used to compact material
around the outlet pipe with anti-seep collar**



- Water will soak into the embankment and seek a lower elevation. Failure potential can be prevented by proper installation of anti-seep collars or diaphragms, in conjunction with proper compaction of soils adjacent to the service spillway and collars or diaphragms.
- The general minimum standards for construction work also apply to the construction of stormwater ponds. Does the construction comply with local material and equipment requirements for earthwork, concrete, other masonry, reinforcing steel, pipe, water gates, metal and woodwork?
- Are interior and exterior side slopes no steeper than 2.5:1 (horizontal to vertical)? The reason most stormwater embankment ponds remain stable is that the mass of earth in the embankment is heavy enough to prevent slippage of material caused by water pressure on the upstream slope. Steep side slopes are not only more dangerous to the general public, but they also reduce the total mass of earth material in the embankment. This can increase the potential for embankment failure.

Construction of outlet pipe on a concrete cradle



- Are elevations relatively accurate and according to the approved plans? An inspector should carry a simple Locke level to determine whether a given location is at proper elevation. The invert elevation of a service spillway must be lower than the elevation of the pond embankment or trouble can be expected. A Locke level provides a quick, moderately accurate, means to verify field implementation.
- Are inlet and outlet areas stabilised to prevent erosion? Relying only on vegetative practices for stabilisation is generally inadequate since it takes time for the vegetation to become well established. Some form of additional stabilisation technique is generally necessary to protect soil until vegetation is established. This can include erosion control matting, riprap, gabions, and the like.
- Are safety features provided? These may include the shallow bench surrounding the pond edge, barrier plantings to discourage approach by children, and/or fencing where required.
- A sequence of construction must be established and followed. It is just as important that construction be undertaken in the correct order, as it is to have good quality construction. The sequence of construction includes pre-construction meetings, temporary erosion and sediment control, core trench, and so on.
- Upon completion of construction, a final inspection should be performed. This inspection provides written documentation to the developer/contractor of the satisfactory completion of the facility. Depending on regional or local council requirements, this inspection augments the submission of an As-built plan.

17.4.6 Green roofs

Due to the lack of overall expertise in construction of green roofs, care must be taken with each phase of construction. The following items must be followed to ensure that construction problems are eliminated and long term performance is maximised.

- The roof that is placed prior to installation of the waterproof membrane must be clean. All debris, nails, screws, stones, etc. must be removed and the overall roof must not have potential to puncture the lining.
- As the green roof may have substantial weight, the structural integrity of the support system must be checked throughout the construction phase to ensure that there are no structural weaknesses that would cause a partial or full failure of the structural support.
- Slope is an important element of the roof and construction shall ensure that the design slope is maintained and not increased.
- The waterproof membrane must be of high quality and checked over carefully to ensure that there are no potential weak spots or rips that would compromise the integrity of

the membrane. When installing nails, screws or cutting implements must be kept off the roof.

- If there are any pipes, vents, chimneys or flues that are in the green roof area, the waterproof membrane must be carefully placed around them and sealed to prevent these areas from becoming sources of leakage.
- Once the waterproof membrane is installed, a water test should be undertaken where water can be pooled on the roof for approximately 24 hours to check for any leakage.
- Regarding the drainage layer, ensure that there are no imperfections in the mat and where two mats abut each other, there should be a minimum of 100 mm overlap.
- The substrate must be checked to ensure that it complies with the design specifications listed in Section 8.5.8. The method of getting the substrate onto the roof shall be discussed at the pre-construction meeting and shall receive council approval of the method.
- Once the substrate is placed, foot traffic across it should be minimised to prevent compaction.
- Planting shall be undertaken according to the design recommendations and shall be undertaken either from late autumn to early spring to improve propagation. If not undertaken during this time of year then irrigation will be necessary to ensure survival.

A good reference document for guidance on the construction of green roofs is Auckland Council's *'Construction of Stormwater Management Devices in the Auckland Region, TR2010/052'*¹⁷⁰.

17.4.7 Water tanks

There are five components to water tanks that are used for stormwater management purposes as listed below:

- Gutters and downspouts
- The tank itself
- The pipe system that conveys water from the tank to site usage
- An overflow conveyance for times when the tank is full, and
- An outflow orifice when some portion of storage in the tank is used for detention of stormwater runoff.

As almost all tanks are pre-constructed and delivered to the site as a single unit, much of the water tank construction discussion will be on placement rather than on actual construction.

The following items should be considered when a water tank is placed on the site:

- How will the tank be placed at its desired location?
- The location should consider trees and other vegetation that could impact on long term function of the tank.
- The tank should be placed in a location where maintenance access can be easily provided.
- The tank has to be placed on level ground and secured to the ground if there is potential for movement during high wind events.
- If the tank is intended on being buried, any utilities should be located prior to placement of the tank and those utilities should be avoided. In addition, local seasonal groundwater levels should be determined to avoid any floatation concerns.

¹⁷⁰ Auckland Regional Council, August 2010

- If a tank is to be buried the tanks structural integrity shall be verified for burial.
- The design plans shall be consulted if the tank is being used for detention of runoff. The elevation and diameter of outlets from the tank must comply with the design.
- The gutters and downspouts draining into the tank shall have protection to ensure that leaves or debris cannot get into the tank.
- The tank shall have an access port that is easy to access for maintenance or for additional water delivery if domestic use is an issue.
- If the tank delivery system can potentially have a cross-connection with a public water supply, appropriate plumbing will be required and will require a building consent under the Building Code.
- All water tanks shall have an overflow means for times when the tank is full and additional stormwater cannot be accommodated. The overflow device shall be discharged in a non-erosive manner to an appropriate outfall.

17.4.8 Bush revegetation

Planting native bush can improve environmental outcomes while at the same time add value to property. Native bush can make a landscape more attractive, provide shade, shelter and habitat for wildlife and stabilise steep slopes.

The following items are important to implement when planting native bush as a component of an overall stormwater management system:

- The area where bush is to be planted should be staked to minimise potential for vehicle compaction of soils. If extensive site re-grading is done, the soils should be rehabilitated prior to planting.
- If planting is being undertaken in an area that has pasture grasses, long grasses should be removed. It may be more effective to spray the area several weeks prior to planting.
- Planting should be undertaken from mid-May through to September although in areas with heavy frosts, spring planting is preferable. Plants should be kept cool and moist until planting is done.
- Planting should be undertaken according to a planting plan that has been prepared during the design phase.
- Holes should be dug slightly larger and deeper than the size of the root-ball. If the soil is hard, dig the spade into the bottom of the hole several times to break up the soil. Position the tree in the hole so the stem is just below ground level to allow for approximately one centimetre of soil to be placed on top. Fill the hole with loose soil and press down with your foot.
- In open field areas fertiliser should be composted into the bottom of the hole before planting.
- Maintenance should be undertaken for several years after planting to reduce competition from weeds and grasses.
- If there are possums or rabbits in the area, a pest control programme should be implemented to protect the plants.

17.4.9 Oil/water separators

Oil/water separators are prefabricated units that would arrive at the construction site in one piece. There are several key issues related to their proper installation as follows:

- The sub-grades must be compacted to acceptable standards to prevent any uneven settlement of the separator, which would impact on performance.

- The grades must be as shown on plans to ensure proper outfall to the downstream receiving system.

17.5 Final acceptance

Final sign-off of a completed stormwater management device should only be undertaken when an As-Built plan of the device has been submitted, reviewed and the completed device accepted. The As-Built plan is vital to long-term operation as it forms the basis for the completed device and the level that will be re-established when maintenance is undertaken.

17.6 Inspection reports and construction notes

It is a requirement that the stormwater management construction related information be retained in the project file. This is to ensure that this information can be referred to in the event that operational issues occur and historical information related to construction may be necessary to better understand why a given operational element has become a problem. This applies to unforeseen problems such as quality of materials or excess seepage out of a device, and does not apply to normal maintenance activities where contaminants are removed from a device, or mowing or plant maintenance is undertaken.

It is also recommended that the site file contain a record of all stormwater management devices in terms of construction dates, type of device and any unforeseen problems that occurred during construction.

17.7 Construction inspection checklists

Appendix A has an example of a pre-construction meeting checklist that can be used to ensure that all pertinent issues are discussed prior to initiation of construction.

In addition, checklists have been included in Appendix A for stormwater management devices to ensure that inspections are undertaken at critical times during construction to maximise potential for effective function.

18 Operation and maintenance

18.1 Introduction

Once construction has been completed the long-term assurance of adequate stormwater management device performance is initiated. Stormwater management devices are expected to perform their water quality and quantity management functions as long as the land use they serve exists. There are a number of reasons why this continued function is important, as follows:

- Maintenance is necessary to ensure outcomes that the devices were constructed to achieve are, in fact, achieved,
- Public safety may be compromised if maintenance is not undertaken, and
- The stormwater management devices may be required by an RMA consent and the eventual property owner will have a legal obligation to ensure continued device function.

From a stormwater management context, failure to maintain stormwater management devices may result in the following impacts:

- Increased discharge of contaminants downstream
- Increased flooding downstream
- Increased downstream stream channel instability
- Potential loss of life or property, resulting from a device failure, and
- Aesthetic or nuisance problems, such as mosquitoes.

Swale with grass mowed too short and causing sediment discharge



All of these impacts may be avoided through proper and timely maintenance of stormwater management devices. The bottom line relating to implementation of stormwater management devices is that maintenance has to be assured or the device should not be built in the first place. The most common cause of stormwater management device failure is lack of maintenance.

Good design and construction can reduce subsequent maintenance needs and costs but they cannot eliminate the need for maintenance. Maintenance will always be needed and will require a long-term commitment of resources and personnel to ensure it is undertaken. Stormwater management devices are effective at contaminant capture and this will necessitate maintenance to ensure continued function.

18.2 Inspection and maintenance

There are two key elements to ensuring that stormwater management devices are maintained:

- When devices are to be inspected, and
- When maintenance needs to be accomplished.

Both of these items are discussed in more detail to provide guidance.

Stormwater pond with significant scour on side slopes



18.2.1 Device inspection frequencies

Stormwater management devices need to be inspected on a routine basis to ensure that they are functioning adequately. The inspection needs to consider all of the device components, as they all are integral to performance.

In terms of sensitivity of the individual devices to impaired performance the following discussion of each device provides a brief discussion of the principal reasons why performance deteriorates.

18.2.1.1 Swales and filter strips

Swales and filter strips are susceptible to impaired performance primarily as a result of excess sediment loadings smothering vegetation. Oils and greases can also be a serious concern as their entry could kill vegetation. These impacts can occur very quickly if large amounts of these contaminants are introduced in a short time frame.

Another common cause of poor performance is the existence of concentrated flow in them. Their optimum performance depends on the maintenance of distributed flow. Concentrated flow will be ineffective at contaminant removal and could also cause erosion, which is contrary to their purpose.

A recommended maintenance schedule for swales and filter strips is provided below:

Table 18-1: Recommended maintenance schedule for swales and filter strips¹⁷¹

Timing	Component	Action
Following storms	Inflow points	<ul style="list-style-type: none"> Check for scouring, channelling and erosion, and repair as necessary
	Side slopes	<ul style="list-style-type: none"> Check for scouring, channelling and erosion, and repair by adding soil and replanting as necessary
	Channel base	<ul style="list-style-type: none"> Check for scouring, channelling and erosion, and repair by adding soil and replanting as necessary
	Plants and soil	<ul style="list-style-type: none"> Check stormwater is filtering through soil following storm runoff Remove weeds
Monthly	Outlet	<ul style="list-style-type: none"> Check outlet for scouring or erosion and repair to suit
	Inflow points	<ul style="list-style-type: none"> Remove rubbish and debris
	Channel base	<ul style="list-style-type: none"> If grassed, mow channel no shorter than 150mm length Use catcher and remove clippings Re-seed bare patches of grass and water in dry conditions to establish
	Plants and soil	<ul style="list-style-type: none"> Replant gaps and water new plants in dry conditions until established
Two yearly	Outlet	<ul style="list-style-type: none"> Remove rubbish and debris from outlet grate or catchpit
	Channel base	<ul style="list-style-type: none"> Check for boggy patches and ponding water Check soil is not compacted, and aerate surface or tip up dips to repair
	Grass, plants and soil	<ul style="list-style-type: none"> Remove weeds, rubbish and debris Re-plant gaps and re-seed bare patches, and water if required to establish Aerate soil to prevent natural compaction, similar to coring sports fields and lawn bowls greens Check stormwater is filtering through soil, by either monitoring after storm runoff or by running water across swale

¹⁷¹ Auckland Council Swales & Filter Strips Operation & Maintenance Guide

Concentrated flow in a swale causing erosion



18.2.1.2 Sand filters

Sand filters are very sensitive to excessive loadings of oil and grease, which can clog their surface. Sediments can also be a problem, especially New Zealand’s fine-grained sediments in the silt/clay category. Coarser sediments do not cause a significant reduction in permeability although they do fill the forebay of sand filters and may cause premature bypass by clogging inlet points.

Sand filter clogged by oil and grease



A recommended maintenance schedule for sand filters is provided below:

IMPORTANT - Only people fully certified for confined space entry can enter sand filter chambers

Table 18-2: Recommended maintenance schedule for sand filters¹⁷²

Timing	Component	Action
Following storms	Inlet weir (if present)	<ul style="list-style-type: none"> Check weir is not blocked with debris – clear if necessary.
	Sediment chamber	<ul style="list-style-type: none"> Use hatch to check for floatables, and remove by hand or using sucker truck. Check sediment level. If depth is over half height of weir (or more than 200mm) then remove using sucker truck.
	Filter bed	<ul style="list-style-type: none"> Clear surface of rubbish and leaf litter.

¹⁷² Auckland Council Sand Filters Operation & Maintenance Guide

Timing	Component	Action
		<ul style="list-style-type: none"> • Check filter material has not been eroded. If level is below weir, top up with fresh filter material (do not compact). • Check filter is not clogged – see trouble shooting below.
	Underdrain	<ul style="list-style-type: none"> • Check underdrain for blockage using inspection well (if installed) or CCTV camera via outlet pipe. If blocked, see troubleshooting, below.
	Weir and spreader (if included)	<ul style="list-style-type: none"> • Remove any debris
	Inlet and outlet pipes	<ul style="list-style-type: none"> • Check for debris and clear if necessary
3 monthly	Inlet weir (if present)	<ul style="list-style-type: none"> • Check weir is not blocked with debris – clear if necessary.
	Sediment chamber	<ul style="list-style-type: none"> • Use hatch to check for floatables, and remove by hand or using sucker truck.
	Weir	<ul style="list-style-type: none"> • Remove any debris
6 monthly	Sediment chamber	<ul style="list-style-type: none"> • Check sediment level in chamber. If built up to more than half the height of weir between chambers (or over 200mm), then remove using sucker truck).
	Filter bed	<ul style="list-style-type: none"> • Clear surface of rubbish and leaf litter. • Check surface for algae and weed growth. Do not spray – remove manually. Rake and shovel top surface of algae or use sucker truck if possible and top up filter material (do not compact). • Check filter material has not been eroded. If level is below weir, top up to level of weir with fresh filter material (do not compact). • Check filter material is not clogged – see troubleshooting below.
	Underdrain	<ul style="list-style-type: none"> • Check underdrain for blockage using inspection well (if installed) or CCTV camera via outlet pipe. If blocked, see troubleshooting, below.
	Inlet and outlet pipes	<ul style="list-style-type: none"> • Check for erosion at outlet. Replace or repair damaged erosion protection (rip-rap or geotextile) and repair erosion.
Annually	Inlet and outlet pipes	<ul style="list-style-type: none"> • Inspect for blockages – clear pipes using sucker truck if necessary. Debris to be removed off-site, not disposed of through filter or downstream.
	Hinges, lids and covers	<ul style="list-style-type: none"> • Check all in working order. Oil hinges and remove rust. Check covers can be lifted and placed back easily. • Remove any debris.
Two yearly	Drain down	<ul style="list-style-type: none"> • Undertake during dry weather, and when sand is due to be replaced or other clean out is required. • Block off incoming and outgoing pipes to filter. • Pump out sedimentation chamber. • Use drain down valve (if present) to drain sand filter material. If no valve, remove as much ponded water as possible from surface.

Timing	Component	Action
	Remove filter material	<ul style="list-style-type: none"> Carefully remove filter material avoiding damage to underdrain. Use sucker truck – material may also need to be loosened with shovel. If necessary clear outlet and other components. Geotextile around underdrain may need to be removed for inspection.
	Inspection	<ul style="list-style-type: none"> Check inside of filter base, walls, weirs, spreader, baffles for cracking or damage. Minor hairline cracks may be repaired and reported to owner of sand filter. More extensive damage may indicate unstable foundations. Report damage as soon as possible so structural inspection by engineer can be arranged. Once inspection and repairs complete, reinstate sand filter and unblock inlet and outlet.

WARNING CONTAMINATED SOIL - Sand filters treat stormwater runoff from roads, car parks, driveways and other hard surfaces, collecting pollutants. Sand filter material will accumulate these pollutants, contaminating the mix. Material removed from these devices **MUST** be disposed of at an approved landfill.

Table 18-3: Troubleshooting for sand filters¹⁷³

Symptom	Possible problems	Solution
Underdrain not flowing	Underdrain blocked	<ul style="list-style-type: none"> Use CCTV via outlet manhole or inspection well to check for blockage or damage to underdrain. Use low pressure hose to gently backwash underdrain.
	Perforations in underdrain or geotextile clogged	<ul style="list-style-type: none"> Use low pressure hose to gently backwash underdrain perforations and geotextile.
	Blocked diversion weir	<ul style="list-style-type: none"> Remove rubbish, leaves and other debris
	Debris blocking inlet pipe	<ul style="list-style-type: none"> Clear debris
	Filter blocked	<ul style="list-style-type: none"> See above
	Underdrain damaged	<ul style="list-style-type: none"> Refer to engineer for structural inspection.
Inlet submerged (water level in filter is higher than usual)	Overflow system may be blocked	<ul style="list-style-type: none"> Clear overflow system of debris
Sulphur smell	Organic material decomposing in filter material, or algae present on surface of filter bed	<ul style="list-style-type: none"> Rake and remove surface debris from filter bed. If algae present, rake or till top 50mm of material. If smell persists, remove and replace top 50mm of filter material. If smell still present, the filter bed may need full replacement.
Erosion of filter bed	Flow splitter is blocked creating unequal flow across filter	Clear flow splitter of debris
	Filter surface is no longer at level of the weir	Top up fresh material and level off – do not compact

¹⁷³ Auckland Council Sand Filters Operation and Maintenance Guide

	between sediment and filter chamber	
	Part of underdrain blocked causing uneven drainage	See underdrain blockage, above.
	Filter bed no level causing uneven flow across surface	Top up with fresh material and level off – do not compact.

18.2.1.3 Bioretention devices

Bioretention devices are very sensitive to excessive loadings of oil and grease, which can clog their surface. Sediments can also be a problem, especially New Zealand’s fine-grained sediments in the silt/clay category. Coarser sediments do not cause a significant reduction in permeability although they may cause premature bypass of bioretention devices by clogging inlet points.

A recommended maintenance schedule for bioretention devices is provided below:

Table 18-4: Recommended maintenance schedule for bioretention devices¹⁷⁴

Timing	Component	Action
Following storms	Grass filter strip (if included), kerbing, paved area	<ul style="list-style-type: none"> Remove rubbish, leaves and other debris from the grass filter strip and surrounding drainage area
	Ponding area	<ul style="list-style-type: none"> Clear inflow points of sediments, rubbish and leaves. Check for erosion or gouging and repair. Test drainage of ponding area – check garden 24 hours after rain to ensure no water is ponding. Top up soil and mulch as necessary (ensuring level is below surrounding hard surface and overflow)
	Mulch	<ul style="list-style-type: none"> Mulch may need to be redistributed or added around inflow points.
3 monthly	Grass filter strip, kerbing, paved area	<ul style="list-style-type: none"> If grass strip is present, mowing frequency depends on growth rates and seasons. Mow no shorter than 50mm (approximately 3 finger widths). Do not mow grass shorter or the filter strip will not work properly Re-sow grass as necessary. Remove rubbish, leaves and other debris. Check soil and mulch level is below surrounding hard surface areas and overflow. Remove excess mulch/soil if required.
	Ponding area	<ul style="list-style-type: none"> Clear inflow points of built up sediment, rubbish and leaves. Check for erosion or gouging – repair if necessary.
	Mulch layer (bark, pebbles, etc.)	<ul style="list-style-type: none"> Remove rubbish, leaves and other debris. After storm events, mulch may need to be redistributed or added around inflow points.
	Plants	<ul style="list-style-type: none"> Water establishing plants monthly during extended dry periods. Check plant health and replace dead plants as necessary. Use native species to suit garden conditions (eg. full sun or shaded).

¹⁷⁴ Auckland Council Rain Gardens Operation & Maintenance Guide

Timing	Component	Action
		<ul style="list-style-type: none"> Remove weeds – do not use herbicides, pesticides and fertilisers as these chemicals will pollute the stormwater runoff.
Annually	Ponding area	<ul style="list-style-type: none"> Clear inflow points of sediment, rubbish and leaves. Check for erosion or gouging and repair. Check all water has drained 24 hours after heavy rain. Alternatively test drainage of ponding area. Dig a hole 200mm wide x 200mm deep. Pour in 10 litres of water in hole. Check drainage rate over 1 hour period – minimum 25mm/hour. If crust of fine sediment present on surface of soil mix, remove with spade and rework using rake. Top up soil and mulch as necessary (ensuring level is below surrounding hard surface and overflow). Dispose of contaminated crusted topsoil in a secure landfill (unless soil testing shows no contamination).
	Rain garden soil mix	<ul style="list-style-type: none"> Check soil level is below surrounding hard surface level and overflow grate. Use drainage test described above to check soil is free draining.
	Mulch layer (bark, pebbles, etc.)	<ul style="list-style-type: none"> Check surface of mulch for build-up of sediment, remove and replace as required.
	Underdrain system	<ul style="list-style-type: none"> Use inspection well (if present) to check underdrain is working properly. Check rain garden draining freely using the drainage test described above. If rain garden is not free-draining, the underdrain may be blocked. Try back-washing under drain from the outlet. If still blocked, the rain garden may need plants and rain garden soil mix removed and replaced.

Table 18-5: Troubleshooting for bioretention devices¹⁷⁵

Symptom	Possible problems	Solution
Stormwater runoff is bypassing the rain garden	Local earthworks increasing sediment load to rain garden, blocking rain garden outlets or raising surface level of the rain garden	<ul style="list-style-type: none"> Check surface of the rain garden is below the surrounding areas. Remove any sediments and debris from inflow areas and from the surface of the rain garden. Protect rain garden from future construction sediments.
	Rubbish and other debris blocking the inflow points to the rain garden	<ul style="list-style-type: none"> Regularly remove rubbish, leaves and any other debris from inflow points.
Rain garden is ponding for longer than 24 hours	Incorrect blend of soil mix	<ul style="list-style-type: none"> Replace soil mix with the correct rain garden soil mix. Do Ribbon test or Percolation test to test soil mix is free-draining.

¹⁷⁵ Auckland Council Rain Garden Operation and Maintenance Guide

Symptom	Possible problems	Solution
Stormwater and/or mulch flowing off the rain garden	The soil within the garden compacted during construction or other activities.	<ul style="list-style-type: none"> Loosen the top 500mm of soil by tilling or forking. Discourage vehicle, pedestrian and bicycle access to the rain garden.
	Layer of fine sediment settled on the garden surface	<ul style="list-style-type: none"> Remove fine sediment layer and turn over the top layer of rain garden soil mix. Protect rain garden from surrounding sediment run off.
	Rain garden filled with too much mulch or soil	<ul style="list-style-type: none"> Remove excess mulch or soil so that surface of ponding area is approximately 200-300mm below the surrounding hard surfaces and overflow.
	Overflows or discharge pipes clogged with sediments or debris	<ul style="list-style-type: none"> Clear overflow and discharge pipes.
	Planting or rain garden soil mix clogged	<ul style="list-style-type: none"> It may be necessary to remove some of the rain garden soil mix and replace with fresh rain garden soil mix.
Sulphur smell coming from the rain garden	Plants and soils lacking oxygen (anaerobic conditions). Organic material rotting within the garden	<ul style="list-style-type: none"> Inspect rain garden after rain event to check garden drains within 12 – 24 hours (see solutions above for rain garden ponding)
	The underdrain clogged and water is not properly draining out of the garden	
Erosion and gouging occurring within the rain garden	Kerbs and other hard structures channelling stormwater flow (rain gardens require an event sheet of flow of water to operate effectively)	<ul style="list-style-type: none"> Create openings in the kerb to increase number and width of run off points, or replace kerbing with a different design (eg. kerbing slightly raised off the ground)
	Inflow points are too concentrated	<ul style="list-style-type: none"> Increase kerb opening size by cutting kerbs or replacing with different design. If this is not possible install rip-rap (i.e. stones set into concrete) at the inflow point to spread flow and reduce erosion.
Plants are stressed or dying. Symptoms may include yellowing of leaves, unseasonal leaf fall, wilting.	Plant varieties selected for rain garden are unsuitable for the location and/or extreme wet/dry conditions.	<ul style="list-style-type: none"> Select plants appropriate for the location (eg. full shade, partial shade, full sun, etc.) Due to their hardy nature, native plants are recommended.
	Ponding or excessively long periods of flooding cause plants to become stressed or die.	<ul style="list-style-type: none"> Inspect rain garden after rain event to check garden drains within 12 – 24 hour. If not, see above solutions for rain garden ponding.
	The plants poisoned by runoff from a hazards spill (fuel, paint, oil, etc).	<ul style="list-style-type: none"> Check soil and mulch for evidence of heavily polluted runoff (eg. rainbow slick, coloured mulch, etc.)
	Pollutants accumulated in the rain garden reached a toxic level for plants.	<ul style="list-style-type: none"> If contamination is extensive, clean out raingarden soil mix and replace fresh soil and new plants.
	The plants dehydrated from extended dry conditions	<ul style="list-style-type: none"> Newly established plants need watering. Check soil moisture content and water plants if dry.

Symptom	Possible problems	Solution
		<ul style="list-style-type: none"> Establishing plants need watering in dry weather.
	Plants stressed due to attack by plant pests or diseases. Pests may include insects or animals.	<ul style="list-style-type: none"> Check for leaf damage or pests and consult gardening manuals or a garden centre for the best treatment. Stressed plants need replacing with healthy variety or pest-resistance species.
	Rain garden soil mix compacted	<ul style="list-style-type: none"> Loosen the top 500mm of soil by tilling or forking. Do not allow vehicle, pedestrian and bicycle access to the rain garden.

18.2.1.4 Infiltration devices

Infiltration devices are very sensitive to impaired performance if excessive amounts of sediments or oils and greases are introduced into them. The greatest problem is clogging of soils in the sides and bottom or in the case of permeable paving surface clogging. This can occur fairly rapidly if inflow sediment loads are not reduced by pre-treatment devices.

Other contaminants, which are attached to sediments, are not considered a clogging concern.

Another problem is poor drainage as a result of high water table, groundwater mounding or a confining soil layer. Prolonged wetness encourages micro-organism growths that tend to clog soils.

18.2.1.5 Ponds and wetlands

One of the greatest benefits of stormwater management ponds and wetlands is their resilient performance even when excessive contaminant loads enter them. However, performance will suffer if sediment is introduced in large amounts over a lengthy time frame. Sediments reduce the volume of storage and reduce extended detention times, which ultimately reduce the pond or wetland's contaminant reduction potential.

This impaired function is not something that tends to occur dramatically in a short time period but rather occurs cumulatively over a longer time period if the incoming sediment load is consistently elevated.

Another problem that ponds and wetlands have that other devices do not have to such an extent is maintenance problems associated with debris clogging inlets and outlet areas. While other devices can have visual issues related to debris, pond outlets can become blocked, especially the extended detention orifices. Clogging of these outfall orifices can cause significant adverse effects by elevating water in the pond or wetland and potentially killing the vegetation, increasing safety concerns and increasing the zone of saturation in the pond or wetland embankment.

Sediment forebay clogged with sediment and needing to be cleaned out



A recommended maintenance schedule for wetlands is provided below:

Table 18-6: Recommended maintenance schedule for wetlands¹⁷⁶

Timing	Component	Action
Following storms	Inlet	<ul style="list-style-type: none"> Inspect and remove rubbish and debris from inlets. Check area around inlet, especially energy dissipation (rip rap) structures for erosion and cracking, and if present, repair.
	Trash racks and debris screens (if fitted)	<ul style="list-style-type: none"> Inspect and clear all litter, including leaves, rubbish, branches and any other material that would block flows. Check racks for corrosion and replace if necessary.
	Sediment forebay	<ul style="list-style-type: none"> Check the forebay for accumulated sediment. In general the forebay should be dredged if sediment fills over 50% of the design volume. Test sediments for contaminants (eg. heavy metals, PAHs) prior to dredging and dispose of sediment to landfill or similar, suitable for contaminant levels.
Following storms	Bund	<ul style="list-style-type: none"> Check for erosion or instability and repair if required.
	Risers, control structures, grates, outlet pipes, skimmers, weirs and orifices	<ul style="list-style-type: none"> Inspect control structures, weirs, orifices, outfall pipes for leaks and blockages. Blockage could be sediment build up, floating debris, rubbish. Control structures could be overgrown with vegetation. Clear and remove all blockages to avoid local flooding. Areas around control structure need to be clear of vegetation and rubbish to maintain stormwater flow. A boat may be required to access the outlet. Inspect outflow pipes for leaky joints or soil piping erosion. Check if anti-seep collars need repair or replacement. Check outfall and water discharge areas for erosion and restore and stabilise erosion. Check energy dissipaters are adequate.
	Emergency overflow or spillway	<ul style="list-style-type: none"> Check emergency overflow path remains clear of debris and blockages and remove any blockages. Check flow path for erosion and repair as necessary. Structural repairs must be repaired immediately to avoid catastrophic failure.
	Erosion and bank stability	<ul style="list-style-type: none"> Inspect banks for settlement, erosion, scouring, cracking, sloughing, seepage and rilling.

¹⁷⁶ Auckland Council Wetlands Operation & Maintenance Guide

Timing	Component	Action
		<ul style="list-style-type: none"> Remove woody vegetation growth (unless species specifically included in pond planting plans) to avoid future root damage to banks. Removal will require bank material replacement and repair, compacted to design specification of maximum 90% dry soil density. Inspect for pedestrian and cycle traffic or pathways on banks. Either restrict traffic by closing paths off or provide suitable resistant ground cover to avoid erosion from traffic.
	Water body	<ul style="list-style-type: none"> Remove rubbish and other floating debris from wetland pond. Inspect for algal blooms (usually dense water discolouration or surface scum) or fish kills – these could indicate water has extremely low levels of oxygen (eutrophication), or high nutrient loads or pollutants. Test water quality if these problems are suspected.
Following storms	Wildlife	<ul style="list-style-type: none"> Control pest species so they do not threaten birds and aquatic life of the wetland. Remove dead animals, especially water birds, to prevent disease spread. Wet areas where mosquito (mosquito larvae) could breed need careful maintenance.
	Soil	<ul style="list-style-type: none"> Inspect for loss of soil on wetland banks from erosion. If plants are struggling to grow soil fertilizer may be required, but extra care must be taken to prevent fertilizer from entering wetland and local waterways.
Monthly	Inlet	<ul style="list-style-type: none"> Inspect and removal rubbish and debris from inlets.
	Trash racks and debris screens (if fitted)	<ul style="list-style-type: none"> Inspect and clear all litter, including leaves, rubbish, branches and any other material that would block flows. Check racks for corrosion and replace if necessary.
	Risers, control structures, grates, outlet pipes, skimmers, weirs and orifices	<ul style="list-style-type: none"> Inspect control structures, weirs, orifices, outfall pipes for leaks and blockages. Blockage could be sediment build up, floating debris, rubbish. Control structures could be overgrown with vegetation. Clear and remove all blockages to avoid local flooding. Areas around control structure need to be clear of vegetation and rubbish to maintain stormwater flow. Boat may be required to access outlet.

Timing	Component	Action
	Emergency overflow or spillway	<ul style="list-style-type: none"> • Check emergency overflow path remains clear of debris and blockages and remove any blockages. • Check flow path for erosion and repair as necessary. Structural repairs must be repaired immediately to avoid catastrophic failure.
	Erosion and bank stability	<ul style="list-style-type: none"> • Inspect banks for settlement, erosion, scouring, cracking, sloughing, seepage and rilling. • Remove woody vegetation growth (unless species specifically included in pond planting plans) to avoid future root damage to banks. Removal will require bank material replacement and repair, compacted to design specification of maximum 90% dry soil density. • Inspect for pedestrian and cycle traffic or pathways on banks. • Either restrict traffic by closing paths off or provide suitable resistant ground cover to avoid erosion from traffic.
Monthly	Landscaping	<ul style="list-style-type: none"> • Clear wetland plants or weeds and prune and replace three-monthly. Mow split grass around pond monthly. Schedules may vary depending on seasonal growth.
	Water body	<ul style="list-style-type: none"> • Remove rubbish and other floating debris from wetland pond. • Inspect for algal blooms (usually dense water discolouration or surface scum) or fish kills – these could indicate water has extremely low levels of oxygen (eutrophication), or high nutrient loads or pollutants. • Test water quality if these problems are suspected.
	Wildlife	<ul style="list-style-type: none"> • Control pest species so they do not threaten birds and aquatic life of the wetland. • Remove dead animals, especially water birds, to prevent disease spread. Wet areas where mosquito (mosquito larvae) could breed need careful maintenance.
	Soil	<ul style="list-style-type: none"> • Inspect for loss of soil on wetland banks from erosion. If plants are struggling to grow soil fertilizer may be required, but extra care must be taken to prevent fertilizer from entering wetland and local waterways.
6 monthly	Inlet	<ul style="list-style-type: none"> • Check area around inlet, especially energy dissipation (rip rap) structures for erosion and cracking, and if present, repair.

Timing	Component	Action
	Bund	<ul style="list-style-type: none"> Check for erosion or instability and repair if required.
	Risers, control structures, grates, outlet pipes, skimmers, weirs and orifices	<ul style="list-style-type: none"> Inspect outflow pipes for leaky joints or soil piping erosion. Check if anti-seep collars need repair or replacement. Check outfall and water discharge areas for erosion and restore and stabilise erosion. Check energy dissipaters are adequate.
	Littoral zones	<ul style="list-style-type: none"> Inspect wetland plants for exotic or invasive/nuisance water species and remove. Control may be done manually, or with appropriate herbicide by properly licensed and registered professionals. Follow up inspections may be needed during growing season.
Annually	Valves and pumps	<ul style="list-style-type: none"> Check pumps and valves, if present, are functioning properly. Check moving parts for corrosion and lubricate if required.
2+ years	Wetland liners	<ul style="list-style-type: none"> Inspect liner for leaks and fix as per manufacturer's or design specifications.
	Sediment forebay	<ul style="list-style-type: none"> Check the forebay for accumulated sediment. In general the forebay should be dredged if sediment fills over 50% of design volume. Test sediment for contaminants (eg. heavy metals, PAHs) prior to dredging and dispose of sediment to landfill or similar suitable for contaminant levels.

Table 18-7: Trouble shooting for wetland¹⁷⁷

Symptom	Possible problems	Solution
Wetland water levels remain high	The outlet riser openings may be too narrow to allow fast draining after a storm	<ul style="list-style-type: none"> Unless water levels remain high for more than two days or flooding is a threat, action may not be necessary. Refer decision to supervisor if necessary.
	Outlet structures are clogged	<ul style="list-style-type: none"> Check outlet structures and openings for blockage by debris or sediment, and clean as necessary.
Wetland is dry	Invasive plants (such as raupo) clogging pond area	<ul style="list-style-type: none"> Remove plants by hand, do not use herbicide.
	A maintenance valve is open	<ul style="list-style-type: none"> Check drain valves and shut if open
	Water leaking from cracks in outlet structure	<ul style="list-style-type: none"> Inspect for cracks and repair as necessary Inspect for leaky joints at outlet pipes and repair

¹⁷⁷ Auckland Council Wetlands Operation and Maintenance Guide

Symptom	Possible problems	Solution
	Wetland in area of changing groundwater levels	<ul style="list-style-type: none"> • Pond will remain dry as long as groundwater levels are low. • Design for pond should have taken this into account, so this may be normal for this wetland.
	Groundwater levels have dropped due to drought conditions	<ul style="list-style-type: none"> • Drought conditions cannot be solved, until wet season restores wetland pond levels. Use drought opportunity to clean sediments from forebay and repair stormwater infrastructure.
Stormwater discharging from the wetland looks dirty, muddy or dark	High concentration of sediments washing into wetland, especially silts and clays, due to erosion or construction in the catchment area	<ul style="list-style-type: none"> • Check catchment for erosion areas, including construction works. • Check erosion controls are in place. Add or repair erosion control as required
	Forebay full of sediment	<ul style="list-style-type: none"> • Forebay usually needs more frequent clearing of sediment than wetland pond. Dredging required when forebay water storage is around 50% of total volume.
	Local works disturbing soils, with rain washing these into wetland	<ul style="list-style-type: none"> • Check erosion and sediment controls in place on local construction sites • Repair if necessary and stabilise areas of exposed soil where erosion occurring
	Wetland outlet constructed too close to inlet, preventing treatment of water before discharge	<ul style="list-style-type: none"> • Should have been designed to suit. Well placed baffles or islands in wetland may redirect and slow flows to increase treatment between inlet and outlet points.
Wetland plants are growing over the edges and across surface of the pond	Wetland plants are growing in shallow edges of pond	<ul style="list-style-type: none"> • Constructed wetlands are designed to have plants growing large fringes across pond. No action required unless plants are affecting pond function, for instance, clogging outlet structure.
Pond banks are eroding	Water flowing down pond banks is eroding soils	<ul style="list-style-type: none"> • Minor erosion can be repaired by replacing soil and stabilising with planting or other methods
	Stormwater outlet pipes direct flow at banks	<ul style="list-style-type: none"> • Cause of erosion from direct discharge may be repaired, for instance, by extending pipes down into pond. • Extensive erosion due to continuing discharge may require erosion protection such as rip-rap, geotextile.
Water is leaking from the wetland and through the banks along pipes	Leak collars around pipes have failed or have not been fitted correctly (or at all). This can lead to failure of banks.	<ul style="list-style-type: none"> • Failure of pond banks can cause major damage at pond and downstream, so qualified construction contractors should make immediate repairs. This usually requires pond to be drained, banks excavated, leak collars repaired, and pond banks

Symptom	Possible problems	Solution
		reconstructed to original design specifications.
Dead or dying birds	Botulism is a common killer of pond birds. Birds ingest toxins produced by the bacteria <i>Clostridium botulinum</i> , either from the water or by eating maggots or other infected food sources. Botulism can occur when water levels are low, often mid to late summer when pond water stagnates. It can also appear after algal blooms, when water oxygen levels are low.	<ul style="list-style-type: none"> Remove all dead birds and animals from the area to reduce the spread of Botulism. Avoid algal blooms (see below). Maintain flows through the ponds to avoid stagnant water. Improve shading over the water.
Algal blooms (yellow, green, red or blue-green coloured scum on the surface of the water)	Algae is naturally present in waterways. Algal blooms occur in good growing conditions, including stagnant or slow moving water, high levels of nutrients, and warm and sunny weather	<ul style="list-style-type: none"> Avoid blooms by reducing nutrients entering the wetland, (for instance, controlling fertilizers from the surrounding area) and by maintaining water flows. Although there are a number of suggested ways to deal with blooms, few are proven to work. The use of barley straw bales in the pond may work in some cases.
Animal pests present	Dense plant cover and abundant food supply in wetlands supports many animals, including pest species	<ul style="list-style-type: none"> Thin out vegetation where possible. Set traps and poison in the area, using recommended procedures such as careful poison placement and providing warning signs.
Plants on edge of pond dying	Plants are suffering extreme wet and dry conditions.	<ul style="list-style-type: none"> Choose plant varieties suitable to local conditions. New plants need watering until established. Replace unsuitable varieties.

18.2.1.6 Green roofs

Principal reasons why this device performance can deteriorate are the following:

- Impermeable membrane failure due to leakage, puncture or UV deterioration
- Excessive weed growth outcompeting planted growth
- Ponding of water on flat roofs
- Concentration of flows across the green roof causing scour and discharge at locations not designed for
- Clogging of substrate, and
- Plugged outlets.

18.2.1.7 Water tanks

Water tank function can be compromised mainly due to two reasons:

1. Inadequate water supply where demand exceeds supply, and
2. The tank outlets or downspouts become clogged due to excessive vegetative entry into the tank from roof spouting.

The issue where demand exceeds supply is generally an issue during summer months and usage should be monitored during this period. Clogging of tank outlets or downspouts can be reduced if filtering systems are placed in the gutters to prevent discharge of leafy material into the system.

18.2.1.8 Bush revegetation

Long term establishment and propagation of plants is mainly a concern over the first 5 10 years but within that timeframe there can be a concern due to predation by possums or rabbits. They can eat new plants and attack leafy growth on established plants.

18.2.1.9 Oil/water separator

As oil/water separators are a prefabricated unit. Their primary function is to provide conditions where oil separates from water and rises to the water surface in the separator, thus preventing its discharge from the separator. The major maintenance issues include excessive build-up of sludge at the bottom of the separator or the oil on the surface of the water becoming so deep that it mixes with incoming water, becomes emulsified and discharges.

18.2.2 Timing of device maintenance

The discussion of when a device needs to be maintained depends somewhat on what is used as a baseline. This needs to be undertaken at several different levels depending on the device that is being used for water quality treatment. The levels will depend on two primary factors:

- Physical function
- Water quality analyses.

It is not possible to establish specific times when maintenance needs to be undertaken, as those times will be different for each site. The frequency of maintenance depends on the contaminant load entering the device and contaminant loads will vary depending on land use. Higher loads would necessitate more frequent maintenance.

The ability of a stormwater management device to remain effective at contaminant reduction depends on both factors being assessed.

Extended detention outlet clogged and in need of maintenance



If physical functions are impaired then bypass will occur on a more frequent basis or short-circuiting may result. Assessing water quality performance will provide information on when a stormwater management device has performance reduction resulting from adsorption capability being exceeded or biological functions being impaired. This may not necessarily be reflected in physical function reduction. In other words, permeability rates may still be relatively high but dissolved zinc or copper may pass through the system and be released off-site. The following discussions relate to both situations.

18.2.2.1 Physical function processes

Physical function processes rely on those treatment processes detailed in Section 6 to provide water quality treatment. As long as those processes are still functioning, the device should remove contaminants. If those processes are limited due to clogging, poor vegetation growth or general lack of maintenance then the device needs to be maintained.

Table 18-8 provides information on when maintenance needs to be undertaken based on physical function. Whenever water quality monitoring is undertaken, the physical parameters should also be assessed at the same time.

Table 18-8: Physical function impairment criteria

Device/practice	Original parameters*	Physical function Impaired	Means to determine impairment
Swale and filter strip	Dense, uniform vegetation throughout swale or filter strip 9 minute residence time Vegetation length of at least 50 mm or height used in design (100 mm preferred)	Evidence of concentrated flow Vegetation becomes sparse or overgrown or undesired vegetation overgrows area Obvious sediment or debris accumulation	Visual
Sand filter	Design permeability of at least 1 metre per day	Permeability rate drops below 300 mm/day Evidence of flow bypass**	Permeability testing
Rain garden	Design permeability of at least 300 mm per day	Permeability rate drops below 100 mm/day Evidence of flow bypass**	Permeability testing Visual
Infiltration practice	Design permeability of at least 7 mm per hour but less than 1 metre per hour	Permeability rate drops below 1 mm per hour Evidence of flow bypass**	Permeability testing Visual
Pond	Sediment forebay sized for at least 15% of the water quality volume	Sediment forebay filled to approximately 50% of its design volume. Main pond when sediment deposition is within 400 mm of the pond water surface (if wetland vegetation has not been established)	Visual or using a measuring rod
Wetland	Sediment forebay at least 15% of the water quality volume	Sediment forebay filled to approximately 50% of its design volume If main wetland area has evidence of flow short-circuiting or obvious evidence of sediment smothering plants	Visual or using a measuring rod
Green roof	150 mm depth of media substrate Waterproof membrane per design requirements Plant establishment	Leakage of waterproof membrane. Erosion of media substrate Plant mortality Drainage system not functioning as designed	Visual
Water tank	5 or 10 day (depending on use) inter-event dry period along with daily use available for storage. Detention storage provided	Storage volume reduced due to debris entering tank such that 200 mm of bottom volume is displaced and debris starts to clog the outlet orifices.	Visual
Revegetation	Weed suppression when planting is done Successful establishment of plants per design recommendations	Predation by pest species Weed overgrowth stunting or killing planted vegetation	Visual
Oil and water separator	Initial specifications of installed unit	Oil layer exceeds 3 mm depth Sludge removal when the thickness exceeds 150 mm Evidence of flow bypass**	Visual

* These values are provided for the values contained in this guideline. If a local consent has requirements at variance to those in the Standard, the consent requirements must take preference.

** Evidence of flow bypass is expected to occur when rainfall depths exceed the water quality storm (90%) over a 24-hour period for a given location.

As can be seen from the sand filter, rain garden and infiltration devices a good barometer of performance would be actual permeability testing. In this situation, the site inspection equipment should include an auger, a hollow pipe and several litres of water. Performance of those devices cannot be determined through visual inspection during dry weather. Information gathered visually is indicative only.

18.2.2.2 Chemical function processes

Considering chemical function means taking and evaluating water quality samples to determine or verify performance of stormwater management devices.

There may be situations where chemical monitoring is to be pursued due to a consent requirement, particularly on an industrial consent. This might be where there is a need to determine when the stormwater device has provided all of the storage that it can for a given contaminant and maintenance needs to be undertaken. If meeting effluent limits is a consent requirement it is assumed that taking grab samples rather than the use of continuous sampling will be the method of sampling.

Grab sampling is low cost and tends not to be very representative because of the temporal and spatial variability usually associated with urban water resources and stormwater runoff. As such the results obtained cannot be considered terribly accurate and should be used from a relative context rather than as an absolute measure of performance. Regardless, the information obtained from this type of approach can provide good information for device maintenance frequency.

The water quality monitoring should also include a visual examination of the stormwater discharge. Visual examinations provide a simple and inexpensive means of obtaining a rough assessment of stormwater quality. The visual examination is of the stormwater sample collected to note the following:

- Any colour
- Odour
- Clarity
- Floating solids
- Settled solids
- Suspended solids
- Foam
- Oil sheen, and
- Any other indicators of possible stormwater pollution.

This approach to monitoring is to assess performance of stormwater treatment devices. If there are more than two devices on a given site, the consent holder may consider monitoring only one device discharge if it is believed that the discharges from the different devices would have substantially identical effluents.

Monitoring should be undertaken twice a year for up to three years to provide data on performance to determine maintenance intervals. Once a maintenance frequency is determined by the monitoring, the monitoring can be reduced or eliminated until a change in site condition or a consent requirement would require otherwise.

Key points include the following items:

- Grab samples are the common method for sample collection

- Storm sampled should be greater than 5 mm of rainfall
- An inter-event dry period of at least 72 hours before monitoring
- Two samples should be collected: the first within 30 minutes of discharge commencement, and the second one approximately 60 minutes after discharge commencement, and
- Visually examine the sample.

Monitoring protocols shall be approved by Waikato Regional Council prior to initiation.

18.2.2.3 Summary of maintenance criteria

In terms of when device maintenance needs to be performed, there are two measures that determine when maintenance needs to be undertaken:

1. Maintenance needs to be undertaken when physical functions are impaired.

This is an obvious requirement. Regardless of the water quality issues, impairment will cause a device to bypass, which will prevent proper water quality function. The parameters detailed in Table 18-8 provide criteria for when stormwater management device maintenance needs to be undertaken.

2. Water quality issues

This measure can be considered from two different contexts:

- a) The discharge violates a consent condition or a water quality standard referred to in a consent such as the ANZECC Guidelines

This is a difficult criterion to consider for a number of reasons:

- Having to relate the discharge to downstream effects
- Concentrations will be related to the size of the storm. A larger storm will have lower event mean contaminant concentrations than a smaller one.
- Grab samples can only be indicative at best. To attempt to use the results of two grab samples (reference and subsequent) for an indication of maintenance need would be difficult and longer-term monitoring would provide better, more accurate results.

It is important to understand the complexities of undertaking monitoring by using effluent standards. While mentioning the difficulties of going with an effluent limits approach, the U.S. EPA uses that approach for monitoring compliance with National Pollutant Discharge Elimination Standards (NPDES). The problems mentioned above exist in the U.S. but they have gone down this track, which was founded in point source industrial discharges over 30 years ago. They took that well-founded approach and have adapted it to stormwater discharges even though there are difficulties with that.

- b) The quality of the discharge is significantly at variance to grab samples taken shortly after a given device is completed.

The rationale behind this approach is to determine when various parameters indicate that the ability of a device to capture contaminant loads has been reduced.

The following recommendations are made for use in implementation.

1. The monitoring programme would identify the contaminants of greatest concern for the site, the functional impairment issues and how testing of contaminant and function will be done.
2. Two initial grab samples are taken according to when it is suitable to take the samples as per what is outlined in Table 18-9.

Table 18-9: Initial monitoring timeframes for stormwater devices

Device or practice	Initial monitoring and recommendation
Swale and filter strip	3 months after construction
Sand filter	1 month after completion
Rain garden	2 months after completion and site stabilisation
Infiltration device	1 month after completion
Pond	90% pond perimeter stabilised
Wetland	1 year after construction
Green roof	No monitoring necessary
Water tank	No monitoring necessary
Revegetation	No monitoring necessary
Oil and water separator	Immediately

3. Subsequent sampling and the storm rainfall information should be taken approximately 6 months apart to provide an indication of device performance. Being taken twice a year, the sampling would provide an indication of declining performance or whether a threshold has been passed that would indicate maintenance needs.
4. Physical function impairment should also be assessed at the same time that grab samples are taken.
5. The water quality monitoring is to determine if maintenance is needed. If at any time, metals or sediment results are more than a magnitude greater than the reference condition, maintenance needs to be accomplished. The results indicate a need for maintenance and the monitoring time frame assists in determining when future maintenance may need to be accomplished.
6. If physical function is significantly impaired (as per Table 18-8) and by-pass may occur, the maintenance contractor has to be notified and provided with a time frame for when maintenance needs to be accomplished.
7. Results of the functional basis analyses and water quality sampling shall be documented. That documentation shall include the following:
 - Results of functional basis analyses
 - Water quality monitoring results
 - Any maintenance activities undertaken during the time
 - Recommendations for maintenance for subsequent years.

Where there is an existing land use having an existing water quality standard as a consent requirement, it will not be possible to have initial monitoring results to use as a barometer for establishing subsequent maintenance frequency. How to address those situations will depend on a number of issues including:

1. Whether there is an existing consent for the site
2. Whether the existing consent requires water quality monitoring and for what purpose.
3. To what extent the stormwater management device treats contaminants of greatest concern.

The same issue exists for this situation as the new sites in the context of BPO versus water quality standards. If there is an existing consent, the consent has to be reviewed to assess the stormwater management device's appropriateness for the site, whether there are water quality

parameters and limits that have been imposed and what obligations the property owner has for maintenance.

These values do not relate to ANZECC guidelines or any other standard. In terms of other contaminants those values can be provided if desired. They are selected only as being representative values to determine that a stormwater management device performance is clearly impeded and maintenance needs to be accomplished. It is not recommended to go any further with recommendations due to the variability and inaccuracies associated with a grab sample approach. If greater accuracy were needed then a different, more comprehensive monitoring approach would have to be pursued. The advantage of the grab sample approach is that it is inexpensive, can be undertaken by any individual with some direction and can be used for making general recommendations for maintenance.

18.3 Documenting inspection and maintenance

Device tracking and recording of information are important components of the maintenance of stormwater management devices. It is important that site operators or owners track maintenance by use of a database. This would allow inspectors to know what devices need to be inspected when, when maintenance was last accomplished and when additional maintenance may be needed.

Raingarden with inappropriate traffic crossings



The data should include identification numbers for each device, the type of device and its location, special maintenance needs and data from previous inspections including any functional or chemical monitoring that is done. The approach would then identify maintenance timeframes.

This approach would assist in assuring that problems are corrected in the order of risk that they pose. It would ensure that no devices “fall through the cracks” in terms of inspection frequency and maintenance. Tracking of when a device was last inspected and the device’s status should never rely on the memory of any one individual.

18.4 Prioritising maintenance tasks

Maintenance can be broken down into three types and are listed in a declining order of priority:

- Corrective maintenance
- Preventive maintenance, and
- Aesthetic maintenance

18.4.1 Corrective maintenance

Corrective maintenance is a high priority whenever it is needed and is more important than preventive maintenance if a specific situation is being considered. In a similar regard, preventive maintenance should be a higher priority than aesthetic maintenance but all three forms of maintenance are needed. Depending on workload, especially where there is a potential safety concern, maintenance prioritisation should be based on the above order.

Those items normally considered as corrective maintenance include, in order of priority of highest to lowest, include:

- Structural repairs
- Dam, embankment and slope repairs
- Erosion repair
- Removal of debris and sediment
- Elimination of mosquito breeding areas
- Elimination of trees, woody vegetation and any animal burrows on embankments
- General device maintenance
- Fence repairs, and
- Snow and ice removal.

Downstream side of a stormwater pond embankment where piping of flow is causing dam failure



18.4.2 Preventive maintenance

Preventive maintenance depends on the type of device for which maintenance is being undertaken. Swales and filter strips would need routine mowing to maintain performance while ponds may not need mowing more than annually. As such, prioritising is not as important as ensuring that it is done. Preventive maintenance includes:

- Grass mowing
- Grass maintenance
- Vegetative cover
- Trash and debris
- Sediment removal and disposal
- Mechanical components
- Elimination of mosquito habitat, and
- Other specific device maintenance requirements.

18.4.3 Aesthetic maintenance

Aesthetic maintenance primarily enhances the visual appearance of a stormwater management device. Aesthetic maintenance is most important at those devices that are highly visible and for those devices that are above ground rather than under it. The following activities can be considered as aesthetic maintenance.

- Graffiti removal
- Grass trimming

- Weed control
- Debris removal, and
- Miscellaneous items such as painting, tree pruning, leaf removal.

18.5 Disposal of removed contaminants

Inspections determine when contaminant removal is needed for each stormwater management device. When contaminant removal is undertaken the sediments or water removed from the individual devices cannot be considered as clean and must be taken to a landfill or a designated contaminant disposal site.

Internationally, data has been collected to document contaminant levels that may exist in stormwater device sediments. Most of the information relates to concentrations of heavy metals and nutrients in sediments but not much data exists on organic contaminants such as petroleum hydrocarbons.

Table 18-10 summarises the concentrations of heavy metals in stormwater sediments from different types of devices serving a variety of land uses, while Table 18-11 summarises the concentrations of heavy metals in the sediments of stormwater devices serving different land uses.

The data in both tables is for surficial sediments (the top 25 mm). Five of the sites also included data from different layers of the stormwater sediments. The concentrations of heavy metals were highest in surficial layers, but diminished rapidly within the top 200 mm of sediments.

Table 18-10: Heavy metal concentrations in sediments from stormwater devices¹⁷⁸

Stormwater practice	Number of observations/site	Concentration (mg/kg)					
		Cd	Cr	Cu	Ni	Pb	Zn
Wet pond	430/21	3.6	83.3	25.6	13.1	227	150
Swale	9/3	5.5	69.7	89.5	35.6	1060	497.3
Infiltration trench	2/1	3	14.5	8	NA	80	80

Table 18-11: Heavy metal concentrations from stormwater devices by land use type¹⁷⁸

Land Use	Number of Observations/site	Concentration (mg/kg)					
		Cd	Cr	Cu	Ni	Pb	Zn
Single family residential	75/3	2.1	17.4	9.1	8	29.2	29.9
Multi family residential	15/1	1.2	3.2	21.2	7.2	32	22.2
Commercial	17/4	2.3	14.2	26.3	6.4	110.2	150.9
Mixed commercial and residential	57/3	2.7	14.8	26.1	4	351.6	176.1
Highways	313/14	5.7	51.3	54	26.1	676.8	298.4

As can be seen from the reported contaminant levels in these two tables, the sediment removed from stormwater devices is not clean. Sediments removed from stormwater devices should be taken to landfills.

If local councils have guidelines that meet or exceed those presented above, there is no requirement to only go by the information presented in this section.

¹⁷⁸ Livingstone et al, 1995

18.6 Safety issues

The importance of safety when conducting maintenance inspections needs to be stressed. Often a single individual will inspect stormwater management devices and their safety must be considered the highest priority when undertaking inspections or when maintenance is being undertaken.

Safety concerns during inspections are common sense. Possible concerns can include:

- Looking out for holes. Holes can indicate a serious problem or just provide an opportunity to twist an ankle but an inspector must always look where they walk.
- Use caution opening manholes or other structural covers. They can be very heavy can slip and cause serious injury. In addition they are heavy and improper handling can cause back pain.
- Never enter a confined space unless proper certification has been obtained.
- Do not enter pipes or conduits, even with others present, if there is concern about the pipes structural integrity.
- Be careful of steep slopes or entering water where the depth is unknown.
- Take care around nails, broken glass, needles or sharp objects. Always wear safety shoes.
- Gloves should be worn when handling mechanical or structural parts.
- Always wash hands after an inspection.
- In areas of poor ventilation don't light matches, lighters or cigarettes until venting has occurred.
- Always be careful. Roads can be dangerous and care must be taken to be well away from traffic.
- Always wear safety equipment.

Care should be taken when removing manhole covers



18.7 Inspection reports and operational notes

Stormwater management inspection documentation, monitoring analyses and file information must be located and maintained in an area on-site for commercial or industrial sites and be readily available for council to review.

Location of maintenance information for residential properties must be located in a well-documented location either at a council office or at a body corporate location known by council.

18.8 As-built certification

Appendix A has a form that can be completed (when required) for certification that construction of stormwater management devices was undertaken according to the approved design.

This form includes checking on the various stages of construction along with photo documentation. This certification further ensures that stormwater management devices will function as designed and reduce potential maintenance issues.

The last items in Appendix A are forms that can be used for maintenance inspections to ensure that all pertinent elements of a given device are checked for continued functionality and performance.

References

- Allibone R, Horrox J, Parkyn S 2001. Stream classification and instream objectives for Auckland's urban streams. National Institute of Water and Atmospheric Research client Report for Auckland Regional Council, ARC00257.
- ANZECC 2000. National water quality strategy: Australian and New Zealand guidelines for fresh and marine water quality. Canberra, Australian and New Zealand Environment and Conservation Council and Agriculture and Resources Management Council of Australia and New Zealand.
- Auckland Regional Council 1999. Environmental operations plan booklet. Auckland, Auckland Regional Council.
- Auckland Regional Council 1999. Guidelines for stormwater runoff modelling in the Auckland Region. Technical Publication Number 108. Auckland, Auckland Regional Council.
- Auckland Regional Council 2000. Low impact design manual for the Auckland Region. Technical Publication 124. Auckland, Auckland Regional Council.
- Auckland Regional Council 2003. Stormwater management devices: Design guidelines manual. 2nd ed. Technical Publication Number 10. Auckland, Auckland Regional Council.
- Auckland Regional Council 2004. Blueprint for monitoring urban receiving environments. Rev. ed. Technical Publication No. 168. Auckland, Auckland Regional Council.
- Auckland Regional Council 2010. Development of the contaminant load model. Auckland Regional Council Technical Report 2010/004. Auckland, Auckland Regional Council.
- Baginska B, Lu Y, Pritchard T 2005 (Modified in 2012). Modelling nutrient loads to better manage impacts of urbanisation in Tweed Catchment, New South Wales, Australia. Water & Catchments Science Section. Department of Environment & Conservation. Sydney, Dept. of Environment & Conservation.
- Bay of Plenty Regional Council 2012. Stormwater management guidelines for the Bay of Plenty Region. Bay of Plenty guideline 2012/01. Whakatane, Bay of Plenty Regional Council.
- Beca Carter Hollings & Ferner 2001. Stream erosion: A hydrological basis for management. Prepared for Auckland Regional Council.
- Beca Carter Hollings & Ferner 2014. Flat Bush catchment management implementation plan. Version A6. Prepared for Manukau City.
- Black P 1980. Water quality patterns during a storm on a mall parking lot. Water Resources Bulletin 16, 4, 615.
- Buchanan K, Clarke C, Voyde E 2013. Hydraulic energy management: inlet and outlet design for treatment devices. Prepared by Morphum Environmental for Auckland Council. Auckland Council Technical Report TR2013/018.
- California Stormwater Quality Association 2003. California stormwater best management practice handbook: New development and redevelopment. Menlo Park, Calif. California Stormwater Quality Association.
- Cappiella K, Fraley-McNeal L, Novotney M, Schueler T 2008. The next generation of stormwater wetlands. Wetlands & Watersheds Article #5. Prepared for Office of Wetlands, Oceans and Watersheds, U.S. EPA.

- Carr DW 1999. An assessment of an in-line alum injection facility used to treat stormwater runoff in Pinellas County, Florida. Sixth Biennial Stormwater Research & Watershed Management Conference.
- Center for Watershed Protection 2001. The practice of watershed protection. Ellicott City, Maryland, Center for Watershed Protection.
- Center for Watershed Protection 2003. Impacts of impervious cover on aquatic systems. Ellicott City, Maryland, Center for Watershed Protection.
- Chow VT 1959. Open channel hydraulics. New York, McGraw-Hill.
- Christchurch City Council 2003. Waterways, wetlands and drainage Guide, Part B: Design. Christchurch, Christchurch City Council.
- City of Portland 2000. Stormwater management manual: Adopted 1 July, 1999. Revised 1 September, 2000. Portland, City of Portland.
- Clar ML, Barfield BJ 2004. Stormwater best management practice design guide, volume 1: General considerations. EPA-600/R-04/121. Washington DC, United States Environmental Protection Agency.
- Clearwater S, Valler T 2012. Contaminants in Hamilton's urban stream sediments and ecotoxicity to amphipods. National Institute of Water and Atmospheric Research. Prepared for Waikato Regional Council. Document #2275458.
- Collier K, Kelly J 2006. Patterns and trends in the ecological condition of Waikato Streams based on the monitoring of aquatic invertebrates from 1994 to 2005. Environment Waikato Technical Report 2006/04. Hamilton, Waikato Regional Council (Environment Waikato).
- Collier K, Clements B, David B, Lake M, Leathwick J 2010. Significant natural areas of the Waikato Region: streams and rivers. Environment Waikato Technical Report 2010/19. Hamilton, Waikato Regional Council (Environment Waikato).
- Cunningham A, Colibaba A, Hellberg B, Silyn Roberts G, Symcock R, Vigar N, Woortman W 2017. Stormwater management devices in the Auckland region. Auckland Council guideline document, GD2017/01.
- Davis ROE, Bennett HH 1927. Grouping of soils on the basis of mechanical analysis. United States Department of Agriculture. Departmental Circulation No. 419.
- Delaware Department of Natural Resources and Environmental Control. Date unknown. Delaware erosion and sediment control handbook for development. Dover, Delaware, Dept. of Natural Resources and Environmental Control.
- Delaware Department of Natural Resources and Environmental Control 1997. Conservation design for stormwater management: A joint effort between DNREC and the Environmental Management Center of the Brandywine Conservancy. Dover, Delaware, Dept. of Natural Resources and Environmental Control.
- Department of Building and Housing 2003. Compliance document for New Zealand Building Code. Clause E1 Surface Water. Reprinted September 2003. Wellington, Dept. of Building and Housing.
- Ding Y, Dresnack R, Chan PC 1999. Assessment of high-rate sedimentation processes: Microcarrier weighted coagulation jar tests. Prepared for the U.S. EPA. Contract number 7C-R364-NAFX. New Jersey, U.S.A.

- Ecology 2016. Stormwater treatment technologies approved through TAPE and CTAPE, <http://ecy.wa.gov/programs/wq/stormwater/newtech/technologies.html> [accessed June 2017]
- Edwards T, de Winton M, Clayton J 2009. Assessment of the ecological condition of lakes in the Waikato Region using LakeSPI – 2009. National Institute of Water and Atmospheric Research. Client report for Waikato Regional Council (Environment Waikato). Document #1506213.
- Elliott S, Sorrell B 2002. Lake managers' handbook: Land-water interactions. Prepared for the Ministry for the Environment. ME number 442. Wellington, Ministry for the Environment.
- Environment Waikato (Waikato Regional Council) 2008. The health of the Waikato River and catchment: Information for the Guardians Establishment Committee. Hamilton, Environment Waikato.
- Facility for Advancing Water Biofiltration 2008. Fawb-day1-performance. <http://www.monash.edu.au/fawb/products/fawb-day1-performance.pdf>. [accessed June 2017]
- Facility for Advancing Water Biofiltration 2008. Guidelines for soil media in bioretention systems. Version 2.01. Clayton, Vic., Monash University.
- Fassman-Beck E, Simcock R 2013. Living roof review and design recommendations for stormwater management. Prepared by Auckland UniServices for Auckland Council. Auckland Council Technical Report TR2013/045.
- Fletcher T, Duncan H, Lloyd S, Poelsma P 2004. Stormwater flow and quality and effectiveness of stormwater treatment measures. CRC for Catchment Hydrology. Melbourne, Monash University.
- Fortier S 1926. Maximum permissible velocities recommended and the corresponding unit-tractive force values. Recommended for use in 1926 by the Special Committee on Irrigation Research of the American Society of Civil Engineers.
- Fortier S, Scobey FC 1926. Permissible canal velocities. Transactions of the American Society of Civil Engineers, v. 89, Paper no. 1588, p. 940-984
- Geological and Nuclear Sciences 2007. Groundwater quality in New Zealand: State and trends 1995 – 2006. Published by the Ministry for the Environment, Publication number: ME 831 August 2007. Wellington, Ministry for the Environment.
- Hawke's Bay Regional Council 2009. Guidelines for waterways: Industrial stormwater design guidelines for the Hawke's Bay Region. Technical Guidelines M08/13 related to Guidelines for Waterways. Napier, Hawke's Bay Regional Council.
- Hawke's Bay Regional Council 2009. Industrial stormwater design guidelines for the Hawke's Bay Region, Technical Guidelines AM08/13 related to Guidelines for Waterways. Napier, Hawke's Bay Regional Council.
- Herald JR 1989. Hydrological impacts of urban development in the Albany Basin, Auckland, A thesis presented in fulfilment of requirements for the degree of Doctor of Philosophy in Geography. Department of Geography. University of Auckland.
- Hoey J, Girts M 2000. Technical memorandum: Stormwater management cost Information. Prepared for Washington Stormwater Policy Advisory Committee.

- Horner RR, Skupien J, Livingston E, Shaver E 1994. Fundamentals of urban runoff management: Technical and institutional issues. Terrene Institute in cooperation with the U.S. Environmental Protection Agency. Washington, D.C., Terrene Institute.
- Horner RR, May CW 1999. Regional study supports natural land protection as leading best management practice for maintaining stream ecological integrity, Comprehensive Stormwater and Aquatic Ecosystem Management. First South Pacific Conference.
- Ira SJT, Roa A, Carter R 2016. Understanding and determining the cost of long term maintenance and resilience of WSD. Conference paper at Water New Zealand's Stormwater Conference 2016.
- Jenkins B, Vant B 2007. Potential for reducing the nutrient loads from the catchments of shallow lakes in the Waikato Region. Prepared for Waikato Regional Council (Environment Waikato). Document #1077213.
- Jowett I G, Elliott A 2005. Cohesive sediment design parameters for Auckland streams. Prepared for the Auckland Regional Council. NIWA Client Report.
- Julian JP, Torres R 2006. Hydraulic erosion of cohesive riverbanks. Department of Geological Sciences, University of South Carolina. *Geomorphology* 76 (2006) 193-206.
- Kadlec RH, Knight RL 1996. Treatment wetlands. Boca Raton, Florida, CRC Press.
- Kennedy P 2003. The effects of road transport on freshwater and marine ecosystems. Wellington, Ministry of Transport (June 1999 and updated October 2003).
- Kingett Mitchell Ltd, Diffuse Sources Ltd 2003. A study of roof runoff quality in Auckland New Zealand: Implications for stormwater management. Auckland Regional Council technical publication 213. Auckland, Auckland Regional Council.
- Koh S 2016. Average days between rains per month. Personal communication dated 12 August 2016. Waikato Regional Council staff member.
- Larcombe M 2002. Design for vegetated wetlands for the treatment of urban stormwater: A monitoring report. Prepared for the Auckland Regional Council.
- Larcombe M 2003. Removal of stormwater contaminants using grass swales. Prepared for the Auckland Regional Council.
- Lawless JV, Lovelock BG 2001. New Zealand's geothermal resource base. New Zealand Geothermal Association Seminar, Taupo. New Zealand Geothermal Association.
- Lewis M, Simcock R, Davidson G, Bull L 2010. Landscape and ecology values within stormwater management. Prepared by Boffa Miskell for Auckland Regional Council. Auckland Regional Council Technical Report TR2009/083. Auckland, Auckland Regional Council.
- Livingston EH, Cox JH 1995. Stormwater sediments: Hazardous waste or dirty dirt? Proceedings of the 4th Biennial Stormwater Research Conference, South West Florida Water Management District.
- Maryland Department of Natural Resources 1982. The effects of alternative stormwater management design policy on detention basins. Baltimore, Maryland, Maryland Department of Natural Resources.
- Maryland Department of Natural Resources 1984. Standards and specifications for infiltration practices. Water Resources Administration. Baltimore, Maryland, Maryland Department of Natural Resources.

- Maryland Department of the Environment 2000. Maryland stormwater design manual, Volumes I & II. Baltimore, Maryland, Maryland Dept. of the Environment.
- Maxted JR, McCready CH, Scarsbrook MR 2005. Effects of small ponds on stream water quality and macroinvertebrate communities. *New Zealand Journal of Marine and Freshwater Research* 39: 1069-1084.
- Mazer G, Booth D, Ewing K 2001. Limitations to vegetation establishment and growth in biofiltration swales. *Ecological Engineering* 17 (4): 429-443.
- McCuen RH, Moglen GE, Kistler EW, Simpson PC 1987. Policy guidelines for controlling stream channel erosion with detention basins. College Park, Maryland, Dept of Civil Engineering, University of Maryland.
- McCuen RH 1989. Hydrologic analysis and design. 2nd ed. Englewood Cliffs, N.J, Prentice-Hall.
- McDowall RM 1990. New Zealand freshwater fishes: A natural history and guide. Rev. ed. Auckland, Heinemann Reed / MAF Publishing Group.
- McIntosh J 2004. Assessment of nutrient reduction treatments (Forest Research and URS). Report to the Regulation & Monitoring Committee, meeting of 23 November 2004.
- Ministry for the Environment 1998. Environmental guidelines for water discharges from petroleum industry sites in New Zealand. Prepared for a Joint Working Group of the Ministry for the Environment, local authorities and petroleum marketing companies. Wellington, Ministry for the Environment.
- Ministry for the Environment 2010. Tools for estimating the effects of climate change on flood flows: A guidance manual for local government in New Zealand. Wellington, Ministry for the Environment.
- Ministry of Works and Development 1978. Culvert manual, volume 1. Civil Division Publication CDP 706/A. Wellington, Ministry of Works and Development.
- Minton GR 2002. Stormwater treatment: Biological, chemical and engineering principles. Resource Planning Associates.
- Minton GR 2006. Treatment trains, don't get run over. *Stormwater Journal for Surface Water Quality Professionals*, July/August.
- Mitchell C 1996. Pollutant removal mechanisms in artificial wetlands. Course notes for the 1996 International Water Environmental School. Gold Coast, Australia.
- Municipality of Metropolitan Seattle 1992. Biofiltration swale performance, recommendations and design considerations. Water Pollution Control Department. Publication 657. Seattle, Municipality of Metropolitan Seattle.
- New York State Department of Environmental Conservation 2003 (modified in 2008). New York State Stormwater Management Design Manual, Appendix A. Calculating Urban Stormwater Loads. Albany, NY, State Dept. of Environmental Conservation.
- New Zealand Geotechnical Society 2017. Ground investigation specification, Volume 1. ISBN: 978-1-98-851731-5.
- New Zealand Transport Agency 2010. Stormwater treatment standard for state highway Infrastructure. Wellington, New Zealand Transport Agency.

- New Zealand Water Environment Research Foundation 2004. On-site stormwater management guideline. Wellington, NZ Water Environment Research Foundation.
- NIWA 1995. A guide to probable maximum precipitation in New Zealand. Science and Technology Series No. 19. Wellington, National Institute of Water & Atmospheric Research (NIWA).
- North Shore City Council July 2008. North Shore City Council Bioretention Guidelines (First Edition). Auckland, North Shore City Council.
- North Shore City Council 2001. North Shore City Council coastal outfalls. Report prepared by Beca Carter Hollings and Ferner.
- North Shore City Council 2008. Rain tank guidelines. Auckland, North Shore City Council.
- Orsense R, Prender M, Asadi M B, Asadi M S 24 November 2017. Dynamic behaviour of undisturbed natural pumiceous soils. 20th New Zealand Geotechnical Society Symposium. https://www.nzgs.org/library/nzgs20_asadi/
- Parkyn S, Phillips N, Smith B 2006. Aquatic invertebrate biodiversity and spatial characterisation of non-perennial streams in native forest in the Waikato Region. Environment Waikato Technical Report 2006/38. Hamilton, Waikato Regional Council (Environment Waikato).
- Patterson M, Cole A 1998. The economic value of ecosystem services in the Waikato Region. Report prepared for Environment Waikato. Palmerston North, Massey University.
- Pitt R 2012. Compacted urban soils and their remediation. An article prepared for Aqua Terra International Ltd. Stormwater Meanderings Newsletter, Issue 8, March.
- Quinn JM, Steele GL, Hickey CW, Vickers ML 1994. Upper thermal tolerances of twelve New Zealand stream invertebrate species. New Zealand Journal of Marine and Freshwater Research 28: 391-397.
- Richardson J, Boubee JAT, West DW 1994. Thermal tolerance and preference of some native New Zealand freshwater fish. New Zealand Journal of Marine and Freshwater Research 28: 399-407.
- Rodney District Council, Waitakere City Council 2009. The countryside living toolbox: A guide for the management of stormwater discharges in countryside living areas in the Auckland Region. Auckland, Auckland Regional Council.
- Rose C 2013. General outline and structure for preparing TMDL reports, Appendix F: export coefficient model. San Luis Obispo, California Regional Water Quality Control Board, Central Coast Region.
- Rosgen D 1996. Applied river morphology. Pagosa Springs, Colorado, Wildland Hydrology.
- Rowe D, Quinn J, Parkyn S, Collier K, Hatton C, Joy M, Maxted J, Moore S 2006. Stream ecological valuation (SEV): A method for scoring the ecological performance of Auckland streams and for quantifying mitigation. Auckland Regional Council. Technical Publication No 302. Auckland, Auckland Regional Council.
- Scarsbrook M, Wright-Stow A, Joute-Howes K, Joy K 2008. Aquatic ecosystems of the Maniapoto karst. Environment Waikato Technical Report 2008/31. Hamilton, Waikato Regional Council (Environment Waikato).

- Semadeni-Davies A 2009. Fall velocities of stormwater sediment particles. Literature review. Prepared by NIWA Ltd for Auckland Regional Council. Auckland Regional Council Technical Report 2009/035.
- Shaver E 2000. Low impact design manual for the Auckland Region. Auckland Regional Council Technical Publication No. 124. Auckland Regional Council, Auckland.
- Shaver E, Horner R, Skupien J, May C, Ridley G 2007. Fundamentals of urban runoff management: Technical and institutional Issues. 2nd ed. North Atlantic Lake Management Society.
- Shaver E 2009. Low impact design versus conventional development: Literature review of developer-related costs and profit margins. Prepared by Aqua Terra International Ltd for Auckland Regional Council. Auckland Regional Council Technical Report 2009/045.
- Simons MJ 1986. Effects of elevated temperature on three migratory fish from the Waikato River. Technical Publication 40. Hamilton, New Zealand, Waikato Valley Authority.
- Somes N, Crosby J 2007. Review of street scale WSUD in Melbourne study findings, Kingston City Council and the Better Bays and Waterways Institutionalising Water Sensitive Design and Best Management Practice Project (revised).
- Speirs D 2001. The diversity and distribution of freshwater fish and their habitat in the major rivers of the Waikato Region. Environment Waikato Technical Report 2001/11. Hamilton, Waikato Regional Council (Environment Waikato).
- State of New Jersey Department of Environmental Protection 2004. New Jersey stormwater best management practices manual. New Jersey Department of Environmental Protection website, [accessed June 2017]
http://www.njstormwater.org/bmp_manual/NJ_SWBMP_4%20print.pdf
- State of New Jersey Department of Environmental Protection 2016. New Jersey Department of Environmental Protection website, www.nj.gov/dep/ [accessed June 2017].
- Steiner M, Goosse P, Rutz F, Brodmann R, Pazeller A 2010. Straßenabwasserbehandlungsverfahren, Stand der Technik. Bundesamt für Straßen ASTRA. Bundesamt für Umwelt BAFU, Bern, pp. 1–130 (in German).
- Taylor A 2001. The freshwater macroinvertebrate communities of the Waikato, Waihou and Waipa Rivers. Environment Waikato Technical Report 2001/12. Hamilton, Waikato Regional Council (Environment Waikato).
- Thompson PL, Kilgore RT 2006. Hydraulic design of energy dissipators for culverts and channels. 3rd ed. Hydraulic engineering circular, Number 14 (HEC 14). Washington, D.C., U.S. Department of Transportation, Federal Highway Administration.
<https://www.fhwa.dot.gov/engineering/hydraulics/pubs/06086/hec14.pdf> [accessed June 2017]
- United States Environmental Protection Agency 1992. NPDES storm water sampling guidance document. Office of Water, United States Environmental Protection Agency.
- United States Environmental Protection Agency 1999. Guidance manual for the monitoring and reporting requirements of the NPDES multi-sector storm water general permit. Office of Water, United States Environmental Protection Agency.
- United States Environmental Protection Agency 2002. Urban stormwater BMP performance monitoring: A guidance manual for meeting the national stormwater BMP database

- requirements. Prepared by GeoSyntec Consultants, Urban Drainage and Flood Control District and Urban Water Resources Research Council of American Society of Civil Engineers. Office of Water, United States Environmental Protection Agency.
- URS Ltd 2005. Countryside living methods: Version 3.0. Prepared for Waitakere City Council and Rodney District Council.
- US Army Corps of Engineers 30 June 1994. Hydraulic design of flood control channels: Engineering Manual 1110-2-1601. Washington, USA, Department of the Army.
- Ven Te Chow 1964. Handbook of applied hydrology: A compendium of water-resources Technology. New York, McGraw-Hill.
- Waikato Regional Council 2020 in press. Waikato stormwater runoff modelling guideline. Waikato Regional Council Technical Report 2020/06.
- Ward J, Scrimgeour F 1991. Auckland regional stormwater project: An economic view. Working Report #55. Auckland, Auckland Council
- Washington State Department of Ecology 2000. Stormwater management manual for Western Washington, Volume 5: Runoff treatment BMP's. Publications No. 99-15. Lacey, Washington, Dept. of Ecology.
- Washington State Department of Ecology 2001. Stormwater management manual for Western Washington, Volume 1: Minimum technical requirements for site planning. Publication Numbers 99-11 through 99-13. Lacey, Washington, Dept. of Ecology.
- Washington State Department of Transportation 1995. Highway runoff manual. Olympia, Washington, Washington State Dept. of Transportation.
- Watershed Management Institute 1997. Institutional aspects of urban runoff management: A guide for program development and implementation. Ingleside, Maryland, Watershed Management Institute.
- Watershed Management Institute 1997. Operation, maintenance and management of stormwater management systems. In cooperation with Office of Water, U.S. Environmental Protection Agency, Washington DC. Ingleside, Maryland, Watershed Management Institute.
- Wildland Consultants Ltd 2009. Methodologies for ranking of lake ecosystems for biodiversity management in the Waikato Region. Report No. 2029. Prepared for Waikato Regional Council (Environment Waikato).
- Wildland Consultants Ltd 2011. Geothermal vegetation of the Waikato Region: An update based on 2007 aerial photographs. Waikato Regional Council Technical Report 2011/29. Hamilton, Waikato Regional Council.
- Wong T, Breen PF, Somes NLG, Lloyd SD 1999. Managing urban stormwater using constructed wetlands. 2nd ed. Industry Report, Report 98/7. Cooperative Research Centre for Catchment Hydrology and Department of Civil Engineering of Monash University. Clayton, Vic. Dept. of Civil Engineering, Monash University.
- Wood M 2014. Managing land use change and Council's administered drainage areas. Waikato Regional Council Technical Report 2014/13. Hamilton, Waikato Regional Council.

Appendix A: Glossary of terms

Much of this information has been adapted from a variety of sources including a 'Glossary of Stormwater Terms' prepared by Auckland Council, March 2016.

Absorption	Attachment of chemicals to sediments by association with solids within the sediment particles.
Adsorption	Attachment of chemicals to sediment surfaces.
AEP	Annual Exceedance Probability event - the probability that a given rainfall total accumulated over a given duration will be exceeded in any one year.
Aquifer	Describes underground layers of saturated permeable material that can both hold and let water move through the ground.
ARI	Average Recurrence Interval - the average or expected value of the periods between exceedances of a given rainfall total accumulated over a given duration.
As Built Plan	Plans showing details of fittings and connections on a site. May also show new public assets and their connection to existing networks.
Baffle	Is a device used to deflect or regulate water flow. They may also be used to improve sediment removal by increasing flow paths.
Baseflow	Sustained residual flow in streams. Excludes quickflow or stormflow. Usually results from groundwater inflow or release of flow from the root zone.
Best practicable option (BPO)	In relation to a discharge of a contaminant or an emission of noise, means the best method for preventing or minimising the adverse effects on the environment having regard, among other things, to: a) The nature of the discharge or emission and the sensitivity of the receiving environment to adverse effects, and b) The financial implications, and the effects on the environment, of that option when compared with other options, and c) The current state of technical knowledge and the likelihood that the option can be successfully applied.
Bubble up	Describes a catchpit that does not have an outlet pipe. It allows catchpit water to bubble up and flow overland to the nearest receiving environment.
Bund	A barrier, dam or mound used to contain or deflect substances. Often used to prevent spills on industrial sites.
Catchpit	A stormwater device composed of a grate, small chamber and a sediment sump area. They may be private or public and are usually associated with drainage of roading or driveways.
Catchment area	The area contributing runoff to a single point measured in a horizontal plane, which is enclosed in a ridge line.
Catchment Management Plan	Plan for addressing runoff generated in a catchment to meet specific water quantity and/or water quality objectives.

Chamber	The area within manholes and catchpits where stormwater goes before going out through the pipes.
Channels, streams and water courses	A channel is a built feature that carries surface water and is open to the air. Streams are natural systems and a watercourse is a generic term that covers both channels and streams.
Check dam	Small dam constructed in a gully, swale or other small watercourse to decrease the stream stormwater flow velocity.
Culvert`	Pipe or concrete box structure to convey surface water flow
Dam	Stores surface water to control flooding, supply drinking water, power generation or irrigation.
Detention pond	A permanent structure for the temporary storage of stormwater runoff that is designed so as not to create a permanent pool of water.
Debris screen	Used in watercourses or at pipe inflows or outflows to capture debris and prevent debris conveyance downstream.
Downpipe	Pipes from guttering to the ground that carries rainwater to a stormwater system.
Embankment	Mound or wall of soil or other material that impounds water.
Emergency	Path designed to be taken by runoff when the capacity of a pond Spillway or dam is exceeded by a rain event.
Energy dissipater	Rocks or concrete pads constructed at outlets to slow or regulate water flow and reduce erosion potential.
Erosion	Abrasion, detachment and removal of soil by rain, flowing water, wind, frost, temperature change or other natural or human-made cause.
Extended detention	Temporary impoundment of stormwater over a specified period of time to a downstream receiving system for the purpose of water quality treatment or stream channel erosion control.
Filter strip	A densely vegetated section of land engineered to accept stormwater runoff as overland sheet flow from upstream development.
Filtration device	Device that passes stormwater through a porous media filter.
First flush	The delivery of a disproportionately large load of contaminants during the early part of storms.
Fish ladder	Device used to enable fish species to climb barriers to travel further upstream from a potential blockage to migration.
Floodplain	Area that catchment flows cover when stream channel conveyance is exceeded. It is normally recognised as an area that becomes inundated in storms up to and including a 1 in 100-year runoff event.
Freeboard	The vertical distance between the design water surface elevation and the elevation of the top of a tank wall or pond embankment.

Grease trap	A device to prevent grease and solids entering the stormwater/wastewater network.
Groundwater	Water that has infiltrated the ground to subsoil and bedrock. During dry periods, stream flow is maintained by groundwater.
Groundwater recharge	Replenishment of groundwater reservoirs.
Gutter/spouting	Narrow trough fixed under the eaves of a structure for conveying rainwater to downpipes.
Impervious surfaces	Hard surfaces that prevent or retard the entry of water into soil.
Infiltration	Passage or movement of water from the land surface into the soil.
Infiltration device	A stormwater management device that temporarily impounds stormwater runoff and discharges it through the surrounding soil.
Inlet	Entry point of a pipe to a stormwater management device, a piped drainage network or a receiving system.
Invert	Bottom of a pipe, channel or stormwater device.
Kerb outlet	Stormwater discharge point into a roadway that is collected from a property in a pipe.
Live storage	Storage volume of the device excluding the volume that is permanently filled with water.
Low impact design (LID)	A design approach for site and catchment development or re-development that protects and conserves and incorporates natural site features into stormwater management design and implementation.
Manhole	Chamber that provides entry to a piped network. Access is provided via a cover.
Oil/water separator	A device used to separate oil from water.
100-year floodplain	Land which may be inundated with water statistically once every 100 years. It can occur during any year.
Orifice	Small outlet from a stormwater device that controls outflow rates.
Outfall	End of a stormwater pipe or network where water leaves the built stormwater system and enters a receiving environment.
Overland flow path	Route taken by runoff not captured in a reticulated or natural stormwater system. It flows over the ground and can concentrate in gullies.
Permeable/porous	Natural ground surfaces, including trees, shrubs, grass and soil which allow water to pass through and soak into the ground.

Permeable pavement	An open graded asphaltic or reticular concrete or other material that allows water to pass through it.
Pre-development	Conditions that exist at the time that plans for the land development of a tract of land are approved.
Post-development	Conditions that reasonably may be expected or anticipated to exist after completion of the land development activity on a specific site or tract of land.
Quickflow	The portion of flow that drains from the catchment during or shortly after a storm event.
Rain tank	An above or below ground tank that stores water collected from the roof area of a building.
Rain garden	Stormwater device that includes bioretention and bioretention devices that allow runoff to pass through a media and infiltrate the runoff or release it at a very slow rate through an underdrain.
Residence time	Time a small parcel of fluid spends in the treatment device.
Retention	Storage of runoff followed by infiltration or evaporation.
Reticulation	Piped stormwater network.
Riprap	Rock or other materials used to armour shorelines, streambeds and banks, bridge abutments, pilings and other structures against scour and water or ice erosion.
Riser	Underground, vertical section of a manhole which rises up from the pipes at the base to ground level. A riser assembly is also used in stormwater ponds to raise storage in the pond to the overflow level.
Runoff	Water flows which result from rain water that is not absorbed by permeable surfaces or drains from impermeable surfaces.
Sand filter	An above or below ground tank containing a bed of sand to filter stormwater runoff and remove contaminants.
Scruffy dome	A steel grill, usually domed, placed over an inlet or a manhole to allow stormwater runoff to enter a piped network but precludes larger debris from entering the network.
Sediment forebay	Small pool designed to capture coarse sediment
Seepage	A flow of subsoil water appearing at ground level in shallow excavations or from behind retaining walls. Seepage control is essential for reducing flow around pipes in dams.
Service outlet	Outlet used to pass flows less than flows for which emergency outlet is used but larger than flows through an extended detention outlet.
Sheet flow	Flows occurring as a sheet over the surface rather than channelised flow.
Soakage pit	An excavated area that remains below ground to accept stormwater runoff and allow it to soak into the ground.

Spillway	A large outlet (usually a weir) in an embankment used to pass flood flows.
Stop bank	An earth bund or embankment to prevent water flowing in a particular direction. Usually used to prevent frequent flooding, but generally is not designed to prevent all flooding.
Stormwater	The portion of precipitation that is discharged across land surfaces or through conveyances to receiving systems.
Stormwater	For quantity control, a system of vegetative and structural management measures that control the increased volume and rate of surface runoff caused by human made changes to the land; and For quality control, a system of vegetative, structural and other measures that reduce or eliminate contaminants that might otherwise be carried by stormwater runoff.
Subsoil	Beneath the topsoil, the subsoil does not have high organic matter concentrations so has lighter and varying colours.
Subsoil drain	An underground drainage system that allows for the collection and passage of subsoil water to a stormwater drain.
Swale	An earthen conveyance system that is broad and shallow with erosion resistant grasses and check dams, engineered to remove contaminants from stormwater runoff by filtration through grass and infiltration into the ground.
Topsoil	The top layer of soil that has a mix of vegetative matter and soil in it. Topsoil provides the richest amount of organic matter for germinating seeds and this organic matter colours the soil dark brown. Organic matter helps soil structure, holds water and nutrients. Microorganisms, from bacteria to fungi, populate the soil and keep the cycling of organic matter active.
Treatment device	A generic term to cover a wide range of devices to remove contaminants from stormwater runoff.
Tree pit	A stormwater filtering device that collects runoff from impermeable surfaces and filters the runoff through the tree roots and surrounding soil.
Underdrain	Drain used to collect and convey water that has passed through soil or a filter bed.
Water table	Level of the saturated portion of a groundwater aquifer.
Wetland	Areas that are inundated by surface or groundwater at a frequency and duration to support, and under normal circumstances do support, a prevalence of vegetation typically adapted for life in saturated soil conditions.

Appendix B: Low impact design scoring matrix

Table B-1: Low impact design scoring matrix

Implementation elements	Typical components	Scoring details	Score
Source control maximised	Water re-use	0-4 depending on % of runoff capture	
	Site disturbance reduced from a conventional development approach	0-3 depending on % of runoff capture	
	Impervious surfaces reduced from a traditional approach	0-3 depending on % of runoff capture	
	Use of building or site materials that do not contaminate	0 or 1 for residential 0-3 for commercial or industrial	
	Existing streams and gullies located on site (including ephemeral) are protected and enhanced. The entire stream other than possible crossings shall be protected to qualify for points.	0 or 3	
	Riparian corridors are protected, enhanced or created	0-3	
	Protection and future preservation of existing native bush areas	0-2 depending on percentage of site area	
LID stormwater device/practice used	Infiltration devices to reduce runoff volume	0-6 depending on % of runoff capture	
	Revegetation of open space areas as bush	0-3 depending on % of site covered	
	Bioretention	0-6 depending on % of runoff capture	
	Swales and filter strips	0-3 depending on % of runoff capture	
	Tree pits	0-6 depending on % of runoff capture	
Traditional mitigation	Constructed wetlands	0-4 depending on % of runoff capture	
	Wet ponds	0-1 depending on % of runoff capture	
	Proprietary devices	0-1 depending on % of runoff capture	
	Dry detention ponds	0	
Urban design	Stormwater management is designed to be an integral and well considered part of the urban design.	0-2	
Tangata whenu values	Stormwater management has been designed considering tangata whenua values and demonstrates that these have been incorporated into the design	0-2	
Total score			

The scoring matrix outlined above relates to stormwater management and focusses on encouraging LID in particular. This doesn't replace the need to consider other values including cultural, social, environmental and economic.

Whilst a number of the items outlined in the matrix are outside the scope of what is consented by the Waikato Regional Council, and relate to land use hence are under the jurisdiction of territorial authorities, it is important to consider how stormwater can be managed holistically irrespective of jurisdictions.

Once the total score is calculated, the minimum score in terms of acceptability is shown in Table B-2 and Table B-3Table 6-3 below. Scores lower than those shown will have to justify rejection for those items not incorporated.

Table B-2 shows the minimum target scores for the two main elements of the scoring matrix: source control and the inclusion of low impact design devices/practices within the proposed development. The target scores vary depending on whether there are existing natural features that need to be protected and what the design criteria are for the site.

Table B-2: Target scores (excluding highway projects)

Design criteria for the site	Existing natural features to protect			No existing natural features to protect		
	Source control target	LID devices target	Total target	Source control target	LID devices target	Total target
<ul style="list-style-type: none"> Water quality treatment required Peak flow control required Volume control required 	6	6	15	4	6	12
<ul style="list-style-type: none"> Water quality treatment required Peak flow control required 	6	4	13	4	4	10
<ul style="list-style-type: none"> Water quality treatment required Volume control required 	6	3	12	4	3	9
<ul style="list-style-type: none"> Water quality treatment required 	6	2	11	4	2	8

Highway projects are different from normal development projects and the ability to provide source control is limited. Highway projects must still consider LID and traditional mitigation devices and must achieve a score according to Table B-3Table 6-3.

Table B-3: Target scores for highway projects

Design criteria for the site	Existing natural features to protect	
	Yes	No
<ul style="list-style-type: none"> Water quality treatment required Peak flow control required Volume control required 	8	6
<ul style="list-style-type: none"> Water quality treatment required Peak flow control required 	6	4
<ul style="list-style-type: none"> Water quality treatment required Volume control required 	6	4
<ul style="list-style-type: none"> Water quality treatment required 	4	3

Waikato Regional Council recommends that stormwater management systems are located in public spaces (carriageways, drainage reserves, public open spaces) and that they are vested to territorial authorities to ensure that ongoing management of the systems is assured.

As stated in Section 1, the Waikato Regional Council uses a Best Practicable Option (BPO) approach for assessing the adequacy of technical design for discharge consents. As such, being unable or unwilling to meet the thresholds indicated above does not automatically mean the consent application will be declined. If an applicant chooses to use another approach to site development then an analysis should accompany the application to demonstrate that similar outcomes are achieved when compared to if a low impact design approach was taken.

Scoring matrix values

It is important to provide a consistent approach to selecting values for each category component. The following subsections provide scoring values for each component so that the values selected are not arbitrary.

Source control

1. Water re-use
 - Flow detention only is 1 point.
 - Site use for garden watering is 2 points.
 - Site use for garden watering and for non-potable inside waters uses including laundry and toilets is 3 points.
 - Site use for full water supply is 4 points
2. Site disturbance reduced from a conventional development approach
 - 10 % reduction from a conventional development is 2 points.
 - 20% and greater reduction from conventional development is 3 points
3. Impervious surfaces reduced from a conventional development approach
 - 5% reduction is 2 points.
 - 10% reduction is 3 points.
4. Use of building or site materials that do not contaminate
 - Residential roofs, gutters, down spouts made of non-contaminant leaching materials is 1 point.
 - Commercial roof, gutters, down spouts made of non-contaminant leaching materials is 3 points.
5. Existing streams and gullies (including ephemeral streams) are protected and enhanced
 - Preservation and protection of natural streams and gullies is 3 points.
6. Riparian corridors are protected, enhanced or created
 - Riparian corridor protection scores depend on the width of corridor provided. 5 metres on either side of the stream is 1 point, 10 metres is 2 points and greater than 10 metres is 3 points.
7. Protection and future preservation of existing native bush areas
 - Protection, preservation and, if needed, enhancement of native bush areas that exceed 10% of the site is given 2 points.

LID stormwater devices/practices used

1. Infiltration devices to reduce runoff volume
 - Meeting the capture and infiltration requirements of the initial abstraction volume is given 2 points.
 - Meeting the capture and infiltration requirements for the site water quality storm is given 3 points.
 - Meeting the capture and infiltration requirements for the 2-year ARI event for the site is given 6 points.
2. Revegetation of open areas as bush

- Planting open space and providing maintenance of planting for 3 years if open space is equal to or exceeds 10% of overall site area is given 3 points.
3. Bioretention (including tree pits)
 - Meeting the capture and retention requirements of the initial abstraction volume is given 2 points.
 - Meeting the capture and retention requirements for the site water quality storm is given 3 points.
 - Meeting the capture and retention requirements for the 2-year storm for the site is given 6 points.
 4. Swales and filter strips
 - All impervious surfaces draining to swales and filter strips that have capacity for treating and conveying the water quality event is given 2 points.
 - All impervious surfaces draining to swales and filter strips that have capacity for treating the water quality event and conveying the 2-year ARI event is given 3 points.
 5. Constructed wetlands
 - Meeting the water quality design storm criteria is given 2 points.
 - Meeting extended detention and peak control requirements is given an additional 2 points.

Traditional mitigation

1. Wet ponds
 - Use of a wet pond for stormwater quantity control and stream channel protection is 1 point.
2. Proprietary devices
 - Meeting water quality requirements using council accepted proprietary devices is given 1 point.
3. Dry detention ponds
 - As this device provides negligible water quality benefit, and generally has poor operation and performance in the long term, use of the device for quantity control is given 0 points.

Urban design

1. Stormwater management is designed to be an integral and well considered part of the urban design. 2 points can be obtained by demonstrating, in a narrative, how the site design incorporated LID principles into the overall site design.

Tangata whenua values

1. Stormwater management has been designed considering tangata whenua values and demonstrates that these have been incorporated into the design. 2 points can be obtained by demonstrating, in a narrative and with design components, how the stormwater management system incorporates tangata whenua values.

There will be situations in the source control and low impact design categories where the entire site cannot have a given device / practice or where a given category cannot achieve the level of coverage that point scores are based upon. In those situations, a pro-rata score can be achieved based on the percentage of coverage.

As an example, revegetation of open areas as bush that exceeds 10% of site area is awarded 3 points. If there is only space available for achieving 5% of site coverage, then using a pro-rata approach will allow for the award of 1.5 points for revegetation. A similar approach may be used for other items to determine an overall site score.

Appendix C: Forms for construction and operation

Forms for use when constructing or operating stormwater management devices

To facilitate proper construction and operation of stormwater management devices, this appendix has been prepared.

It is intended that these forms be used whenever there is a stormwater management device. Their use will facilitate proper construction and subsequent operation of the stormwater management devices.

Forms that are included include the following:

- Preconstruction meeting form
- Individual device construction checklists
 - Swales and filter strips
 - Sand filters
 - Rain gardens
 - Infiltration trenches
 - Ponds and wetlands
- As-built documentation forms
 - Swales and filter strips
 - Sand filter
 - Rain garden
 - Infiltration trench
 - Pond or wetland
- Post-construction operation and maintenance forms
 - Swales and filter strips
 - Sand filters
 - Rain gardens
 - Infiltration trenches
 - Ponds and wetlands
 - Oil/water separators

These forms have been adapted from forms prepared previously for the New Zealand Transport Agency and the Auckland Regional Council.

Pre-construction meeting form

STORMWATER MANAGEMENT PRE-CONSTRUCTION MEETING AGENDA

Prerequisites:

- Read consent report and conditions
- Ensure the appropriate people attend: Consent issuance authority representative, Project Engineer, Contractor.
- Prepare copies of construction check lists for all stormwater management devices to be used

Site Name: _____

Date: _____

Address: _____

Consent No: _____

File Number: _____

Contractor contact information:

Name: _____

Organisation: _____

Mailing address _____

Phone no. _____

Email _____

Stormwater project engineer contact information (individual responsible for inspecting and signing off key construction milestones and providing final as-builts):

Name: _____

Organisation: _____

Mailing address _____

Phone no. _____

Email _____

Consent issuance authority representative contact information:

Name: _____

Organisation: _____

Mailing address _____

Phone no. _____

Email

Other attendees at the meeting

Purpose

To coordinate stormwater management construction activities of the contractor with the project inspection staff and other interested parties such as the appropriate consenting authority, utility contractors, and sub-contractors. This meeting is to be held between all parties prior to any construction work on the project.

A pre-construction meeting provides the opportunity for all parties involved to discuss roles and responsibilities on the project. The importance of stormwater management should be discussed and the importance of proper construction of stormwater management devices should be emphasized. Having a pre-construction meeting is invaluable in preventing issues that may arise later. It also establishes good communication at the beginning of a project to prevent potential problems, potential enforcement and corrections to device construction that may not otherwise have been undertaken correctly.

Key discussion points

The following items need to be discussed so that a clear understanding of project elements, time frames and important project components are understood by all attendees.

- 1. Project Description. Make sure that the development and the proposed stormwater device construction agrees with the approved plan or plans

- 2. Delineation of lines of authority. Names and telephone numbers for the Contractor and others will be entered into the record. In addition, the individual designated by the contractor for construction of stormwater management devices shall be identified.

Name

Cell phone number

- 3. Proposed Starting Dates - Contractors and subcontractors - lead-in time and number of shifts or extra hours they propose to be working, any variation to normal working hours, etc.

Starting date _____

Unusual working times or days

4. Intended project schedule and overall time frame

5. Project phases in chronological order.

	<u>Approximate Date</u>
• Project initiation,	_____
• Implementation of erosion and sediment control,	_____
• Mass earthworks,	_____
• Final grade establishment,	_____
• Road construction,	_____
• Drainage system construction,	_____
• Construction of sediment controls to protect stormwater devices	_____
• Stormwater management device construction, Critical Stages:	
➤ _____	_____
➤ _____	_____
➤ _____	_____
➤ _____	_____
• Final stabilisation.	_____
• Removal of sediment controls	_____
• Utility construction	_____

6. Stormwater management issues:

- Are the approved plans and consent on-site? Yes No
If not, why? _____

- Stormwater management devices need to be reviewed. The construction checklists should be used to detail key stages of construction. Those devices on this project include:

- Stormwater consent requirements need to be gone over
- Time frame for construction of stormwater management devices

- Who will submit As Built Plans? _____

- Who will submit Operation and Maintenance Plans

The relationship between the contractor's as-builts and the stormwater project engineers as-builts to be discussed and agreed

- Who will submit the Planting Plan (if appropriate)

- _____
- There is a requirement that an inspection be undertaken at key stages of construction for stormwater management devices. These stages can be found on the "as-built" requirements forms and the key stages should be specifically identified and discussed,
 - Overall stormwater management device sizing undertaken according to approved plans?

Yes No

If not, what is the variance from the approved plans?

- Construction methodology and materials used to construct stormwater management devices shall be discussed. This would apply to embankment materials and compaction, filter media, vegetation, stone or gravel sizing, etc.,
- Outfall structure construction proposed with suitable energy dissipation,
- Site stabilisation requirements,
- Any variation from plans that have been approved,
- Routine inspections to check construction progress,
- Final inspection requirements,
- As built certification requirement including overland flow path dimensions,
- Waikato Regional Council inspection and enforcement policies.

7. Utility locations. Discussion needs to be held with utility contractors to determine where utilities are/will be located and when they will be constructed. In addition, it would be good if the names and phone numbers of utility contact persons could be obtained. Who is responsible for stabilizing areas disturbed by utility construction?

8. Plan errors and omissions. The contractor should discuss errors and omissions in the plans that are known to exist. Pre-construction minutes should reflect the

Contractor's knowledge of errors or omissions in detail. Errors or omissions identified include:

9. Conversion of sediment control structures to stormwater management structures. Is there a relationship between erosion and sediment control and storm water management (use of stormwater devices for erosion and sediment control). Procedures should be gone over for final maintenance before handing the device over to the responsible maintenance entity, if applicable.

10. Other consents review and discussion. Are there other consents that need to be discussed (sediment control, stream works, dam consent, etc.)? Those consents include the following:

11. Sensitive environmental issues. Discussion of any sensitive environmental issues (contaminated soils, stream protection, and coastal management areas. Listing of sensitive issues includes:

12. Time extensions for work. Submittal procedure for and needed time extensions.

13. Consultant interaction. If a Consultant is providing the construction engineering and inspection or materials testing; discuss the procedures, relationships and responsibilities that exist between the Consultant, Waikato Regional Council and the Contractor.

14. Consent transfer. Transfer of consent to the responsible maintenance entity:

When _____

How _____

Additional Notes:

Waikato Regional Council Representative

Date

Device construction forms

Construction forms are provided for the following devices:

- Swales and filter strips
- Sand filters
- Rain gardens
- Infiltration trenches
- Ponds and wetlands

The oil/water separators are prefabricated units so it is not necessary to have a separate inspection form for them.

Submit plan modifications as noted in written comments by

Other action taken to obtain needed corrections

Final inspection, project completed

Responsible person's signature: _____



STORMWATER POND AND WETLAND INSPECTION ADVICE

Responsible person: _____

Date: _____

Time: _____

Weather: Rainfall over previous 2-3 days? _____

Person contacted during visit: _____

Page 1 of 3

SEDIMENT / STORMWATER MANAGEMENT POND CONSTRUCTION CHECKLIST	✗	Needs immediate attention	✓	Okay	?	Clarification Required
	-	Not Applicable				

Pond and Wetland Components:									
Items Inspected	Checked		Satisfactory	Unsatisfactory		Checked		Satisfactory	Unsatisfactory
	Y	N				Y	N		
MATERIALS AND EQUIPMENT									
Pipe & appurtenances on-site prior to construction and dimensions checked									
1. Material (including protective coating, if specified)	Y	N			i) Anti-seep collars properly spaced & having watertight connections to pipe	Y	N		
2. Diameter	Y	N			ii) Backfill placed & tamped by hand under "haunches" of pipe	Y	N		
3. Dimensions of riser or pre-cast concrete outlet structure	Y	N			iv) Remaining backfill placed in max. 200mm lifts using small power tamping equipment until 600mm cover over pipe is reached	Y	N		
4. Required dimensions between water control structures (orifices, weirs, etc.) are in accordance with designed plans	Y	N			19. Pipe placement – Concrete pipe	Y	N		
5. Barrel stub for prefabricated pipe structures at proper angle for design barrel slope	Y	N			i) Pipe set on blocks or concrete slab for pouring of low cradle	Y	N		
6. Number & dimensions of prefabricated anti-seep collars	Y	N			ii) Pipe installed with rubber gasket joints no spalling in gasket interface area	Y	N		
7. Watertight connectors and gaskets	Y	N			iii) Excavation for lower half of anti-seep collar(s) reinforcing steel set	Y	N		
8. Outlet drain valve	Y	N			iv) Entire area where anti-seep collar(s) will come in contact with pipe coated with mastic or other	Y	N		
9. Appropriate compaction equipment available, including hand & small power tamps	Y	N			v) Low cradle & bottom half of anti-seep collar installed	Y	N		
10. Project benchmark near pond site	Y	N			vi) Upper half of anti-seep collar(s) formed with reinforcing steel set	Y	N		
12. Equipment for temporary de-watering	Y	N			vii) Concrete for collar of an approved mix & vibrated into place (Protected from freezing while curing, if necessary)	Y	N		
SUBGRADE PREPARATION									
13. Area beneath embankment stripped of all vegetation, topsoil, and organic matter	Y	N			ix) Forms striped & collar inspected for honeycomb prior to backfilling. Parge if necessary	Y	N		
14. Cut-off trench excavated a minimum of 1 metre below subgrade and minimum 1 metre below proposed pipe invert, with side slopes no steeper than 1:1	Y	N			20. Pipe placement - Backfilling				
15. Impervious material used to backfill cut-off trench	Y	N			i) Fill placed in maximum 200mm lifts	Y	N		
PIPE SPILLWAY INSTALLATION									
16. Method of installation detailed on plans	Y	N			ii) Back fill taken minimum 600mm above top of anti-seep collar elevation before traversing with heavy equipment	Y	N		
17. Bed Preparation	Y	N			RISER / OUTLET STRUCTURE INSTALLATION				
i) Installation trench excavated with 1:1 side slopes	Y	N			21. Pre-cast concrete structure				
ii) Stable, uniform, dry subgrade of relatively impervious material (If subgrade is wet, contractor shall have to defined steps before proceeding with installation)	Y	N			i) Dry and stable subgrade	Y	N		
iii) Invert at proper elevation and grade	Y	N			ii) Riser base set to design elevation	Y	N		
18. Pipe placement – Metal / Plastic pipe	Y	N			iii) If more than one section, no spalling in gasket interface area: gasket or approved caulking material placed securely	Y	N		
i) Watertight connectors & gaskets properly installed	Y	N							

ACTION TO BE TAKEN:

No action necessary. Continue routine inspections? Y / N

Correct noted site deficiencies by

1st Notice:

2nd Notice:

Submit plan modifications as noted in written comments by

Final inspection, project completed

Responsible person's signature:

As-built documentation forms

Individual As-Built documentation of stages of construction is provided for each device other than the oil/water separator. That device does not have an “As-Built” plan requirement as they are pre-fabricated units and the only item of concern is the elevation they are placed at.

The “forms” for each device are provided on individual sheets for ease of reproduction.

As-Built Certification for Completed Stormwater Management Devices – Swale and/or Filter Strip

Site Name
Address
Engineer

Consent Number
Date

The following information must be completed and submitted with the As-Built drawing of the stormwater management swales or filter strips.

Stormwater Management Swale or Filter Strip As-Built Items to be included in the As-Built Plan submission as required.

It is necessary that photographic evidence be submitted to document stages of construction. Where large boxes are provided, please place an image or submit pictures of that stage to verify that construction was undertaken according to the plan.

- | | | |
|---|---------------------------------|--------------------------------|
| 1. Is the size and location of the swale or filter strip according to the approved plans? | Yes
<input type="checkbox"/> | No
<input type="checkbox"/> |
| 2. Are the lateral slopes completely level? | Yes
<input type="checkbox"/> | No
<input type="checkbox"/> |
| 3. Are the longitudinal slopes within the design range? | Yes
<input type="checkbox"/> | No
<input type="checkbox"/> |
| 4. Are check dams and level spreaders installed and spaced correctly? | Yes
<input type="checkbox"/> | No
<input type="checkbox"/> |
| 5. Are level spreaders constructed completely level? | Yes
<input type="checkbox"/> | No
<input type="checkbox"/> |
| 6. Are all inlets, outlets and bypasses installed correctly? | Yes
<input type="checkbox"/> | No
<input type="checkbox"/> |
| 7. Are kerb cuts installed per plans? | Yes
<input type="checkbox"/> | No
<input type="checkbox"/> |

8. Does the vegetation comply with planting specifications and is topsoil adequate in composition and placement?

Yes No

9. Are erosion control measures in place and adequate to protect the swale from excess sedimentation?

Yes No

10. Is overall construction undertaken according to plans?

Yes No

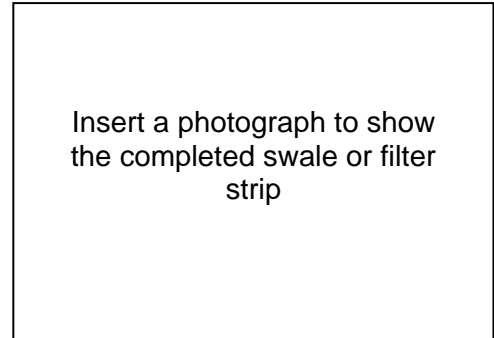

11. Verify locations and locate on as-built plans all utilities that may impact on future maintenance.

Yes No

For all those items listed above where "No" has been marked, please provide a discussion of the variation of those items from the consented design and why they are at variance. It is also requested that you state that the exceptions to the approved design do not adversely affect the intended performance or safety of the swale or filter strip. If you cannot state that there is no adverse effect, you must also note to that effect.

Horizontal lines for providing a discussion of variations.

The exceptions to the approved design do not adversely affect the intended performance or safety of the swale or filter strip.

I certify that this stormwater management swale or filter strip is constructed according to the consented design. This statement has been based upon on-site observation of the swale or filter strip conducted by me or by my designee under my direct supervision. The as-built plan accurately reflects site conditions.

Name (printed)

Signature

Date

Qualification

As-Built Certification for Completed Stormwater Management Devices – Sand Filter

Site Name
Address
Engineer

Consent Number
Date

The following information must be completed and submitted with the As-Built drawing of the stormwater management sand filter.

Stormwater Management Sand Filter As-Built Items to be included in the As-Built Plan submission as required.

It is necessary that photographic evidence be submitted to document stages of construction. Where large boxes are provided, please place an image or submit pictures of that stage to verify that construction was undertaken according to the plan.

- | | | | |
|--|---------------------------------|--------------------------------|--|
| 1. Were the dimensions of the sand filter (length, width and depth) as detailed on the approved plans sized appropriately in the field? For a prefabricated unit, is the unit sized to approved plans? | Yes
<input type="checkbox"/> | No
<input type="checkbox"/> | Insert a photograph of the foundation area of the sand filter prior to placement of the filter |
| 2. Was the foundation area compacted to meet minimum specifications? | Yes
<input type="checkbox"/> | No
<input type="checkbox"/> | |
| 3. Are the underdrains sized and placed correctly to the correct grade? | Yes
<input type="checkbox"/> | No
<input type="checkbox"/> | Provide a photograph showing the underdrains |
| 4. Does the filter media meet design specification? | Yes
<input type="checkbox"/> | No
<input type="checkbox"/> | |

- | | | |
|---|---------------------------------|--------------------------------|
| 5. Are all joints and pipe connections sealed and joined properly? | Yes
<input type="checkbox"/> | No
<input type="checkbox"/> |
| 6. Inflow and overflow systems installed correctly? | Yes
<input type="checkbox"/> | No
<input type="checkbox"/> |
| 7. Verify locations and locate on as-built plans all utilities that may impact on future maintenance. | Yes
<input type="checkbox"/> | No
<input type="checkbox"/> |
| 8. Constructed related sediments removed? | Yes
<input type="checkbox"/> | No
<input type="checkbox"/> |

For all those items listed above where "No" has been marked, please provide a discussion of the variation of those items from the consented design and why they are at variance. It is also requested that you state that the exceptions to the approved design do not adversely affect the intended performance or safety of the sand filter. If you cannot state that there is no adverse effect, you must also note to that effect.

The exceptions to the approved design do not adversely affect the intended performance or safety of the sand filter.

I certify that this stormwater management sand filter is constructed according to the consented design. This statement has been based upon on-site observation of the sand filter conducted by me or by my designee under my direct supervision. The as-built plan accurately reflects site conditions.

Name (printed)

Signature

Date

Qualification

As-Built Certification for Completed Stormwater Management Devices – Rain Garden

Site Name
Address
Engineer

Consent Number
Date

The following information must be completed and submitted with the As-Built drawing of the stormwater management rain garden. If there are multiple rain gardens, one form can be used but the individual rain gardens should be numbered on the plans so that reference to them in comments can be related to the specific one in the field.

Stormwater Management Rain Garden As-Built Items to be included in the As-Built Plan submission as required.

It is necessary that photographic evidence be submitted to document stages of construction. Where large boxes are provided, please place an image or submit pictures of that stage to verify that construction was undertaken according to the plan.

- | | | | |
|---|---------------------------------|--------------------------------|--------------------------------|
| 1. Were the dimensions of the rain garden (length, width and depth) as detailed on the approved plans constructed in the field? | Yes
<input type="checkbox"/> | No
<input type="checkbox"/> | |
| 2. Was a liner placed as required? | Yes
<input type="checkbox"/> | No
<input type="checkbox"/> | |
| 3. Perforated underdrain installed correctly according to standard engineering principles? | Yes
<input type="checkbox"/> | No
<input type="checkbox"/> | NA
<input type="checkbox"/> |
| 4. Storm drain system installed and connected? | Yes
<input type="checkbox"/> | No
<input type="checkbox"/> | |
- Insert picture of liner placement in excavation
- Insert picture of underdrain placement

5. Gravel, sand and planting media backfilled correctly and meets compaction specifications?

Yes

No

Insert a photograph showing the planting media prior to placement in the excavation area

6. Inflow and overflow systems installed according to design?

Yes

No

7. Vegetation complies with planting specifications?

Yes

No

8. Groundcover or mulch laid to specification?

Yes

No

9. Verify locations and locate on as-built plans all utilities that may impact on future maintenance.

Yes

No

10. Catchment contributing to rain garden stabilised?

Yes

No

11. Constructed related sediments removed?

Yes

No

12. Has access for maintenance been provided?

Yes

No

13. Rain garden completed according to plan?

Yes

No



For all those items listed above where “No” has been marked, please provide a discussion of the variation of those items from the consented design and why they are at variance. It is also requested that you state that the exceptions to the approved design do not adversely affect the intended performance or safety of the rain garden. If you cannot state that there is no adverse effect, you must also note to that effect.

The exceptions to the approved design do not adversely affect the intended performance of the rain garden.

I certify that this stormwater management rain garden is constructed according to the consented design. This statement has been based upon on-site observation of the rain garden conducted by me or by my designee under my direct supervision. The as-built plan accurately reflects site conditions.

Name (printed)

Signature

Date

Qualification

As-Built Certification for Completed Stormwater Management Devices – Infiltration Trench

Site Name
Address
Engineer

Consent Number
Date

The following information must be completed and submitted with the As-Built drawing of the stormwater management drywell or infiltration trench.

Stormwater Management Dry Well or Infiltration Trench As-Built Items to be included in the As-Built Plan submission as required.

It is necessary that photographic evidence be submitted to document stages of construction. Where large boxes are provided, please place an image or submit pictures of that stage to verify that construction was undertaken according to the plan.

1. Is the size and location of the infiltration trench according to the approved plans? Yes No

2. Was filter fabric placed on the bottom and sides of the trench according to the approved plans? Yes No

3. Are the aggregate materials sized according to the approved plans?

Yes No

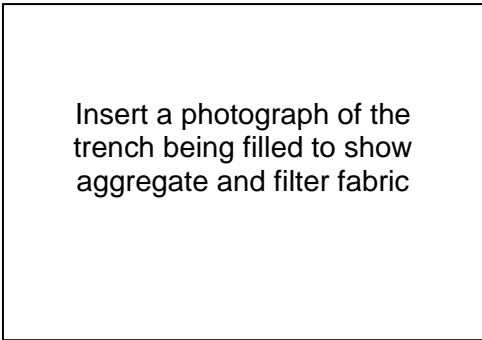

4. Has an observation well been installed? Yes No

5. Does the aggregate filter course meet size specifications and is clean, washed stone? Yes No

6. Has the porous surface material been placed properly?

Yes

No

7. Verify locations and locate on as-built plans (all utilities that may impact on future maintenance).

Yes

No

Insert a photograph to show the completed infiltration trench

For all those items listed above where "No" has been marked, please provide a discussion of the variation of those items from the consented design and why they are at variance. It is also requested that you state that the exceptions to the approved design do not adversely affect the intended performance or safety of the dry well or infiltration trench. If you cannot state that there is no adverse effect, you must also note to that effect.

The exceptions to the approved design do not adversely affect the intended performance or safety of the infiltration trench.

I certify that this stormwater management infiltration trench is constructed according to the consented design. This statement has been based upon on-site observation of the dry well or infiltration trench conducted by me or by my designee under my direct supervision. The as-built plan accurately reflects site conditions.

Name (printed)

Signature

Date

Qualification

As-Built Certification for Completed Stormwater Management Devices – Stormwater Management Pond or Wetland

Site Name
Address
Engineer

Consent Number
Date

The following information must be completed and submitted with the As-Built drawing of the stormwater management pond.

Stormwater Management Pond or Wetland As-Built Items to be included in the As-Built Plan submission as required.

It is necessary that photographic evidence be submitted to document stages of construction. Where large boxes are provided, please place an image or submit pictures of that stage to verify that construction was undertaken according to the plan.

1. All pipes, their sizing and associated structures are those specified on design drawings? Yes No

2. Cut-off trench excavated a minimum of 1 metre below sub-grade and minimum of 1 metre below proposed pipe invert, with side slopes no steeper than 1:1?

Yes No

Insert picture of cut-off trench here

3. Pipe placement undertaken according to sound engineering practices and uses water tight connections when pipes are joined? Yes No

4. Anti-seep collars or other seepage device properly spaced, with water tight connections to pipe and installed properly?

Yes No

Insert picture of anti-seep collars or here

5. Embankment properly compacted around pipe and fill placed in maximum 200 mm lifts?

Yes No

Insert picture of embankment during construction

6. Riser base set to design elevation?

Yes No

7. Principal spillway meets design specifications specifications and elevations?

Yes No

8. Pond toe drain installed correctly according to standard engineering principles?

Yes No

Insert picture of pond or wetland toe drain here

9. Impounded area meets design contours and side slopes? This includes any benches both above and below the permanent pool elevation.

Yes No

10. Forebay is constructed according to design plans, meeting depth and area requirements with appropriate energy dissipation?

Yes No

Insert picture of forebay clearly showing configuration and any energy dissipation

11. Emergency spillway is excavated to proper cross-section, side slopes and bottom width and armoured according to the design plans?

Yes No

The exceptions to the approved design do not adversely affect the intended performance or safety of the pond.

I certify that this stormwater management pond is constructed according to the consented design. This statement has been based upon on-site observation of the pond conducted by me or by my designee under my direct supervision. The as-built plan accurately reflects site conditions.

_____	_____
Name (printed)	Signature
_____	_____
Date	Qualification

Operation and maintenance forms

Operation and maintenance forms are provided for the following devices:

- Swales and filter strips
- Sand filters
- Rain gardens
- Infiltration trenches
- Ponds and wetlands
- Oil/water separators

	STORMWATER MAINTENANCE INSPECTION FORM				Inspector:			
					Date:			
					Time:			
					Weather: Rainfall over previous 2-3 days?			
					Page 1 of 2			
File No:								
Site Name:	ID No:							
Location	Catchment:							
			Needs immediate attention					
			Not Applicable					
SWALE AND FILTER STRIP PRACTICE MAINTENANCE INSPECTION CHECKLIST			<input checked="" type="checkbox"/> Required Y / N	<input checked="" type="checkbox"/> Okay	<input type="checkbox"/> ? Clarification Required			
"As built"	Required Y / N	Available Y / N	Adequate Y / N	Approx. check to verify vol(s). Y / N				
"Operation & Maintenance Plan"	Required Y / N	Available Y / N	Adequate Y / N					
"Planting Plan"	Required Y / N	Available Y / N	Adequate Y / N					
Swale And Filter Strip Components:								
Items Inspected	Checked		Maintenance Needed	Inspection Frequency	Checked		Maintenance Needed	Inspection Frequency
DEBRIS CLEANOUT	Y		Y N	M	CHECK DAMS / ENERGY DISSIPATORS / SUMPS		Y N	A
1. Swales and filter strips and contributing areas clean of debris								
2. No dumping of wastes into swales or filter strips								
3. Litter (branches, etc) have been removed								
VEGETATION				M				
4. Plant height not less than design water depth								
5. Fertilised per specifications								
6. No evidence of erosion								
7. Grass height not greater than 250mm								
8. Is plant composition according to design plans								
9. No placement of inappropriate plants								
DEWATERING				M				
10. Swales and filter strips dewater between storms								
11. No evidence of standing water								

Inspection Frequency Key A = Annual, M = Monthly

	STORMWATER MAINTENANCE INSPECTION FORM		Inspecting individual:
			Date:
			Time:
			Weather: Rainfall over previous 2-3 days?
			Page 1 of 2
			File No:

Site Name:	ID No:
Location	Catchment:
	Needs immediate attention Not Applicable

SWALE AND FILTER STRIP PRACTICE MAINTENANCE INSPECTION CHECKLIST		<input checked="" type="checkbox"/>	Required Y / N	<input checked="" type="checkbox"/>	Okay	<input type="checkbox"/>	Clarification Required
"As built"	Required Y / N	-	Available Y / N	Adequate Y / N	Approx. check to verify vol(s). Y / N		
"Operation & Maintenance Plan"	Required Y / N		Available Y / N	Adequate Y / N			
"Planting Plan"	Required Y / N		Available Y / N	Adequate Y / N			

Swale And Filter Strip Components:

Items Inspected	Checked		N		Inspection Frequency		Checked		Maintenance Needed		Inspection Frequency
	Y		Y	N			Y	N	Y	N	
DEBRIS CLEANOUT	Y		Y	N	M	CHECK DAMS / ENERGY DISSIPATORS / SUMPS	Y	N	Y	N	A
1. Swales and filter strips and contributing areas clean of debris											
2. No dumping of yard wastes into swales or filter strips											
3. Litter (branches, etc) have been removed											
VEGETATION					M						
4. Plant height not less than design water depth											
5. Fertilised per specifications											
6. No evidence of erosion											
7. Grass height not greater than 250mm											
8. Is plant composition according to design plans											
9. No placement of inappropriate plants											
DEWATERING					M						
10. Swales and filter strips dewater between storms											
11. No evidence of standing water											

Inspection Frequency Key A = Annual, M = Monthly



STORMWATER MAINTENANCE INSPECTION FORM

Inspector: _____
 Date: _____
 Time: _____
 Weather: Rainfall over previous 2-3 days? _____

 Page 1 of 2

Site Name: _____ File No: _____
 Location: _____ Consent No: _____
 Catchment: _____

RAIN GARDEN MAINTENANCE INSPECTION CHECKLIST	✘	Needs immediate attention	✔	Okay	?	Clarification Required
	-	Not Applicable				

"As built"	Required Y / N	Available Y / N	Adequate Y / N	Approx. check to verify vol(s). Y / N
"Operation & Maintenance Plan"	Required Y / N	Available Y / N	Adequate Y / N	
"Planting Plan"	Required Y / N	Available Y / N	Adequate Y / N	

Rain Garden Components:											
Items Inspected	Checked		Maintenance Needed		Inspection Frequency	OUTLETS/OVERFLOW SPILLWAY	Checked		Maintenance Needed		Inspection Frequency
	Y	N	Y	N	M		Y	N	Y	N	A, AMS
DEBRIS CLEANOUT					M	OUTLETS/OVERFLOW SPILLWAY					A, AMS
1. Rain gardens and contributing areas clean of debris						13. Good condition, no need for repair					
2. No dumping of yard wastes into rain garden						14. No evidence of erosion					
3. Litter (branches, etc) have been removed						15. No evidence of any blockages					
VEGETATION					3M	INTEGRITY OF BIOFILTER					A
4. Planting height not less than design water depth						16. Rain garden has not been blocked or filled inappropriately					
5. Fertilised per specifications						17. Mulch layer still in place					
6. No evidence of erosion						18. Noxious plants or weeds removed					
7. Is plant composition still according to approved plans											
8. No placement of inappropriate plants											
DEWATERING AND SEDIMENTATION											
9. Rain garden dewater between storms					3M						
10. No evidence of standing water											
11. No evidence of surface clogging											
12. Sediments should not be > than 20% of rain garden design depth											

Inspection Frequency Key A = Annual, M = Monthly, AMS = After Major Storm



STORMWATER MAINTENANCE INSPECTION FORM

Inspector: _____
 Date: _____
 Time: _____
 Weather: Rainfall over previous 2-3 days? _____

Page 1 of 2

Site Name: _____ File No: _____
 Location: _____ Consent No: _____
 Catchment: _____

INFILTRATION TRENCH MAINTENANCE INSPECTION CHECKLIST	X	Needs immediate attention	✓	Okay	?	Clarification Required
	-	Not Applicable				
"As built"	Required Y / N	Available Y / N	Adequate Y / N	Approx. check to verify vol(s). Y / N		
"Operation & Maintenance Plan"	Required Y / N	Available Y / N	Adequate Y / N			
"Planting Plan"	Required Y / N	Available Y / N	Adequate Y / N			

Infiltration Trench Components:

Items Inspected	Checked		Maintenance Needed		Inspection Frequency		Checked		Maintenance Needed		Inspection Frequency
	Y	N	Y	N			Y	N	Y	N	
DEBRIS CLEANOUT					M	INLETS					A
1. Trench surface clear of debris						13. Good condition					
2. Inlet areas clear of debris						14. No evidence of erosion					
3. Inflow pipes clear of debris						OUTLETS/OVERFLOW SPILLWAY					A
4. Overflow spillway clear of debris						15. Good condition, no need for repair					
SEDIMENT TRAPS, FOREBAYS, OR PRETREATMENT SWALES					A	16. No evidence of erosion					
5. Obviously trapping sediment						AGGREGATE REPAIRS					A
6. Greater than 50% of storage volume remaining						17. Surface of aggregate clean					
VEGETATION					M	18. Top layer of stone does not need replacement					
7. Mowing done when needed						19. Trench does not need rehabilitation					
8. Fertilized per specifications						VEGETATED SURFACE					M
9. No evidence of erosion						20. No evidence of erosion					
DEWATERING					3M	21. Perforated inlet functioning adequately					
10. Trench dewateres between storms						22. Water does not stand on vegetative surface					
SEDIMENT CLEANOUT OF TRENCH					A	23. Good vegetative cover exists					
11. No evidence of sedimentation in trench											
12. Sediment accumulation does not yet require cleanout											

Inspection Frequency Key A = Annual, M = Monthly



STORMWATER MAINTENANCE INSPECTION FORM

Inspector: _____
 Date: _____
 Time: _____
 Weather: Rainfall over previous 2-3 days? _____

Page 1 of 2

Site Name: _____ File No: _____
 Location: _____ Consent No: _____
 Catchment: _____

STORMWATER POND/WETLAND MAINTENANCE INSPECTION CHECKLIST	X	Needs immediate attention	✓	Okay	?	Clarification Required
	-	Not Applicable				
"As built"	Required Y / N	Available Y / N	Adequate Y / N	Approx. check to verify vol(s). Y / N		
"Operation & Maintenance Plan"	Required Y / N	Available Y / N	Adequate Y / N			
"Planting Plan"	Required Y / N	Available Y / N	Adequate Y / N			

Pond/Wetland Components:

Items Inspected	Checked		Maintenance Needed		Inspection Frequency	Checked		Maintenance Needed		Inspection Frequency
	Y	N	Y	N		Y	N	Y	N	
EMBANKMENT & EMERGENCY SPILLWAY					A,S					
1. Is the spillway level?					20. Concrete/Masonry condition					
2. Adequate vegetation & ground cover?					Riser and barrels:					
3. Appropriate plants / weeds?					a) Cracks or displacement?					
4. Adequate freeboard?					b) Minor spalling (<0.25mm)?					
5. Embankment erosion evident?					c) Major spalling (rebars exposed)?					
6. Cracking, bulging or sliding of dam					d) Joint failures?					
a) Upstream embankment					e) Water tightness adequate?					
b) Downstream embankment					21. Pond drain valve:					
c) At or beyond toe upstream					a) Operational / exercised?					
d) At or beyond toe downstream					b) Chained and locked?					
e) Emergency spillway					22. Slope protection or rip-rap failures?					
7. Pond & toe drains clear & functioning?					23. Other?					
8. Evidence of animal burrows?					PERMANENT POOL (WET POND)					3M
9. Seeps/leaks on downstream face?					24. Undesirable vegetative growth?					
10. Vertical & horizontal alignment of top of dam as per As-Built plans?					25. Removal of floating debris required?					
11. Emergency spillway clear of obstructions & debris					26. Visible pollution?					
12. Provision of access for maintenance?					27. Evidence of 'edge' erosion?					
a) By hand?					28. Other?					
b) For machinery?					DRY POND					3M
13. Other?					29. Adequate vegetation cover?					
RISER & SERVICE SPILLWAY					30. Presence of undesirable vegetation / woody growth?					
Type: Reinforced concrete					31. Standing water or wet spots?					
Metal pipe					32. Sediment and/or trash accumulation?					
Masonry					33. Low flow channels unobstructed?					
14. Low flow orifice obstructed?					34. Other?					
15. Low flow trash rack:					SEDIMENT FOREBAYS					
a) Is debris removal necessary?					35. Is sediment accumulation > 50% (maintenance req'd immed. if Yes)					
b) Is corrosion evident?					36. Provision of access for maintenance:					
16. Weir trash rack maintenance:					a) By hand?					
a) Is debris removal required?					b) For machinery?					
b) Is corrosion evident?					OUTFALLS INTO PONDS					A,S
17. Is there excessive sediment accumulation inside the riser?					37. Riprap failures?					
18. Metal pipe condition	Good		Fair		38. Condition of endwalls / headwalls	Good		Fair		Poor
19. Outfall channels functioning?					39. Evidence of slope erosion?					
					40. Condition of any inflow pipes.	Good		Fair		Poor
					41. Other?					

Items Inspected	Checked		Maintenance Needed		Inspection Frequency	Checked		Maintenance Needed		Inspection Frequency
	Y	N	Y	N		Y	N	Y	N	
OTHER					6M					A
					CONSTRUCTED WETLAND AREAS					



STORMWATER MAINTENANCE INSPECTION FORM

Inspector:
Date:
Time:
Weather: Rainfall over previous 2-3 days?
Page 1 of 2

Site Name:		File No:	
Location:		Consent No:	
		Catchment:	

OIL/WATER OPERATION & MAINTENANCE INSPECTION CHECKLIST	X	Needs immediate attention	✓	Okay	?	Clarification Required
	-	Not Applicable				
"As built"	Required Y / N	Available Y / N	Adequate Y / N	Approx. check to verify vol(s). Y / N		
"Operation & Maintenance Plan"	Required Y / N	Available Y / N	Adequate Y / N			
"Planting Plan"	Required Y / N	Available Y / N	Adequate Y / N			

API Components:											
Items Inspected	Checked		Maintenance Needed		Inspection Frequency					Inspection Frequency	
	Y	N	Y	N		Y	N	Y	N		
DEBRIS CLEANOUT					M					A	
1. Contributing areas clean of debris						STRUCTURAL COMPONENTS					A
2. API clean of debris						8. No evidence of structural deterioration					
3. Inlets and outlets clear of debris						9. Any grates are in good condition					
OIL AND SLUDGE					M	10. No evidence of spalling or cracking of structural parts					
4. Oil layer does not exceed 3 mm depth						OUTLETS / OVERFLOW SPILLWAY					A
5. Sludge deposits do not exceed 150 mm						11. Good condition, no need for repair					
WATER RETENTION					6M	12. No evidence of erosion (if draining into a natural channel)					
6. Water holding at normal pool depth?						OVERALL FUNCTION OF API					A
7. No evidence of leakage						13. No evidence of flow bypassing facility					
						14. No noticeable odours outside API					

Inspection Frequency Key A = Annual, M = Monthly

Warning: APIs have watertight covers; be careful regarding the possibility of flammable gases within them. Care should be taken lighting a match or smoking while inspecting practices that are not vented.

Inspector's signature: _____

