

Waikato River water quality monitoring programme: data report 2016

Prepared by:
Asaeli Tulagi

For:
Waikato Regional Council
Private Bag 3038
Waikato Mail Centre
HAMILTON 3240

July 2017

Document #: 10492663

Peer reviewed by:
Dr Eloise Ryan

Date July 2017

Approved for release by:
Dr Edmund Brown

Date August 2017

Disclaimer

This technical report has been prepared for the use of Waikato Regional Council as a reference document and as such does not constitute Council's policy.

Council requests that if excerpts or inferences are drawn from this document for further use by individuals or organisations, due care should be taken to ensure that the appropriate context has been preserved, and is accurately reflected and referenced in any subsequent spoken or written communication.

While Waikato Regional Council has exercised all reasonable skill and care in controlling the contents of this report, Council accepts no liability in contract, tort or otherwise, for any loss, damage, injury or expense (whether direct, indirect or consequential) arising out of the provision of this information or its use by you or any other party.

Acknowledgement

Thanks to Chris McKinnon, Ian Weir, Kane Lynn, Alicia Catlin, Mark Hamer, Jessie Loft, Trent Stokes, Stephen Scothern, Aaron Pedraza and Debbie Eastwood for their commitment and reliability in undertaking field measurements and sample collection.

Hydrological flow data were provided by Mercury Energy (Hydro Lakes, Waiotapu stream and Waikato River at Reids Farm), Contact Energy (Ohaaki Bridge) and Genesis Power (Huntly) through agents Opus and NIWA. The Environmental Monitoring Programme, Waikato Regional Council, Hamilton provided hydrological flow data for two sites.

Table of contents

1	Introduction	1
1.1	Background	1
1.2	Report content	1
1.3	Water quality guidelines and standards	2
2	The Waikato River monitoring programme design	3
2.1	Sampling collection	3
2.2	Sample locations	3
2.3	Water quality parameters	4
2.4	Quality control, data storage and analysis	5
2.5	Reports	5
3	Results	6
3.1	Waikato River monitoring programme	6
	Routine water quality monitoring	6
	Summary statistics	6
	Five yearly major ion statistics	6
	Key parameter graphs	6
	Comparison with water quality standards	6
	Raw data	6
3.2	Waikato River monitoring programme	28
	Bathing season microbiological survey	28
	Summary statistics	28
	Comparison with water quality standards	28
	Parameter graph	28
	Raw data	28
	References	32
	Appendix I:	33
	Flow information	33
	Appendix II	35
	Datasonde deployments	35
	Diurnal variation of selected water quality parameters	35
	Appendix III:	47
	Water quality parameters	47
	Guidelines and standards	47
	Analytical methods	47

Tables

Table 1:	Guidelines and standards for physicochemical water quality for ecological health and for human uses of water	2
Table 2:	Routine sampling and bathing water monitoring locations	4
Table 3:	Number of samples (year 2016) complying with the 'satisfactory' water quality guidelines and standards. n = 12 (except * where n = 11 & ^ where n=10).	20
Table 4:	Number of samples (year 2016) complying with the 'excellent' water quality guidelines and standards. n = 12 (except * where n = 11 & ^ where n=10).	20
Table 5:	Bathing season median E. coli bacteria.	29
Table 6:	Year 2016/17 bathing season E. coli survey results complying with the "Satisfactory" and "Excellent" water quality guidelines. n = 12 (except * where n = 13).	29

Figures

Figure 1:	Waikato River water quality monitoring locations	3
Figure 2:	E. coli - five years of bathing season data	30

1 Introduction

1.1 Background

This report covers the calendar year of 2016 and follows the format of the previous data report (Tulagi, 2016).

To effectively manage water quality, the Waikato River monitoring programme addresses the following questions:

1. What is the quality of the water now?
2. Why is the water of the observed level of quality?
3. Is water quality getting better or worse? If so - what makes it change?
4. How can we improve the quality, ecological health and integrity of the Waikato River?

The monitoring information allows the Council to:

- determine compliance with classification standards
- define the suitability of the resource for various beneficial uses and values of the water
- monitor the impact of major discrete point source discharges on water quality
- monitor the impacts of diffuse discharges on water quality
- provide a basis for evaluating the effectiveness of resource management measures.

This dataset is invaluable for the evaluation of the Waikato River: its state, the pressures on it and its response to these pressures. We need to continue to gather comprehensive, reliable, and good quality data on the Waikato River to protect and enhance its values into the future.

This report is the 26th since the re-design of the Waikato River Monitoring Programme (WARIMP) implemented in 1989. Copies of reports can be obtained via the Waikato Regional Council Internet site <http://www.waikatoregion.govt.nz/Publications/> or by contacting Waikato Regional Council (the Library) on 0800 800 401 and filling out the request for service form at: www.waikatoregion.govt.nz/request.

1.2 Report content

The report provides information on:

1. Routine monthly monitoring of water quality at 10 sites:
 - Year 2016 summary data tabulated by parameter for each location and reported with the median of the previous 5 years.
 - Key parameter graphs showing the average water quality for 2016 at each location, compared to results of the previous 5 years.
 - Summary tables identifying the number of samples meeting 'satisfactory' and 'excellent' water quality standards and guidelines.
 - Raw data for 2016.
2. Additional information is provided in the appendices on:
 - Flow (*Appendix I*).
 - The effect of flow is important to assessing water quality and making comparisons between years. Appendix I provides information on annual median flow at some locations for the previous 10 years.
 - Datasonde deployments
 - Plots of deployments undertaken during 2016 showing the level of diurnal and seasonal variation at five Waikato River sites (*Appendix II*).

1.3 Water quality guidelines and standards

Table 1 lists the physical and chemical water quality standards and guidelines used to assess the condition of the Waikato River in 2016. The standards mainly relate to either the protection of ecological health of rivers and streams or to whether they are suitable for water-based recreation, especially swimming.

Some water quality guidelines and standards are relevant to the use of the Waikato River for both general water supply (industrial/cooling water, irrigation, stock water etc.) and as a source of municipal drinking water. In most cases two criteria are shown. The less stringent criteria define water that is “satisfactory” for the desired use; these are mostly based on existing national and other guidelines and standards (Appendix III). The more stringent criteria identify “excellent” water, and reflect expert opinion. Samples gathered in 2016 whose results do not comply with the “satisfactory” criteria (Table 1) are underlined in raw data summaries.

Table 1: Guidelines and standards for physicochemical water quality for ecological health and for human uses of water

Water Quality Measure	Relevance ¹	Satisfactory	Excellent
Ecological health			
Dissolved oxygen (% saturation)	aquatic life (breathing)	>80	>90
pH	aquatic life (acidity)	6.5–9	7–8
Turbidity (NTU)	plant growth (clarity)	<5	<2
Ammoniacal-N (g/m ³)	aquatic life (toxicity)	<0.88	<0.1
Temperature (°C)	fish (spawning)	<12 <20	<10 <16
Total phosphorus (g/m ³)	nuisance plant growth	<0.04	<0.01
Total nitrogen (g/m ³)	nuisance plant growth	<0.5	<0.1
Human uses - recreation			
Baseflow water clarity (m)	visibility	>1.6	>4
Escherichia coli (no./100 mL)	human health	<550	<55
Median Escherichia coli (no./100 mL)	human health	<126	<23
Human uses - water supply			
Phytoplankton chlorophyll <i>a</i> (g/m ³)	filter blockage	<0.02	<0.005
Human uses - drinking water			
Arsenic (g/m ³)	human health (toxicity)	<0.01	–
Boron (g/m ³)	human health (toxicity)	<1.4	–

¹ Refer to Appendix III for description of guideline and standards values used. These guidelines and standards are also defined on the Waikato Regional Council Internet site; www.waikatoregion.govt.nz

2 The Waikato River monitoring programme design

2.1 Sampling collection

Sample collection occurs monthly, as two sampling runs. Locations in the upper catchment from Taupo to Waipapa are visited as part of the first run, and locations in the middle and lower catchments from Hamilton (at the Narrows) to Tuakau are visited on the next. Each location is sampled at a similar time on each occasion (coefficient of variation $\approx 2\text{--}6\%$) to minimise the effect of diurnal variation on the measurement of water quality parameters. Sample times are recorded in New Zealand Standard Time (NZST). Because of the controlled nature of the river, our daytime samples are generally collected at higher than median flows.

2.2 Sample locations

Routine water quality monitoring locations of the Waikato River Monitoring Programme and additional locations used during the summer microbiological surveys are illustrated in *Figure 1* and summarised in *Table 2*.

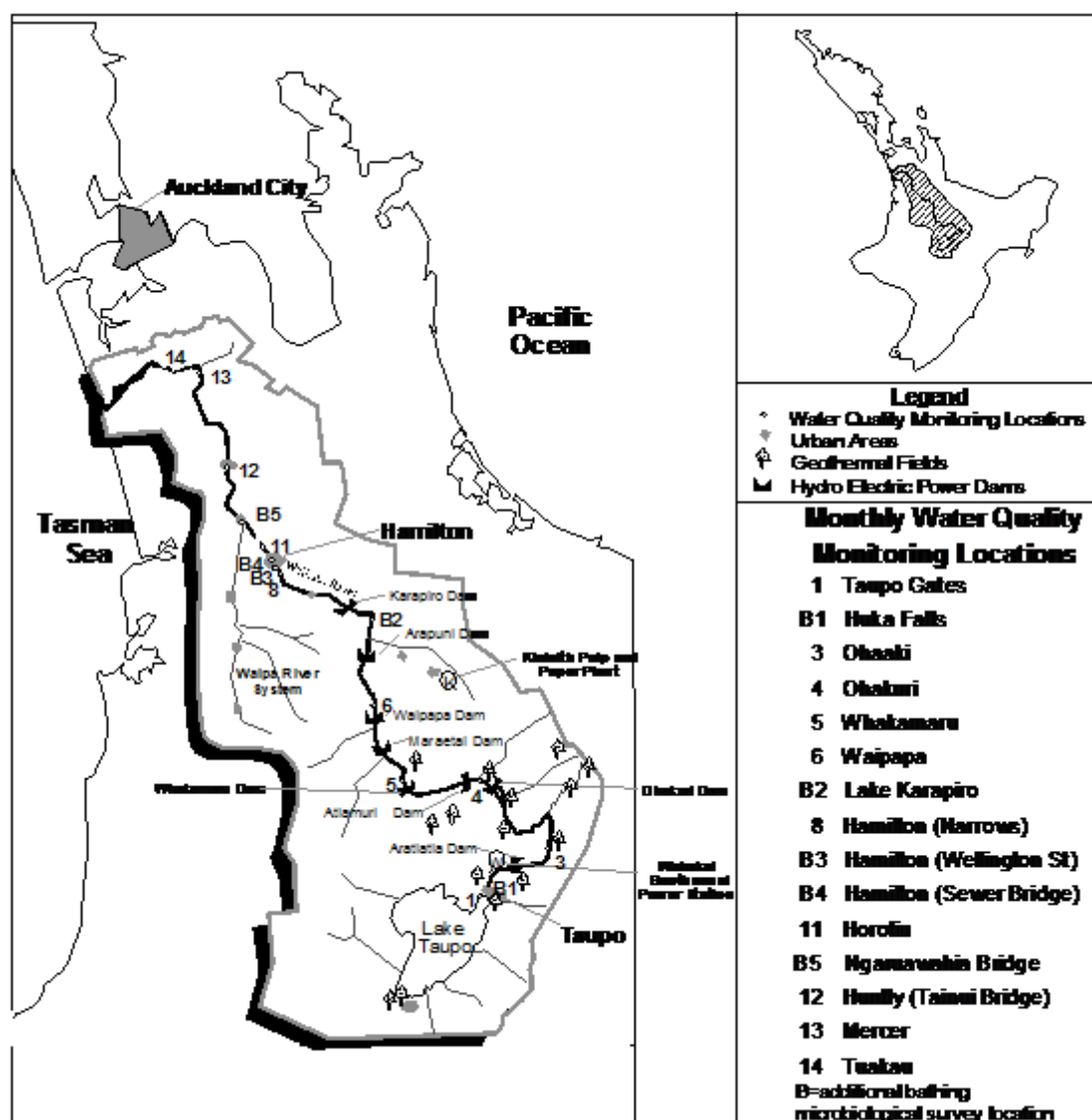

Figure 1: Waikato River water quality monitoring locations

Ten locations along the river are visited monthly (Taupo, Ohaaki, Ohakuri, Whakamaru, Waipapa, Hamilton-Narrows, Hamilton-Horotiu, Huntly, Mercer and Tuakau), and an additional four locations are included for the summer intensive microbiological survey (see Table 2, Figure 1). The major tributaries that enter the Waikato River are also monitored monthly as part of the Regional River Monitoring Programme (RERIMP) initiated in 1993 (Huser and Wilson, 1996b). Three locations (Taupo at Reids Farm, Hamilton at Wellington Street, and Rangiriri) are sampled by NIWA as part of the 'National River Water Quality Network' (Table 2).

Table 2: Routine sampling and bathing water monitoring locations

Location Number	Distance ¹ (km)	Location name	Map Ref.	Field [†] Measurements
1131.127	0.1	Taupo Gates	U18:772-757	–
1131.649 ^{*d}	2.0	Taupo Bungy	U18:785:758	at jetty, true right bank
1131.70 ^b	6.0	Huka Falls	U18:789-792	–
1131.219 ^d	8.4	Downstream Huka Falls	U17:802-813	river boat jetty ²
1131.105 ^d	36.5	Ohaaki Bridge	U17:981-914	at bridge, true right bank
1131.107	75.8	Ohakuri Tailrace Bridge	U17:796-061	boat ramp ³
1131.147	105.0	Whakamaru Tailrace	T17:552-056	boat ramp ⁴
1131.143	126.1	Waipapa Tailrace	T16:448-200	boat ramp ⁵
1131.81 ^b	166.7	Lake Karapiro Boat Ramp	T15:436-570	Horahora domain
1131.328	202.2	Hamilton – Narrows	S14:168-710	boat ramp ⁶
1131.145 ^{*b}	210.8	Hamilton – Wellington St Bch	S14:117-757	at jetty, true right bank
1131.64 ^d	211.5	Hamilton – Traffic Bridge	S14:118-764	true right bank
1131.121 ^b	219.8	Hamilton – Sewer Bridge	S14:082-823	true left bank
1131.69	225.6	Horotiu Bridge	S14:048-871	d/s of bridge
1131.102 ^b	232.3	Ngaruawahia Bridge	S14:997-912	u/s of confluence ⁷
1131.77	246.5	Huntly – Tainui Bridge	S13:003-018	true left bank
1131.117 ^{*d}	262.3	Rangiriri Bridge	S13:989-167	true right bank
1131.91	286.3	Mercer Bridge	S12:919-336	–
1131.133	296.8	Tuakau Bridge	R12:828-320	boat ramp ⁸
1131.131 ^d	306.5	Tuakau – Elbows Landing	R12:745-352	NZ Steel Ltd pumping station
792.1 ^b	337	Port Waikato – Maraetai Bay	R13:630-223	at dune beach

¹ approximate distance (in kilometres) from Lake Taupo's outlet.

² river boat jetty and boat ramp, true left bank, about 1.8 km downstream of Huka Falls

³ boat ramp in recreation reserve immediately upstream from dam (true left bank).

⁴ boat ramp at Whakamaru Power Station.

⁵ river access d/s of Lake Waipapa, about 500 m off S.H. 32 along a gravel road (true left bank).

⁶ boat ramp accessed via Narrows Lane (true right bank)

⁷ road bridge upstream of Waipa River confluence.

⁸ immediately d/s of bridge, at Reserve (true right bank).

^b bathing season intensive microbiological survey locations only – survey conducted over the 2014/15 summer.

^{*} locations at **Taupo (Taupo Bungy, 2 km d/s from Taupo Gates)**, at **Hamilton (Wellington Street jetty)** and at **Rangiriri (Rangiriri Bridge)** are sampled and reported as part of the National River Water Quality Network undertaken by NIWA. Contact person: Graham Bryers, NIWA, Hamilton.

[†] logistic considerations mean field measurements are often made at slightly different locations from sample collection (e.g. sampling from bridges).

^d datasonde deployment sites.

2.3 Water quality parameters

Water quality of the Waikato River is assessed by measuring up to 40 parameters (27 routinely). Some parameters are measured in the field, but the majority of parameters are analysed in a

laboratory using standard analytical methods. Details of field measurements and analytical methods used are appended (*Appendix III*).

2.4 Quality control, data storage and analysis

Quality control measures are undertaken in accordance with Waikato Regional Council's standards including procedures for the collection, transport, storage of samples, and methods for data verification and quality assurance to ensure the consistency of data across the programme. Samples are sent to IANZ registered laboratories for analysis. Back-up samples are held for two months until results have been verified by routine quality assurance procedures. All data from field measurements and laboratory analyses are stored in Waikato Regional Council's database called WISKI.

Data analysis was performed using Statistica (version 13.0) and DataDesk (version 6.0.1). For the purpose of data analysis, non-detect results (i.e. results with "less than" values) were assumed to be equal to half the corresponding limit of detection (i.e. $<x = x/2$), and results greater than the value reported were taken as equal to the value reported (i.e. $>x = x$).

2.5 Reports

Waikato Regional Council's State of the Environment Report summarises the state of the Waikato River, other rivers in the region, and common pressures (Environment Waikato, 1999).

Waikato Regional Council Technical Report 2013/20, Trends in River Water Quality in the Waikato Region, 1993–2012 (Vant, 2013) outlines the trends in the Waikato River and other rivers in the region. Copies are available in electronic format from the publications page of the Waikato Regional Council website:

<http://www.waikatoregion.govt.nz/Publications/Technical-Reports>

The data contained in these Waikato River reports is updated to the Waikato Regional Council "Waikato River" Internet page:

<http://www.waikatoregion.govt.nz/Fresh-water-quality>

The "How healthy are our rivers?" link provides details of the guidelines and standards used to assess the condition of the Waikato River and other rivers in the region. A link to water quality at other regional river monitoring sites is also available from this page.

This data is also supplied to the LAWA website <https://www.lawa.org.nz/explore-data/waikato-region>

3 Results

3.1 Waikato River monitoring programme

Routine water quality monitoring

Summary statistics

Five yearly major ion statistics

Key parameter graphs

Comparison with water quality standards

Raw data

Absorbance of filtered sample at 340 nm (units :/cm)								
Location	Count	Mean	Median	Min	Max	IQR	Skew	5 Yr Median
Taupo Control Gates	12	0.001	0.001	0.001	0.001	0.000	-1.00	0.001
Ohaaki Bridge	12	0.004	0.004	0.002	0.007	0.001	1.28	0.003
Ohakuri Tailrace Bridge	12	0.007	0.006	0.005	0.011	0.001	1.44	0.005
Whakamaru Tailrace	12	0.009	0.007	0.006	0.015	0.002	1.47	0.007
Waipapa Tailrace	12	0.011	0.010	0.008	0.017	0.003	1.20	0.010
Narrow s	12	0.015	0.012	0.010	0.026	0.004	1.30	0.012
Horotiu Bridge	12	0.014	0.012	0.010	0.026	0.005	1.44	0.012
Huntly-Tainui Bridge	12	0.022	0.019	0.014	0.050	0.008	1.59	0.019
Mercer Bridge	12	0.029	0.023	0.014	0.068	0.017	1.29	0.021
Tuakau Bridge	12	0.032	0.026	0.005	0.077	0.029	0.83	0.024

Absorbance of filtered sample at 440 nm (units :/cm)								
Location	Count	Mean	Median	Min	Max	IQR	Skew	5 Yr Median
Taupo Control Gates	12	0.001	0.001	0.001	0.001	0.000	-1.00	0.001
Ohaaki Bridge	12	0.001	0.001	0.001	0.003	0.000	<u>3.02</u>	0.001
Ohakuri Tailrace Bridge	12	0.001	0.001	0.001	0.002	0.000	<u>3.02</u>	0.001
Whakamaru Tailrace	12	0.001	0.001	0.001	0.003	0.001	1.43	0.001
Waipapa Tailrace	12	0.002	0.002	0.001	0.004	0.001	0.94	0.001
Narrow s	12	0.003	0.002	0.002	0.005	0.001	1.34	0.002
Horotiu Bridge	12	0.003	0.002	0.001	0.005	0.002	0.69	0.002
Huntly-Tainui Bridge	12	0.004	0.004	0.003	0.009	0.002	1.57	0.003
Mercer Bridge	12	0.005	0.005	0.001	0.012	0.003	1.04	0.004
Tuakau Bridge	12	0.006	0.005	0.001	0.014	0.005	0.76	0.004

Arsenic - Total (g/m ³)								
Location	Count	Mean	Median	Min	Max	IQR	Skew	5 Yr Median
Taupo Control Gates	12	0.012	0.012	0.011	0.013	0.001	-0.15	0.012
Ohaaki Bridge	12	0.023	0.024	0.019	0.031	0.005	0.82	0.025
Ohakuri Tailrace Bridge	12	0.029	0.030	0.023	0.035	0.004	-0.16	0.030
Whakamaru Tailrace	12	0.028	0.030	0.022	0.031	0.005	-0.78	0.029
Waipapa Tailrace	12	0.023	0.024	0.020	0.027	0.005	-0.18	0.025
Narrow s	12	0.021	0.022	0.016	0.026	0.005	-0.11	0.022
Horotiu Bridge	12	0.021	0.022	0.016	0.027	0.005	-0.06	0.022
Huntly-Tainui Bridge	12	0.016	0.016	0.008	0.023	0.009	-0.28	0.017
Mercer Bridge	12	0.015	0.015	0.009	0.021	0.009	-0.05	0.016
Tuakau Bridge	12	0.015	0.016	0.008	0.021	0.008	-0.24	0.016

Boron (g/m ³)								
Location	Count	Mean	Median	Min	Max	IQR	Skew	5 Yr Median
Taupo Control Gates	12	0.17	0.17	0.15	0.19	0.02	0.09	0.17
Ohaaki Bridge	12	0.29	0.28	0.24	0.37	0.07	0.75	0.28
Ohakuri Tailrace Bridge	12	0.32	0.32	0.25	0.37	0.03	-0.05	0.32
Whakamaru Tailrace	12	0.30	0.32	0.24	0.37	0.05	-0.10	0.32
Waipapa Tailrace	12	0.26	0.26	0.21	0.29	0.03	-0.52	0.28
Narrow s	12	0.22	0.22	0.19	0.28	0.05	0.56	0.25
Horotiu Bridge	12	0.23	0.24	0.18	0.28	0.05	-0.37	0.25
Huntly-Tainui Bridge	12	0.19	0.18	0.11	0.26	0.07	0.03	0.19
Mercer Bridge	12	0.18	0.19	0.12	0.24	0.06	-0.02	0.19
Tuakau Bridge	12	0.18	0.18	0.11	0.25	0.07	0.13	0.20

Skew = skewness. Underlined values = non-normal distribution. IQR = Inter Quartile Range

Black Disk (m)								
Location	Count	Mean	Median	Min	Max	IQR	Skew	5 Yr Median
Taupo Control Gates	-	-	-	-	-	-	-	-
Ohaaki Bridge	11.0	5.9	5.9	1.5	8.0	2.3	-0.97	4.5
Ohakuri Tailrace Bridge	11.0	2.5	2.4	1.3	3.7	1.4	-0.10	2.4
Whakamaru Tailrace	11.0	2.4	2.2	1.6	3.1	0.9	-0.05	2.2
Waipapa Tailrace	10.0	2.3	2.3	1.9	3.0	0.5	0.43	2.1
Narrow s	11.0	2.1	2.2	1.2	2.5	0.6	-0.90	1.8
Horotiu Bridge	11.0	1.7	1.8	0.8	2.6	0.6	-0.04	1.6
Huntly-Tainui Bridge	11.0	1.0	1.1	0.5	2.1	0.3	1.39	1.0
Mercer Bridge	-	-	-	-	-	-	-	-
Tuakau Bridge	11.0	0.8	0.7	0.2	1.6	0.6	0.61	0.7

Biochemical Oxygen Demand - 5 day (g/m ³)								
Location	Count	Mean	Median	Min	Max	IQR	Skew	5 Yr Median
Taupo Control Gates	12	0.9	0.75	0.2	1.5	0.85	0.07	0.7
Ohaaki Bridge	12	0.7	0.7	0.2	1.4	0.25	0.59	0.8
Ohakuri Tailrace Bridge	12	1.1	1.1	0.6	1.9	0.5	0.77	0.9
Whakamaru Tailrace	12	0.9	0.8	0.2	1.7	0.35	0.61	1.0
Waipapa Tailrace	12	0.8	0.8	0.5	1.1	0.2	-0.29	0.9
Narrow s	12	0.9	0.8	0.4	1.2	0.2	-0.40	1.0
Horotiu Bridge	12	0.9	0.9	0.6	1.2	0.25	0.05	1.0
Huntly-Tainui Bridge	12	1.2	1.3	0.7	2	0.45	0.45	1.2
Mercer Bridge	12	1.4	1.35	0.8	2.1	0.9	0.14	1.4
Tuakau Bridge	12	1.4	1.4	0.8	2.1	0.45	0.30	1.4

Carbon - Dissolved Organic (g/m ³)								
Location	Count	Mean	Median	Min	Max	IQR	Skew	5 Yr Median
Taupo Control Gates	12	1.2	1.0	0.8	2.2	0.8	1.0	1.0
Ohaaki Bridge	12	1.0	0.9	0.7	2.3	0.4	<u>1.9</u>	1.0
Ohakuri Tailrace Bridge	12	1.3	1.2	0.7	2.3	0.2	1.5	1.2
Whakamaru Tailrace	12	1.3	1.2	1.0	1.8	0.4	0.9	1.3
Waipapa Tailrace	12	1.4	1.3	1.0	1.8	0.3	0.5	1.3
Narrow s	12	1.5	1.4	1.0	2.2	0.5	0.7	1.6
Horotiu Bridge	12	1.7	1.6	1.2	3.4	0.4	<u>2.2</u>	1.6
Huntly-Tainui Bridge	12	2.2	2.1	1.5	4.2	0.5	1.5	1.9
Mercer Bridge	12	2.8	2.2	1.3	5.3	2.0	0.8	2.2
Tuakau Bridge	12	3.0	2.5	1.4	5.9	2.2	0.8	2.4

Carbon - Total Organic (g/m ³)								
Location	Count	Mean	Median	Min	Max	IQR	Skew	5 Yr Median
Taupo Control Gates	12	1.3	1.1	0.8	2.4	0.9	0.7	1.0
Ohaaki Bridge	12	1.2	1.0	0.8	2.7	0.3	<u>2.5</u>	1.1
Ohakuri Tailrace Bridge	12	1.5	1.2	1.0	2.5	0.8	1.0	1.3
Whakamaru Tailrace	12	1.5	1.6	1.1	2.3	0.5	0.6	1.5
Waipapa Tailrace	12	1.6	1.5	1.3	2.0	0.4	0.4	1.6
Narrow s	12	1.8	1.8	1.3	2.4	0.7	0.3	1.9
Horotiu Bridge	12	1.9	1.8	1.4	2.9	0.6	1.0	1.9
Huntly-Tainui Bridge	12	2.6	2.2	1.4	4.9	1.5	1.0	2.3
Mercer Bridge	12	3.3	2.9	1.6	6.3	2.1	0.7	2.9
Tuakau Bridge	12	3.6	3.5	1.7	7.0	2.4	0.7	3.2

Skew = skewness. Underlined values = non-normal distribution. IQR = Inter Quartile Range

Chloride (g/m ³)								
Location	Count	Mean	Median	Min	Max	IQR	Skew	5 Yr Median
Taupo Control Gates	12	8.1	8.2	7.7	8.6	0.3	0.08	8.2
Ohaaki Bridge	12	15.4	14.2	12.2	21.0	3.4	0.84	15.3
Ohakuri Tailrace Bridge	12	18.1	18.3	13.3	21.0	2.5	-0.67	18.7
Whakamaru Tailrace	12	17.9	17.5	14.1	21.0	3.4	-0.09	18.9
Waipapa Tailrace	12	16.6	16.4	14.0	18.8	2.6	-0.07	18.2
Narrow s	12	16.2	16.6	12.9	18.6	2.3	-0.48	17.0
Horotiu Bridge	12	16.4	16.7	13.1	18.8	2.5	-0.43	17.1
Huntly-Tainui Bridge	12	15.4	16.0	12.8	18.1	2.3	-0.27	15.8
Mercer Bridge	12	16.0	16.3	13.3	17.9	1.9	-0.54	16.6
Tuakau Bridge	12	16.2	16.8	13.5	18.0	1.6	-0.84	16.9

Chlorophyll a (g/m ³)								
Location	Count	Mean	Median	Min	Max	IQR	Skew	5 Yr Median
Taupo Control Gates	12	0.002	0.002	0.002	0.002	0.000	1.00	0.002
Ohaaki Bridge	12	0.002	0.002	0.002	0.002	0.000	1.00	0.002
Ohakuri Tailrace Bridge	12	0.006	0.006	0.002	0.020	0.005	<u>1.75</u>	0.004
Whakamaru Tailrace	12	0.010	0.008	0.002	0.023	0.010	0.74	0.006
Waipapa Tailrace	12	0.007	0.004	0.002	0.018	0.010	0.73	0.005
Narrow s	12	0.008	0.006	0.002	0.026	0.006	1.66	0.005
Horotiu Bridge	12	0.009	0.008	0.003	0.017	0.009	0.41	0.006
Huntly-Tainui Bridge	12	0.008	0.009	0.002	0.017	0.007	0.32	0.006
Mercer Bridge	12	0.014	0.013	0.002	0.037	0.015	0.76	0.009
Tuakau Bridge	12	0.016	0.015	0.002	0.045	0.017	0.90	0.010

Colour (Munsell Colour Units)								
Location	Count	Mean	Median	Min	Max	IQR	Skew	5 Yr Median
Taupo Control Gates	-	-	-	-	-	-	-	-
Ohaaki Bridge	11	51.4	55.0	40.0	65.0	10.0	0.17	50.0
Ohakuri Tailrace Bridge	11	38.2	37.5	32.5	45.0	4.4	0.25	40.0
Whakamaru Tailrace	10	36.3	37.5	32.5	40.0	5.0	-0.21	40.0
Waipapa Tailrace	11	35.0	35.0	32.5	40.0	4.4	0.63	37.5
Narrow s	11	34.3	35.0	30.0	40.0	2.5	0.18	37.5
Horotiu Bridge	11	33.4	32.5	30.0	37.5	2.5	0.02	35.0
Huntly-Tainui Bridge	11	30.5	30.0	25.0	40.0	5.0	0.77	32.5
Mercer Bridge	-	-	-	-	-	-	-	-
Tuakau Bridge	11	27.9	25.0	25.0	34.0	5.0	0.54	30.0

Conductivity at 25 °C (ms/m)								
Location	Count	Mean	Median	Min	Max	IQR	Skew	5 Yr Median
Taupo Control Gates	12	12.1	12.1	12.0	12.6	0.2	1.45	12.0
Ohaaki Bridge	12	15.1	14.8	13.8	17.3	1.2	0.86	14.9
Ohakuri Tailrace Bridge	12	16.7	16.7	14.5	17.9	1.1	-0.77	16.6
Whakamaru Tailrace	12	16.5	16.4	14.8	18.0	1.4	-0.02	16.7
Waipapa Tailrace	12	15.7	15.6	14.7	17.0	1.0	0.50	16.2
Narrow s	12	15.6	16.0	14.2	16.9	1.5	-0.19	15.9
Horotiu Bridge	12	15.6	15.7	14.3	16.9	1.3	0.06	16.0
Huntly-Tainui Bridge	12	15.0	14.8	12.8	16.8	1.6	-0.10	14.9
Mercer Bridge	12	15.5	15.4	14.0	16.9	1.4	0.05	15.6
Tuakau Bridge	12	15.6	15.7	14.1	16.9	1.4	-0.18	15.8

Skew = skewness. Underlined values = non-normal distribution. IQR = Inter Quartile Range

Dissolved Oxygen (g/m ³)								
Location	Count	Mean	Median	Min	Max	IQR	Skew	5 Yr Median
Taupo Control Gates	12	10.1	10.2	8.9	11.1	0.9	-0.32	9.9
Ohaaki Bridge	12	10.0	10.2	8.2	11.8	1.4	-0.10	9.8
Ohakuri Tailrace Bridge	12	10.0	9.7	8.9	11.5	1.9	0.34	9.7
Whakamaru Tailrace	12	10.1	9.8	8.7	11.8	1.6	0.27	9.9
Waipapa Tailrace	12	10.1	10.0	9.0	11.3	1.3	0.18	9.9
Narrow s	12	9.7	9.6	8.1	11.7	1.6	0.17	9.9
Horotiu Bridge	12	9.6	9.7	8.1	11.2	2.0	0.00	9.8
Huntly-Tainui Bridge	12	9.4	9.7	8.2	10.5	1.1	-0.29	9.6
Mercer Bridge	12	9.4	9.4	8.5	10.2	0.8	-0.10	9.5
Tuakau Bridge	12	9.3	9.2	8.6	11.0	0.8	1.42	9.5

Dissolved Oxygen (% Saturation)								
Location	Count	Mean	Median	Min	Max	IQR	Skew	5 Yr Median
Taupo Control Gates	12	103.5	103.7	95.5	110.6	8.4	-0.04	102.0
Ohaaki Bridge	12	104.2	103.9	96.6	110.8	3.8	-0.37	102.6
Ohakuri Tailrace Bridge	12	105.0	103.8	91.4	122.8	11.4	0.28	101.3
Whakamaru Tailrace	12	105.1	105.1	89.2	118.5	13.6	-0.17	103.6
Waipapa Tailrace	12	103.9	104.9	88.4	116.1	15.4	-0.22	101.4
Narrow s	12	98.2	97.3	91.0	114.7	7.4	1.25	97.5
Horotiu Bridge	12	97.2	95.7	91.2	110.3	9.9	0.88	96.7
Huntly-Tainui Bridge	12	96.2	95.6	91.2	105.4	5.9	0.80	95.7
Mercer Bridge	12	96.7	96.0	88.0	112.0	8.2	0.87	95.9
Tuakau Bridge	12	97.3	96.9	79.9	122.6	12.6	0.77	97.6

Enterococci (cfu/100 mL)								
Location	Count	Mean	Median	Min	Max	IQR	Skew	5 Yr Median
Taupo Control Gates	12	2	1	1	7	3	1.1	1
Ohaaki Bridge	12	19	6	1	59	38	0.8	7
Ohakuri Tailrace Bridge	12	6	3	1	25	8	<u>1.9</u>	2
Whakamaru Tailrace	12	79	10	1	590	77	<u>2.7</u>	5
Waipapa Tailrace	12	33	7	1	320	8	<u>3.0</u>	4
Narrow s	12	82	54	21	400	60	<u>2.6</u>	34
Horotiu Bridge	12	56	39	18	150	48	1.2	43
Huntly-Tainui Bridge	12	64	51	21	250	43	<u>2.3</u>	40
Mercer Bridge	12	37	33	7	120	39	1.5	24
Tuakau Bridge	12	46	40	7	160	27	1.6	22

Escherichia coli (cfu/100 mL)								
Location	Count	Mean	Median	Min	Max	IQR	Skew	5 Yr Median
Taupo Control Gates	12	4	3	1	10	5	0.8	2
Ohaaki Bridge	12	23	15	4	70	21	1.4	14
Ohakuri Tailrace Bridge	12	6	4	1	21	8	1.3	2
Whakamaru Tailrace	12	29	10	4	120	44	1.5	8
Waipapa Tailrace	12	11	9	1	25	15	0.6	5
Narrow s	12	67	50	19	200	62	1.5	38
Horotiu Bridge	12	105	80	19	250	80	1.0	80
Huntly-Tainui Bridge	12	258	95	30	1300	260	<u>2.2</u>	110
Mercer Bridge	12	218	65	50	1400	126	<u>2.7</u>	70
Tuakau Bridge	12	135	60	34	500	80	<u>1.7</u>	70

Skew = skewness. Underlined values = non-normal distribution. IQR = Inter Quartile Range

Faecal Coliforms (cfu/100 mL)								
Location	Count	Mean	Median	Min	Max	IQR	Skew	5 Yr Median
Taupo Control Gates	12	4	3	1	14	6	1.0	2
Ohaaki Bridge	12	30	18	4	80	28	1.0	14
Ohakuri Tailrace Bridge	12	7	5	1	21	9	1.1	3
Whakamaru Tailrace	12	35	11	4	130	61	1.1	8
Waipapa Tailrace	12	14	10	1	43	17	1.1	7
Narrow s	12	89	55	21	230	97	1.0	48
Horotiu Bridge	12	144	125	25	330	157	0.7	100
Huntly-Tainui Bridge	12	283	110	40	1300	310	<u>2.0</u>	120
Mercer Bridge	12	248	100	50	1600	125	<u>2.8</u>	90
Tuakau Bridge	12	156	75	40	600	115	<u>1.8</u>	80

Lithium (g/m ³)								
Location	Count	Mean	Median	Min	Max	IQR	Skew	5 Yr Median
Taupo Control Gates	12	0.04	0.04	0.04	0.05	0.00	1.34	0.040
Ohaaki Bridge	12	0.08	0.08	0.06	0.11	0.02	0.96	0.083
Ohakuri Tailrace Bridge	12	0.10	0.10	0.07	0.12	0.02	-0.56	0.107
Whakamaru Tailrace	12	0.10	0.11	0.08	0.12	0.02	-0.26	0.110
Waipapa Tailrace	12	0.09	0.09	0.07	0.10	0.02	-0.05	0.095
Narrow s	12	0.08	0.07	0.06	0.10	0.02	0.26	0.086
Horotiu Bridge	12	0.08	0.08	0.06	0.10	0.02	-0.16	0.086
Huntly-Tainui Bridge	12	0.06	0.06	0.03	0.09	0.03	-0.07	0.062
Mercer Bridge	11	0.06	0.05	0.04	0.08	0.03	0.19	0.064
Tuakau Bridge	11	0.06	0.05	0.03	0.08	0.03	0.12	0.064

Nitrate/Nitrite Nitrogen (g/m ³)								
Location	Count	Mean	Median	Min	Max	IQR	Skew	5 Yr Median
Taupo Control Gates	12	0.001	0.001	0.001	0.003	0.001	1.329	0.001
Ohaaki Bridge	12	0.034	0.034	0.022	0.051	0.015	0.336	0.036
Ohakuri Tailrace Bridge	12	0.087	0.090	0.005	0.240	0.113	0.625	0.083
Whakamaru Tailrace	12	0.122	0.103	0.028	0.330	0.127	1.000	0.095
Waipapa Tailrace	12	0.210	0.186	0.077	0.380	0.161	0.510	0.175
Narrow s	12	0.311	0.300	0.103	0.600	0.204	0.553	0.265
Horotiu Bridge	12	0.323	0.300	0.111	0.660	0.207	0.717	0.275
Huntly-Tainui Bridge	12	0.511	0.400	0.179	1.070	0.500	0.648	0.405
Mercer Bridge	12	0.499	0.385	0.156	1.140	0.485	0.712	0.375
Tuakau Bridge	12	0.493	0.370	0.094	1.120	0.495	0.625	0.355

Nitrogen - Ammoniacal (g/m ³)								
Location	Count	Mean	Median	Min	Max	IQR	Skew	5 Yr Median
Taupo Control Gates	12	0.004	0.003	0.003	0.007	0.003	0.76	0.005
Ohaaki Bridge	12	0.008	0.008	0.003	0.018	0.005	1.08	0.005
Ohakuri Tailrace Bridge	12	0.010	0.007	0.003	0.036	0.010	<u>1.92</u>	0.005
Whakamaru Tailrace	12	0.009	0.003	0.003	0.041	0.010	<u>1.97</u>	0.005
Waipapa Tailrace	12	0.014	0.014	0.003	0.030	0.014	0.29	0.015
Narrow s	12	0.015	0.013	0.005	0.028	0.007	0.66	0.015
Horotiu Bridge	12	0.009	0.005	0.005	0.022	0.008	1.10	0.008
Huntly-Tainui Bridge	12	0.016	0.014	0.005	0.041	0.020	0.73	0.011
Mercer Bridge	12	0.014	0.005	0.005	0.061	0.017	<u>1.89</u>	0.005
Tuakau Bridge	12	0.013	0.005	0.005	0.048	0.018	1.47	0.005

Skew = skewness. Underlined values = non-normal distribution. IQR = Inter Quartile Range

Nitrogen - Total Kjeldahl (g/m ³)								
Location	Count	Mean	Median	Min	Max	IQR	Skew	5 Yr Median
Taupo Control Gates	12	0.11	0.08	0.05	0.31	0.05	1.66	0.06
Ohaaki Bridge	12	0.09	0.09	0.07	0.11	0.02	0.00	0.09
Ohakuri Tailrace Bridge	12	0.15	0.14	0.10	0.30	0.07	1.62	0.10
Whakamaru Tailrace	12	0.16	0.16	0.10	0.27	0.04	1.22	0.13
Waipapa Tailrace	12	0.16	0.15	0.12	0.25	0.03	1.66	0.14
Narrow s	12	0.18	0.17	0.11	0.27	0.09	0.50	0.16
Horotiu Bridge	12	0.19	0.16	0.14	0.27	0.11	0.43	0.18
Huntly-Tainui Bridge	12	0.29	0.24	0.18	0.59	0.16	1.31	0.22
Mercer Bridge	12	0.33	0.32	0.15	0.57	0.17	0.27	0.28
Tuakau Bridge	12	0.38	0.38	0.16	0.59	0.30	-0.09	0.29

Nitrogen - Total (g/m ³)								
Location	Count	Mean	Median	Min	Max	IQR	Skew	5 Yr Median
Taupo Control Gates	12	0.11	0.08	0.05	0.31	0.05	1.7	0.06
Ohaaki Bridge	12	0.12	0.12	0.10	0.16	0.03	0.7	0.12
Ohakuri Tailrace Bridge	12	0.24	0.22	0.14	0.39	0.12	0.5	0.20
Whakamaru Tailrace	12	0.28	0.25	0.20	0.50	0.10	1.4	0.25
Waipapa Tailrace	12	0.37	0.35	0.26	0.52	0.16	0.4	0.33
Narrow s	12	0.49	0.52	0.25	0.83	0.22	0.4	0.43
Horotiu Bridge	12	0.51	0.53	0.31	0.91	0.24	0.8	0.46
Huntly-Tainui Bridge	12	0.80	0.68	0.41	1.66	0.47	1.1	0.60
Mercer Bridge	12	0.83	0.68	0.40	1.54	0.70	0.5	0.62
Tuakau Bridge	12	0.87	0.79	0.41	1.71	0.74	0.5	0.62

pH (pH Units)								
Location	Count	Mean	Median	Min	Max	IQR	Skew	5 Yr Median
Taupo Control Gates	12	7.7	7.8	7.5	7.9	0.3	-0.31	7.7
Ohaaki Bridge	12	7.4	7.4	7.0	7.6	0.3	-0.48	7.3
Ohakuri Tailrace Bridge	12	7.5	7.5	7.2	7.6	0.3	-0.47	7.4
Whakamaru Tailrace	12	7.5	7.5	7.1	7.7	0.2	-0.70	7.5
Waipapa Tailrace	12	7.5	7.5	7.3	7.7	0.2	0.13	7.4
Narrow s	12	7.5	7.4	7.2	7.7	0.4	0.17	7.4
Horotiu Bridge	12	7.5	7.5	7.2	7.7	0.3	-0.09	7.5
Huntly-Tainui Bridge	12	7.5	7.5	7.1	7.7	0.3	-0.51	7.4
Mercer Bridge	12	7.5	7.5	7.1	7.8	0.4	-0.22	7.5
Tuakau Bridge	12	7.5	7.6	7.0	8.0	0.5	-0.15	7.5

Phosphorus - Dissolved Reactive (g/m ³)								
Location	Count	Mean	Median	Min	Max	IQR	Skew	5 Yr Median
Taupo Control Gates	12	0.002	0.002	0.001	0.003	0.001	-0.34	0.002
Ohaaki Bridge	12	0.007	0.007	0.003	0.010	0.002	-0.23	0.006
Ohakuri Tailrace Bridge	12	0.010	0.010	0.004	0.020	0.006	0.51	0.010
Whakamaru Tailrace	12	0.011	0.010	0.004	0.021	0.006	0.69	0.009
Waipapa Tailrace	12	0.017	0.017	0.006	0.025	0.007	-0.42	0.017
Narrow s	12	0.016	0.016	0.005	0.029	0.009	0.11	0.016
Horotiu Bridge	12	0.020	0.019	0.012	0.038	0.009	1.16	0.020
Huntly-Tainui Bridge	12	0.022	0.022	0.012	0.033	0.007	0.05	0.021
Mercer Bridge	12	0.018	0.018	0.007	0.033	0.012	0.22	0.016
Tuakau Bridge	12	0.016	0.016	0.005	0.029	0.009	0.13	0.014

Skew = skewness. Underlined values = non-normal distribution. IQR = Inter Quartile Range

Phosphorus - Total (g/m ³)								
Location	Count	Mean	Median	Min	Max	IQR	Skew	5 Yr Median
Taupo Control Gates	12	0.006	0.004	0.002	0.026	0.004	<u>2.5</u>	0.004
Ohaaki Bridge	12	0.011	0.010	0.007	0.016	0.006	0.4	0.010
Ohakuri Tailrace Bridge	12	0.022	0.022	0.014	0.031	0.008	0.2	0.019
Whakamaru Tailrace	12	0.029	0.025	0.011	0.060	0.015	0.9	0.021
Waipapa Tailrace	12	0.027	0.028	0.014	0.037	0.007	-0.3	0.026
Narrow s	12	0.029	0.029	0.022	0.038	0.006	0.2	0.029
Horotiu Bridge	12	0.034	0.033	0.025	0.054	0.006	1.5	0.034
Huntly-Tainui Bridge	12	0.052	0.043	0.033	0.130	0.011	<u>2.1</u>	0.042
Mercer Bridge	12	0.053	0.049	0.035	0.096	0.019	1.3	0.046
Tuakau Bridge	12	0.056	0.052	0.034	0.100	0.029	0.8	0.050

Temperature (°C)								
Location	Count	Mean	Median	Min	Max	IQR	Skew	5 Yr Median
Taupo Control Gates	12	15.0	14.5	10.3	21.3	6.0	0.33	14.6
Ohaaki Bridge	12	16.4	15.8	11.0	23.2	6.4	0.28	16.2
Ohakuri Tailrace Bridge	12	16.6	16.5	11.3	23.3	7.6	0.17	16.5
Whakamaru Tailrace	12	16.9	16.7	11.5	23.3	7.0	0.21	16.6
Waipapa Tailrace	12	16.6	16.6	11.4	23.0	7.1	0.18	16.3
Narrow s	12	16.3	16.4	11.2	22.9	6.6	0.26	16.0
Horotiu Bridge	12	16.6	16.4	11.3	23.1	7.3	0.14	16.2
Huntly-Tainui Bridge	12	16.8	16.6	10.8	24.4	8.0	0.16	16.3
Mercer Bridge	12	17.2	17.0	11.1	25.6	7.7	0.27	16.6
Tuakau Bridge	12	17.6	17.4	11.1	25.7	8.2	0.15	17.2

Dissolved Solids - Total (g/m ³)								
Location	Count	Mean	Median	Min	Max	IQR	Skew	5 Yr Median
Taupo Control Gates	12	88	87	75	100	8	-0.07	88
Ohaaki Bridge	12	108	111	87	125	14	-0.41	110
Ohakuri Tailrace Bridge	12	121	121	99	140	15	0.02	122
Whakamaru Tailrace	12	123	122	104	137	11	-0.30	126
Waipapa Tailrace	12	119	119	107	134	11	0.24	123
Narrow s	12	119	121	93	131	14	-1.06	124
Horotiu Bridge	12	119	118	106	132	15	-0.04	122
Huntly-Tainui Bridge	12	115	116	102	129	13	-0.05	116
Mercer Bridge	12	120	121	105	136	14	-0.06	122
Tuakau Bridge	12	120	120	108	130	17	-0.01	121

Turbidity (NTU)								
Location	Count	Mean	Median	Min	Max	IQR	Skew	5 Yr Median
Taupo Control Gates	12	0.5	0.5	0.2	1.2	0.2	<u>1.8</u>	0.5
Ohaaki Bridge	12	0.8	0.7	0.4	1.3	0.4	0.4	0.7
Ohakuri Tailrace Bridge	12	1.3	1.3	0.7	2.6	0.4	1.3	1.0
Whakamaru Tailrace	12	1.5	1.4	0.7	3.3	0.9	1.2	1.2
Waipapa Tailrace	12	1.2	1.2	0.9	1.6	0.4	0.3	1.3
Narrow s	12	2.2	1.6	1.2	4.2	1.6	1.0	1.8
Horotiu Bridge	12	2.5	2.2	1.4	5.3	1.3	1.2	2.4
Huntly-Tainui Bridge	12	7.0	5.0	2.5	19.5	4.9	1.4	5.3
Mercer Bridge	12	9.5	8.5	2.4	20.0	8.4	0.6	8.2
Tuakau Bridge	12	10.4	9.1	2.2	22.0	9.7	0.5	8.8

Skew = skewness. Underlined values = non-normal distribution. IQR = Inter Quartile Range

5-Yearly major ion summary statistics

Calcium - dissolved (g/m ³)							
Location	Count	Mean	Median	Min	Max	IQR	Skew
Taupo Control Gates	12	6.76	6.80	6.40	7.00	0.10	-0.93
Ohaaki Bridge	12	6.95	6.95	6.60	7.20	0.25	-0.34
Ohakuri Tailrace Bridge	12	6.91	6.90	6.70	7.30	0.20	0.83
Whakamaru Tailrace	12	6.68	6.65	6.30	7.10	0.20	0.44
Waipapa Tailrace	12	6.50	6.50	6.10	6.90	0.45	0.10
Narrow s	12	6.56	6.50	6.20	7.00	0.25	0.46
Horotiu Bridge	12	6.51	6.50	6.10	6.90	0.25	-0.06
Huntly-Tainui Bridge	12	7.54	7.60	6.50	8.40	0.75	-0.39
Mercer Bridge	12	8.12	8.35	6.90	9.10	1.35	-0.14
Tuakau Bridge	12	8.26	8.25	7.00	9.90	1.70	0.24

Magnesium - dissolved (g/m ³)							
Location	Count	Mean	Median	Min	Max	IQR	Skew
Taupo Control Gates	12	2.89	2.85	2.80	3.10	0.15	0.89
Ohaaki Bridge	12	2.99	3.00	2.80	3.10	0.20	-0.41
Ohakuri Tailrace Bridge	12	2.93	2.90	2.80	3.20	0.20	0.64
Whakamaru Tailrace	12	2.83	2.85	2.70	3.10	0.20	0.55
Waipapa Tailrace	12	2.66	2.65	2.40	2.90	0.10	-0.05
Narrow s	12	2.79	2.80	2.50	3.30	0.30	0.61
Horotiu Bridge	12	2.76	2.80	2.40	3.10	0.25	-0.25
Huntly-Tainui Bridge	12	2.63	2.60	2.30	3.10	0.30	0.37
Mercer Bridge	12	2.78	2.80	2.40	3.20	0.20	-0.02
Tuakau Bridge	12	2.83	2.80	2.40	3.20	0.15	-0.16

Potassium - dissolved (g/m ³)							
Location	Count	Mean	Median	Min	Max	IQR	Skew
Taupo Control Gates	12	2.01	2.00	1.80	2.20	0.17	-0.08
Ohaaki Bridge	12	2.63	2.60	2.40	3.00	0.25	0.57
Ohakuri Tailrace Bridge	12	3.10	3.10	2.70	3.40	0.40	-0.09
Whakamaru Tailrace	12	3.15	3.20	2.70	3.80	0.40	0.40
Waipapa Tailrace	12	3.09	3.10	2.70	3.40	0.30	-0.21
Narrow s	12	3.28	3.30	3.00	3.70	0.35	0.22
Horotiu Bridge	12	3.27	3.30	2.90	3.60	0.35	-0.32
Huntly-Tainui Bridge	12	3.16	3.20	2.70	3.50	0.35	-0.52
Mercer Bridge	12	3.25	3.35	2.80	3.50	0.35	-0.76
Tuakau Bridge	12	3.28	3.30	2.80	3.60	0.30	-0.70

Sodium - dissolved (g/m ³)							
Location	Count	Mean	Median	Min	Max	IQR	Skew
Taupo Control Gates	12	12.9	12.8	12.4	13.8	0.6	0.80
Ohaaki Bridge	12	17.8	17.3	15.9	21.0	2.2	0.74
Ohakuri Tailrace Bridge	12	21.2	21.5	17.4	24.0	2.6	-0.47
Whakamaru Tailrace	12	20.6	20.5	18.7	23.0	2.8	0.04
Waipapa Tailrace	12	19.8	19.7	17.3	22.0	2.3	0.03
Narrow s	12	19.2	19.2	14.8	23.0	3.1	-0.24
Horotiu Bridge	12	19.5	19.7	15.0	25.0	3.4	0.29
Huntly-Tainui Bridge	12	17.1	16.4	11.9	22.0	4.7	-0.07
Mercer Bridge	12	16.9	16.6	11.5	21.0	3.8	-0.17
Tuakau Bridge	12	17.1	16.7	11.4	22.0	3.4	-0.08

Skew = skewness. Underlined values = non-normal distribution. IQR = Inter Quartile Range

Alkalinity (units: (g/m ³) CaCO ₃)							
Location	Count	Mean	Median	Min	Max	IQR	Skew
Taupo Control Gates	12	39	39	38	40	1	0.08
Ohaaki Bridge	12	41	40	39	44	2	1.00
Ohakuri Tailrace Bridge	12	42	43	40	44	2	-0.32
Whakamaru Tailrace	12	42	42	39	44	3	-0.34
Waipapa Tailrace	12	40	40	37	42	3	-0.43
Narrow s	12	39	39	34	42	5	-0.40
Horotiu Bridge	12	39	39	34	43	5	-0.27
Huntly-Tainui Bridge	12	37	37	28	43	8	-0.47
Mercer Bridge	12	37	38	28	44	8	-0.32
Tuakau Bridge	12	37	38	27	43	9	-0.40

Bicarbonate (units: (g/m ³) HCO ₃)							
Location	Count	Mean	Median	Min	Max	IQR	Skew
Taupo Control Gates	12	47	47	46	48	1	0.05
Ohaaki Bridge	12	50	49	48	53	2	0.92
Ohakuri Tailrace Bridge	12	51	52	48	53	3	-0.73
Whakamaru Tailrace	12	51	51	48	53	3	-0.24
Waipapa Tailrace	12	48	49	45	51	3	-0.35
Narrow s	12	48	48	42	52	5	-0.20
Horotiu Bridge	12	48	47	41	52	6	-0.35
Huntly-Tainui Bridge	12	45	45	35	52	9	-0.43
Mercer Bridge	12	45	46	34	53	10	-0.35
Tuakau Bridge	12	45	46	33	52	11	-0.48

Sulphate (g/m ³)							
Location	Count	Mean	Median	Min	Max	IQR	Skew
Taupo Control Gates	12	7.2	7.2	7.0	7.5	0.4	0.52
Ohaaki Bridge	12	8.2	8.2	7.6	9.1	0.4	0.90
Ohakuri Tailrace Bridge	12	9.6	9.3	8.9	11.0	1.2	0.74
Whakamaru Tailrace	12	8.9	8.7	8.0	11.2	0.7	1.92
Waipapa Tailrace	12	8.6	8.7	7.5	9.2	0.9	-0.54
Narrow s	12	9.1	8.6	7.5	13.0	1.1	1.78
Horotiu Bridge	12	8.9	8.9	7.7	9.9	0.7	-0.03
Huntly-Tainui Bridge	12	8.6	8.4	7.0	11.1	1.2	0.86
Mercer Bridge	12	9.8	9.3	7.7	12.6	2.2	0.54
Tuakau Bridge	12	10.2	9.5	7.7	14.4	2.4	0.78

Silica - dissolved reactive (units: (g/m ³) SiO ₂)							
Location	Count	Mean	Median	Min	Max	IQR	Skew
Taupo Control Gates	12	24.4	25.0	23.0	25.0	1.0	-0.86
Ohaaki Bridge	12	28.6	28.5	26.0	33.0	1.5	1.07
Ohakuri Tailrace Bridge	12	33.6	34.0	30.0	36.0	2.0	-0.75
Whakamaru Tailrace	12	35.8	36.5	32.0	38.0	3.5	-0.59
Waipapa Tailrace	12	36.3	36.5	33.0	39.0	2.5	-0.29
Narrow s	12	37.6	37.0	32.0	45.0	4.5	0.40
Horotiu Bridge	12	36.5	37.0	31.0	39.0	4.0	-0.85
Huntly-Tainui Bridge	12	33.3	33.5	27.0	37.0	5.0	-0.49
Mercer Bridge	12	32.2	31.5	27.0	38.0	4.0	0.37
Tuakau Bridge	12	31.5	31.5	25.0	38.0	5.5	0.20

Skew = skewness. Underlined values = non-normal distribution. IQR = Inter Quartile Range

Boxplots are used to present data

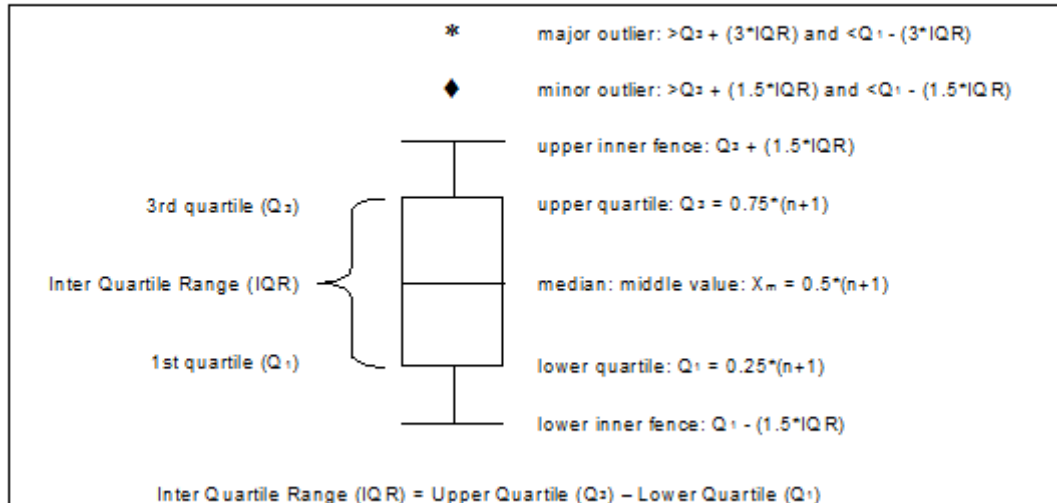

Black Disk, 2012-2016 Data

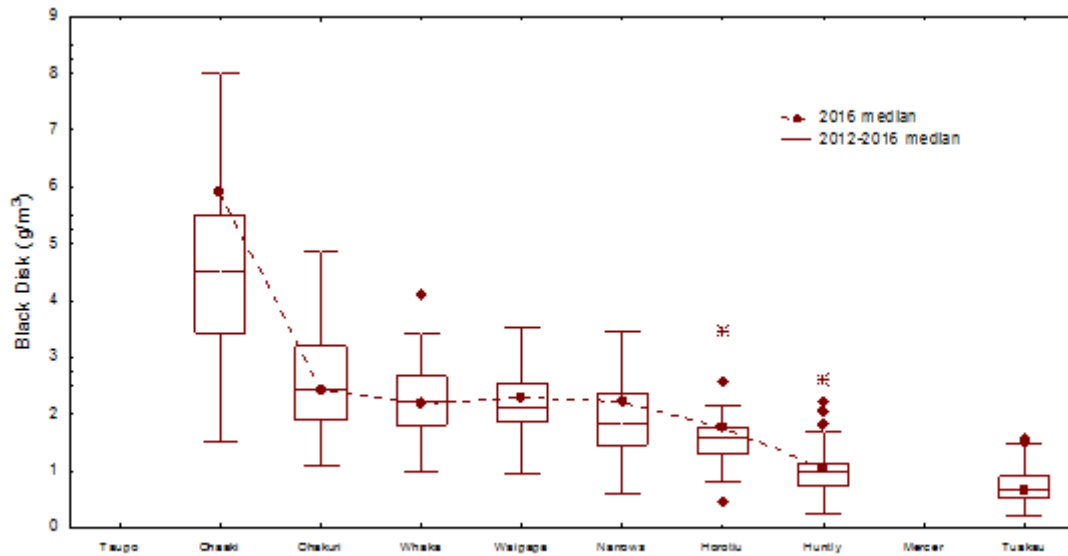

Colour, 2012-2016 Data

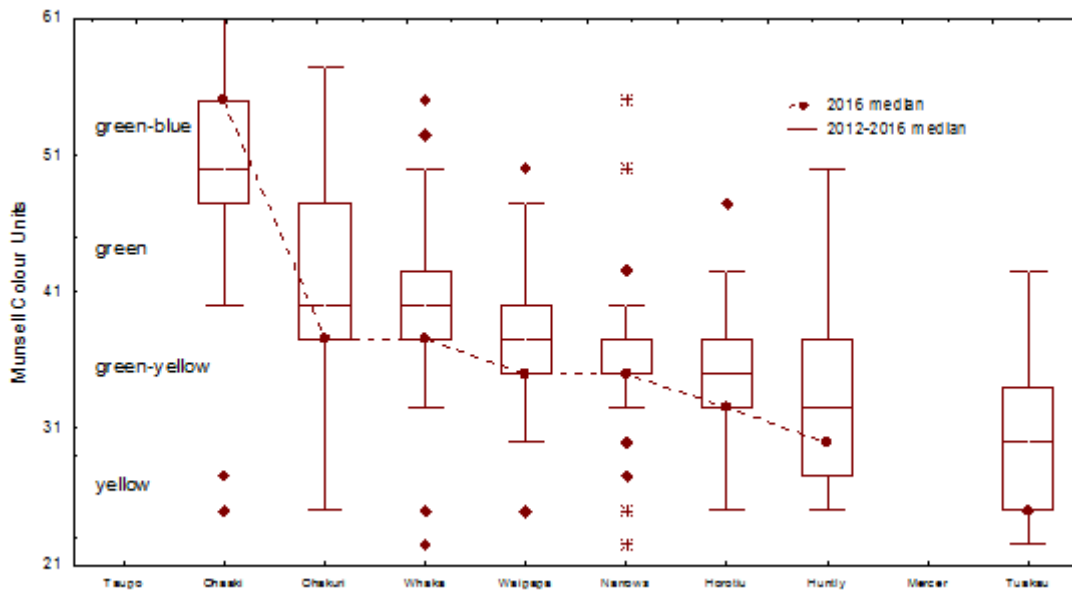

Total Nitrogen, 2012-2016 Data

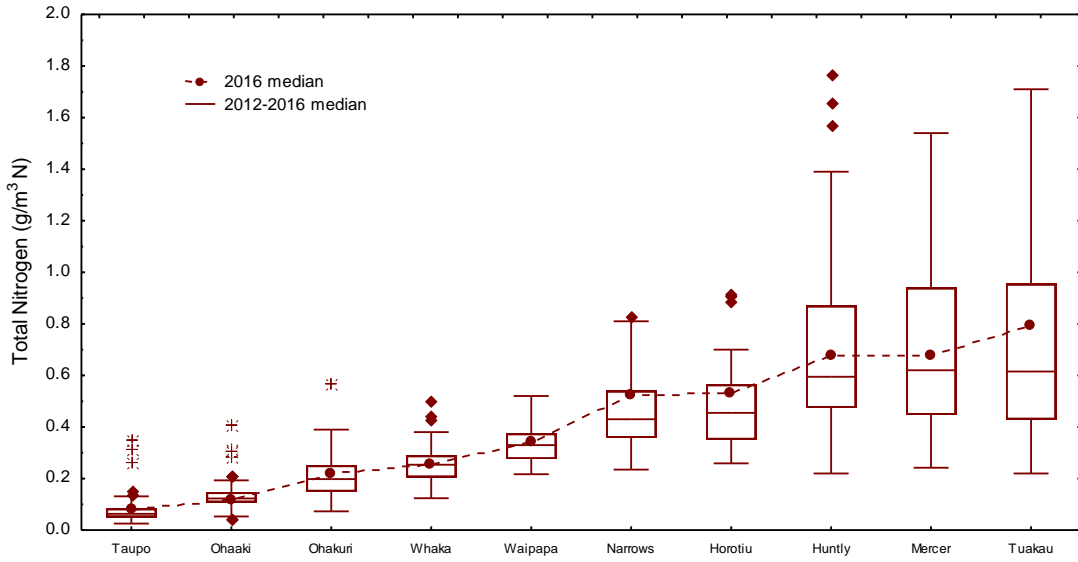

Total Phosphorus, 2012-2016 Data

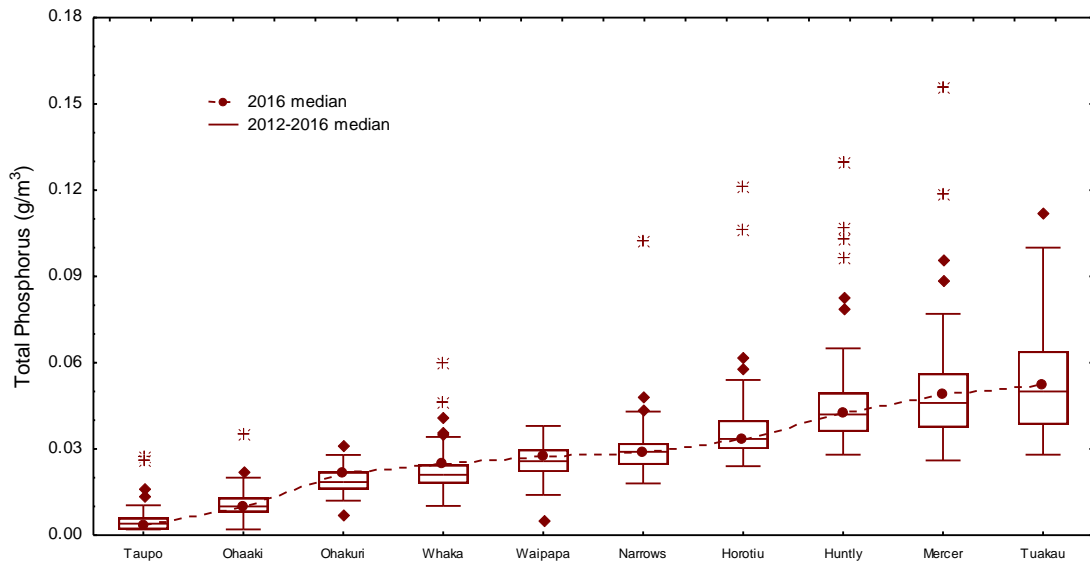

E.coli, 2012-2016 Data

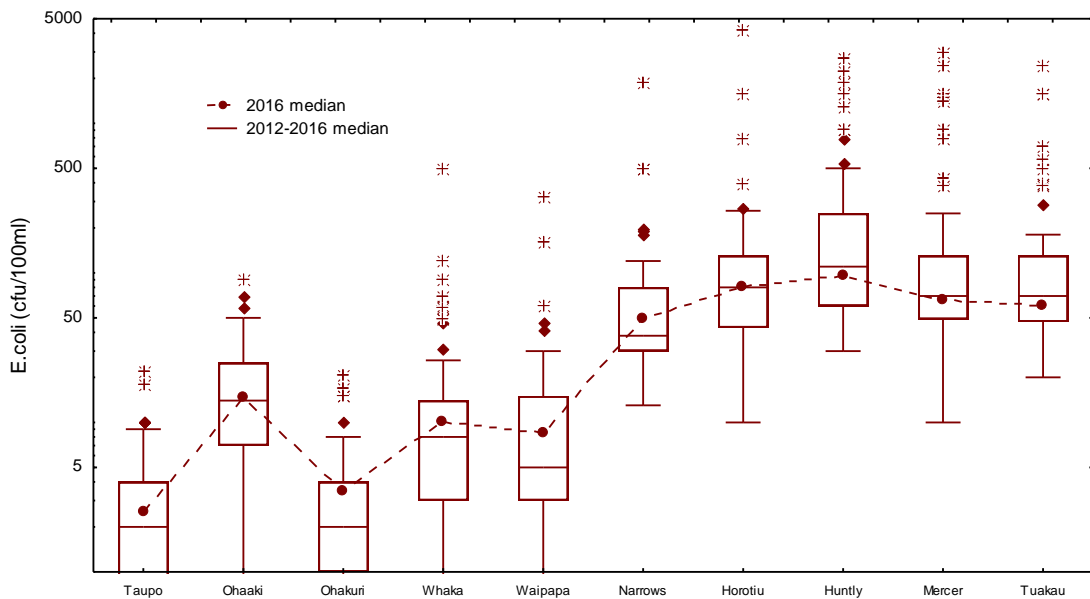

Ammoniacal Nitrogen, 2012-2016 Data

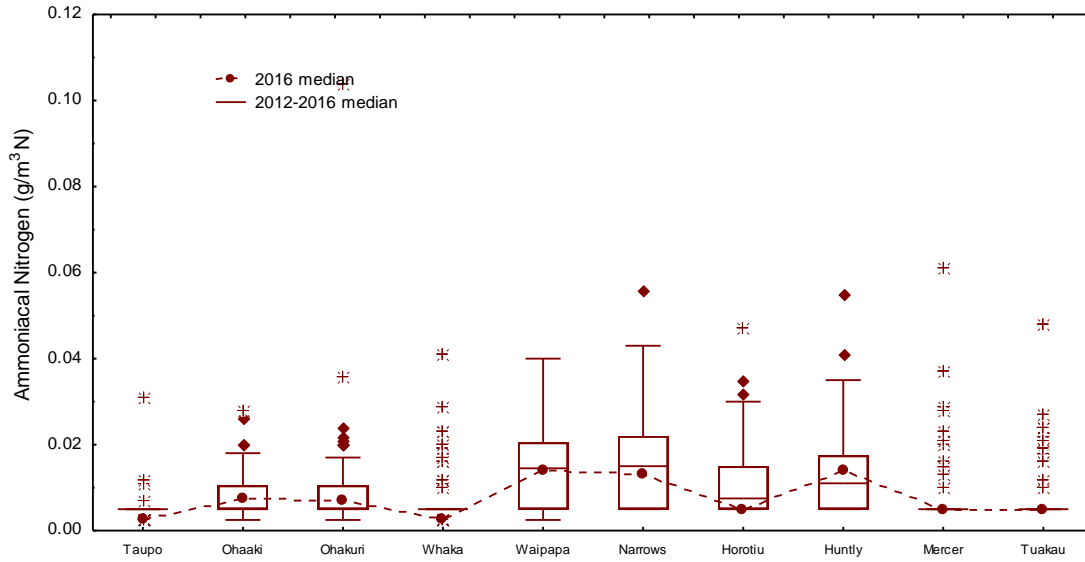

pH, 2012-2016 Data

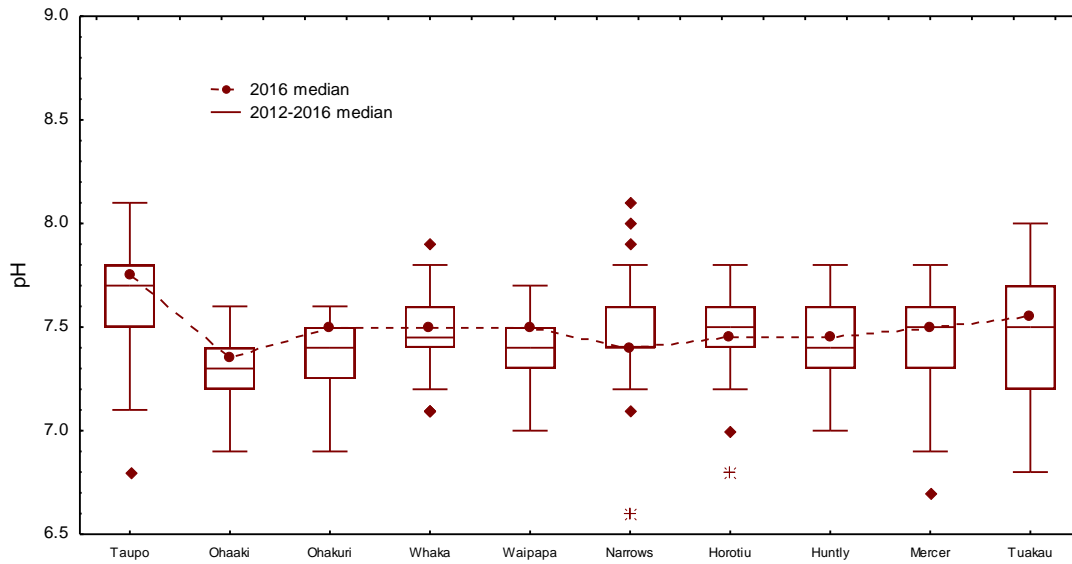

Temperature, 2012-2016 Data

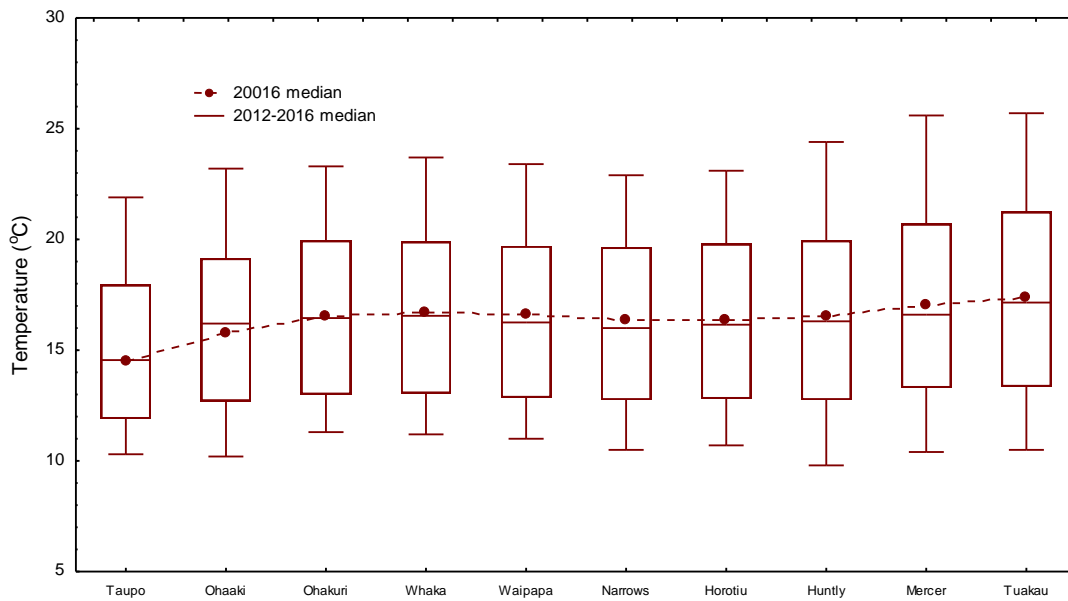

Total Arsenic, 2012-2016 Data

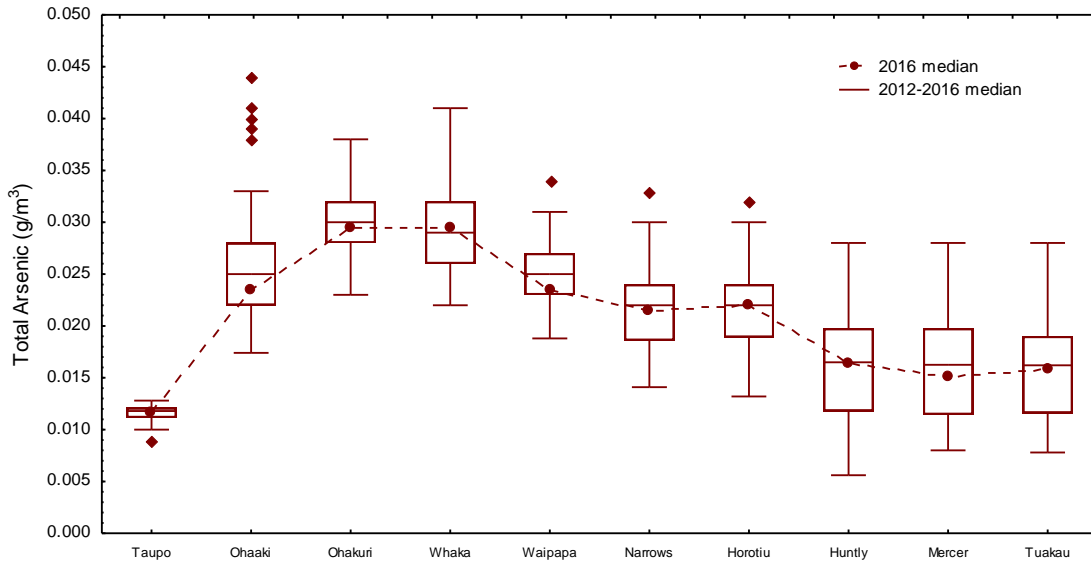

Boron, 2012-2016 Data

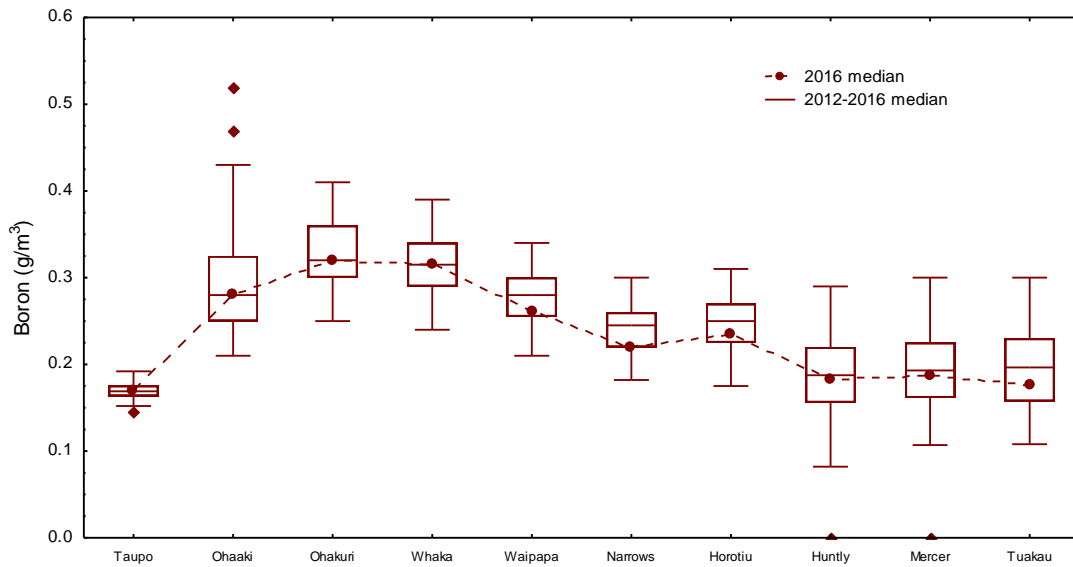

Dissolved Oxygen, 2012-2016 Data

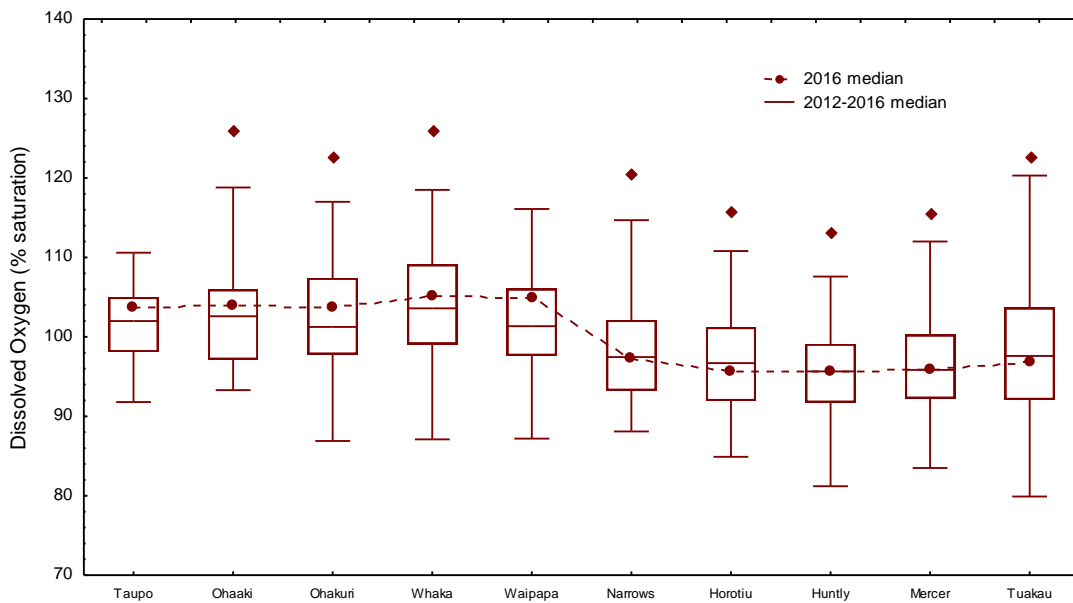

Comparison with water quality standards

Table 3: Number of samples (year 2016) complying with the 'satisfactory' water quality guidelines and standards. n = 12 (except * where n = 11 & ^ where n=10).

Location	ECOLOGICAL HEALTH							HUMAN USES					
								Recreation			water supply	drinking water	
	DO	pH	Turb	NH ₄ N	Temp	TP	TN	Bk ¹ Disk	E coli	Median E coli	CHL _a	As	B
Taupo Gates	12	12	12	12	8	12	12	-	12	Y	12	0	12
Ohaaki Bridge	12	12	12	12	6	12	12	10/11*	12	Y	12	0	12
Ohakuri Tailrace Br	12	12	12	12	5	12	12	8/10*	12	Y	11	0	12
Whakamaru Tailrace	12	12	12	12	5	10	11	8/9*	12	Y	10	0	12
Waipapa Tailrace	12	12	12	12	5	12	10	9/9^	12	Y	12	0	12
Hamilton – Narrows	12	12	12	12	6	12	5	8/10*	12	Y	11	0	12
Horotiu Bridge	12	12	11	12	6	10	5	7/11*	12	Y	12	0	12
Huntly – Tainui Br	12	12	6	12	6	3	3	1/9*	11	Y	12	2	12
Mercer Bridge	12	12	2	12	5	3	4	-	11	Y	9	2	12
Tuakau Bridge	11	12	3	12	5	4	4	0/10*	12	Y	8	3	12

¹samples complying with the baseflow water clarity guideline from the number of samples measured when flow was **below the upper decile of all flows**

Table 4: Number of samples (year 2016) complying with the 'excellent' water quality guidelines and standards. n = 12 (except * where n = 11 & ^ where n=10).

Location	ECOLOGICAL HEALTH							HUMAN USES					
								Recreation			water supply	Drinking water	
	DO	pH	Turb	NH ₄ N	Temp	TP	TN	Bk ¹ Disk	E coli	Median E coli	CHL _a	As	B
Taupo Gates	12	12	12	12	2	11	7	-	12	Y	12	n/a	n/a
Ohaaki Bridge	12	12	12	12	2	4	0	9/11*	11	Y	12	n/a	n/a
Ohakuri Tailrace Br	12	12	11	12	2	0	0	0/10*	12	Y	5	n/a	n/a
Whakamaru Tailrace	11	12	10	12	2	0	0	0/9*	10	Y	3	n/a	n/a
Waipapa Tailrace	11	12	12	12	1	0	0	0/9^	12	Y	7	n/a	n/a
Hamilton – Narrows	12	12	8	12	2	0	0	0/10*	7	N	4	n/a	n/a
Horotiu Bridge	12	12	4	12	1	0	0	0/11*	3	N	4	n/a	n/a
Huntly – Tainui Br	12	12	0	12	1	0	0	0/9*	4	N	3	n/a	n/a
Mercer Bridge	9	12	0	12	1	0	0	-	3	N	2	n/a	n/a
Tuakau Bridge	8	12	0	12	1	0	0	0/10*	2	N	2	n/a	n/a

¹samples complying with the baseflow water clarity guideline from the number of samples measured when flow was **below the upper decile of all flows**

DATE	TIME*	FLOW	BDISK	COLOR	COND	PH	TEMP	DO	PCDO	BOD5	TURB	TDS	NNN	NO3-N	NH4-N
dd/mm/yy	hh:mm	m ³ /s	m	units	mS/m	units	°C	g/m ³	%Sat	g/m ³	NTU	g/m ³	g/m ³	g/m ³	g/m ³

Satisfactory Water Quality Guideline/Standard >1.6 - - 6.5-9 <12 (May-Sep) >80 - <5 - - - <0.88
<20 (Oct-Apr)

1131-91 UD = 621 m³/s (Flows from Mercer Bridge Recorder)

Waikato River at Mercer Br

06/01/16	9:43 a.m.	230	-	-	15.2	7.8	<u>21.1</u>	8.5	96.2	1.2	<u>5.9</u>	107	0.220	0.220	< 0.01
03/02/16	10:25 a.m.	213	-	-	16.9	7.8	<u>25.6</u>	8.8	107.7	1.9	<u>5.2</u>	129	0.156	0.154	< 0.01
03/03/16	9:45 a.m.	253	-	-	16.5	7.6	<u>21.6</u>	8.9	98.9	1.9	<u>7.7</u>	126	0.198	0.195	< 0.01
06/04/16	10:45 a.m.	271	-	-	16.0	7.7	<u>19.1</u>	9.2	98.3	1.0	4.0	126	0.250	0.240	< 0.01
04/05/16	10:45 a.m.	269	-	-	16.7	7.6	<u>17.2</u>	9.3	95.7	1.8	2.4	125	0.330	0.330	< 0.01
08/06/16	10:35 a.m.	309	-	-	16.0	7.3	<u>12.8</u>	9.6	89.6	1.5	<u>9.2</u>	115	0.610	0.610	0.06
07/07/16	10:42 a.m.	545	-	-	15.6	7.3	11.1	9.8	88.0	0.9	<u>9.4</u>	115	0.930	0.930	0.02
03/08/16	11:07 a.m.	781	-	-	14.8	7.1	11.8	9.7	89.9	0.8	<u>15.9</u>	136	1.140	1.140	0.03
07/09/16	11:00 a.m.	410	-	-	14.9	7.4	<u>13.2</u>	10.0	94.6	1.3	<u>14.3</u>	116	0.640	0.640	< 0.01
05/10/16	9:30 a.m.	709	-	-	14.0	7.1	15.2	9.1	90.9	1.4	<u>20.0</u>	112	0.800	0.790	0.02
02/11/16	10:02 a.m.	344	-	-	14.4	7.5	16.8	9.5	98.1	0.8	<u>13.5</u>	105	0.440	0.440	< 0.01
07/12/16	10:12 a.m.	297	-	-	14.9	7.5	<u>20.3</u>	10.2	112.0	2.1	<u>7.0</u>	129	0.270	0.260	< 0.01

1131-133 UD = 621 m³/s (Flows from Mercer Bridge Recorder)

Waikato River at Tuakau Br

06/01/16	10:08 a.m.	231	<u>1.0</u>	25.0	15.3	7.8	<u>21.6</u>	8.9	101.4	1.4	4.9	111	0.250	0.240	< 0.01
03/02/16	10:56 a.m.	211	<u>0.7</u>	30.0	16.9	8.0	<u>25.7</u>	9.7	119.0	2.0	<u>6.2</u>	130	0.094	0.092	< 0.01
03/03/16	10:20 a.m.	253	<u>0.9</u>	30.0	16.4	7.6	<u>22.6</u>	8.8	100.2	1.3	<u>5.5</u>	130	0.199	0.197	< 0.01
06/04/16	11:10 a.m.	279	<u>1.4</u>	32.5	16.1	7.9	19.9	9.0	97.9	1.2	2.5	130	0.250	0.250	< 0.01
04/05/16	11:05 a.m.	267	<u>1.6</u>	30.0	16.8	7.7	<u>17.8</u>	9.4	97.1	0.9	2.2	127	0.330	0.330	< 0.01
08/06/16	11:00 a.m.	309	<u>0.7</u>	34.0	16.3	7.3	<u>12.9</u>	9.6	89.1	1.0	<u>9.4</u>	116	0.690	0.690	0.03
07/07/16	11:15 a.m.	543	<u>0.7</u>	25.0	16.2	7.2	11.1	8.9	<u>79.9</u>	1.4	<u>13.0</u>	125	0.970	0.960	0.05
03/08/16	11:32 a.m.	782	-	-	15.0	7.0	11.8	9.0	83.6	0.8	<u>14.1</u>	124	1.120	1.110	0.02
07/09/16	11:25 a.m.	410	<u>0.2</u>	25.0	15.2	7.3	<u>13.6</u>	9.7	92.4	1.5	<u>22.0</u>	110	0.610	0.610	< 0.01
05/10/16	10:48 a.m.	707	<u>(0.4)</u>	25.0	14.1	7.0	15.7	8.6	87.4	1.5	<u>21.0</u>	114	0.770	0.760	0.02
02/11/16	10:38 a.m.	345	<u>0.3</u>	25.0	14.4	7.5	16.9	9.4	96.7	1.6	<u>15.6</u>	108	0.410	0.400	< 0.01
07/12/16	11:32 a.m.	297	<u>0.5</u>	25.0	14.9	7.7	<u>21.2</u>	11.0	122.6	2.1	<u>8.7</u>	112	0.220	0.220	< 0.01

Note: < = less than the value stated

UD = upper decile flow (long-term record 1997-2016 inclusive)

*New Zealand Standard Time

Underlined values don't comply with the "satisfactory" water quality Guidelines and Standards - Table 1

() black disk measurements taken in flows above upper decile values – don't assess for compliance

TKN g/m ³	TN g/m ³	DRP g/m ³	TP g/m ³	CL g/m ³	AS g/m ³	B g/m ³	LI g/m ³	A340F /cm	A440F /cm	ENT cfu/100mL	FC	Ecoli	CHLA g/m ³	DOC g/m ³	TOC g/m ³
-	<0.5	-	<0.04	-	<0.01	<0.3	-	-	-	<77	-	<550	<0.02		

0.18	0.40	0.016	0.040	16.3	<u>0.015</u>	0.19	0.064	0.021	0.004	7	80	70	0.019	1.7	2.2
0.28	0.44	0.008	0.035	17.9	<u>0.020</u>	0.24	0.079	0.014	< 0.002	40	60	60	<u>0.024</u>	2.2	2.1
0.41	<u>0.61</u>	0.018	<u>0.044</u>	16.9	<u>0.019</u>	0.20	0.066	0.021	0.004	60	100	80	0.014	2.2	2.7
0.19	0.44	0.022	<u>0.046</u>	16.5	<u>0.020</u>	0.22	0.072	0.014	0.003	33	120	110	0.005	1.3	1.6
0.15	0.48	0.026	0.037	17.3	<u>0.021</u>	0.24	0.082	0.014	0.003	52	120	50	0.005	1.7	1.8
0.48	<u>1.09</u>	0.007	<u>0.052</u>	17.4	<u>0.014</u>	0.18	0.054	0.034	0.006	33	50	50	0.009	3.9	4.4
0.30	<u>1.23</u>	0.021	0.039	16.2	<u>0.011</u>	0.17	0.052	0.035	0.006	22	60	60	0.004	3.8	4.0
0.40	<u>1.54</u>	0.033	<u>0.077</u>	15.5	0.009	0.12	0.038	0.047	0.008	47	250	250	< 0.003	4.3	4.8
0.37	<u>1.01</u>	0.018	<u>0.060</u>	15.3	<u>0.011</u>	0.15	0.042	0.032	0.006	12	380	380	0.012	2.7	3.7
0.57	<u>1.37</u>	0.022	<u>0.096</u>	13.8	0.009	0.13	0.037	0.068	0.012	<u>120</u>	1600	<u>1400</u>	0.018	5.3	6.3
0.31	<u>0.75</u>	0.012	<u>0.057</u>	13.3	<u>0.015</u>	0.15	0.044	0.025	0.005	8	58	58	<u>0.021</u>	2.1	2.9
0.33	<u>0.60</u>	0.007	<u>0.052</u>	15.1	<u>0.016</u>	0.19	0.054	0.021	0.004	9	100	50	<u>0.037</u>	2.0	2.9
0.23	0.48	0.018	0.040	16.8	<u>0.016</u>	0.19	0.062	0.021	0.004	8	40	34	0.017	1.6	2.6
0.34	0.43	0.006	0.034	18.0	<u>0.019</u>	0.24	0.078	0.005	< 0.002	40	60	60	<u>0.029</u>	2.4	2.1
0.21	0.41	0.018	0.038	17.2	<u>0.018</u>	0.20	0.068	0.022	0.004	39	80	60	0.013	2.3	2.4
0.16	0.41	0.022	0.039	16.7	<u>0.020</u>	0.23	0.075	0.013	0.002	41	60	60	0.006	1.4	2.0
0.19	<u>0.52</u>	0.022	0.034	17.0	<u>0.021</u>	0.25	0.082	0.013	0.003	<u>160</u>	180	150	< 0.003	1.8	1.7
0.34	<u>1.03</u>	0.012	<u>0.052</u>	17.1	<u>0.013</u>	0.17	0.049	0.028	0.005	46	57	53	0.007	3.1	3.7
0.49	<u>1.46</u>	0.013	<u>0.064</u>	17.0	0.010	0.15	0.045	0.060	0.012	22	60	60	0.007	5.0	5.9
0.59	<u>1.71</u>	0.029	<u>0.070</u>	16.0	0.008	0.11	0.036	0.055	0.010	44	170	130	0.004	4.9	5.4
0.47	<u>1.08</u>	0.013	<u>0.081</u>	15.7	<u>0.012</u>	0.14	0.042	0.036	0.007	7	380	380	0.018	3.1	3.9
0.54	<u>1.31</u>	0.020	<u>0.100</u>	13.9	0.008	0.11	0.031	0.077	0.014	<u>110</u>	600	500	<u>0.021</u>	5.9	7.0
0.54	<u>0.95</u>	0.012	<u>0.064</u>	13.5	<u>0.016</u>	0.14	0.045	0.031	0.006	20	70	70	<u>0.026</u>	2.5	3.5
0.41	<u>0.63</u>	0.005	<u>0.052</u>	15.3	<u>0.016</u>	0.18	0.054	0.024	0.005	16	110	60	<u>0.045</u>	1.8	3.4

Note: < = less than the value stated

UD = upper decile flow (long-term record 1996-2015 inclusive)

*New Zealand Standard Time

Underlined values don't comply with the "satisfactory" water quality Guidelines and Standards - Table 1

3.2 Waikato River monitoring programme

Bathing season microbiological survey

Summary statistics

Comparison with water quality standards

Parameter graph

Raw data

Table 5: Bathing season median E. coli bacteria.

Location Name	BATHING SEASON MEDIAN					5 Season
	06/07	08/09	10/11	12/13	16/17	Median
Taupo Gates	2	3	8	6	6	6
Huka Falls	8	13	15	9	16	13
Ohaaki Bridge	16	41	19	18	32	19
Ohakuri Tailrace Br	2	3	3	3	3	3
Whakamaru Tailrace	6	10	18	8	8	8
Waipapa Tailrace	6	6	7	6	7	6
Lake Karapiro Boatramp	8	25	45	30	125	30
Narrows Br	55	83	60	34	60	60
Wellington Street Beach	84	80	80	43	70	80
Sewer Br Alandale	100	120	130	70	130	120
Horotiu Br	150	120	110	64	90	110
Ngaruawahia Br	140	120	240	65	110	120
Huntly-Tainui Br	150	160	160	75	140	150
Mercer Br	85	115	160	48	80	85
Tuakau Br	50	105	80	41	60	60
Maraetai Bay	-	-	20	22	27	22
Waipa River (Ngaruawahia Br)	90	130	100	52	105	100

Table 6: Year 2016/17 bathing season E. coli survey results complying with the “Satisfactory” and “Excellent” water quality guidelines. n = 12 (except * where n = 13).

Location Name	HUMAN USES - RECREATION			
	SATISFACTORY		EXCELLENT	
	<i>E. coli</i> Samples < 550	<i>E. coli</i> Median <126	<i>E. coli</i> Samples < 55	<i>E. coli</i> Median <23
Taupo Gates	13*	Y*	13*	Y*
Huka Falls	12	Y	12	Y
Ohaaki Bridge	13*	Y*	9*	N*
Ohakuri Tailrace Br	13*	Y*	13*	Y*
Whakamaru Tailrace	13*	Y*	13*	Y*
Waipapa Tailrace	13*	Y*	13*	Y*
Lake Karapiro Boatramp	12	Y	4	N
Narrows Br	13*	Y*	6*	N*
Wellington Street Beach	12	Y	3	N
Sewer Br Alandale	12	N	2	N
Horotiu Br	12	Y	1	N
Ngaruawahia Br	12	Y	1	N
Huntly-Tainui Br	12	N	2	N
Mercer Br	12	Y	3	N
Tuakau Br	12	Y	4	N
Maraetai Bay	12	Y	11	N
Waipa River (Ngaruawahia Br)	12	Y	3	N

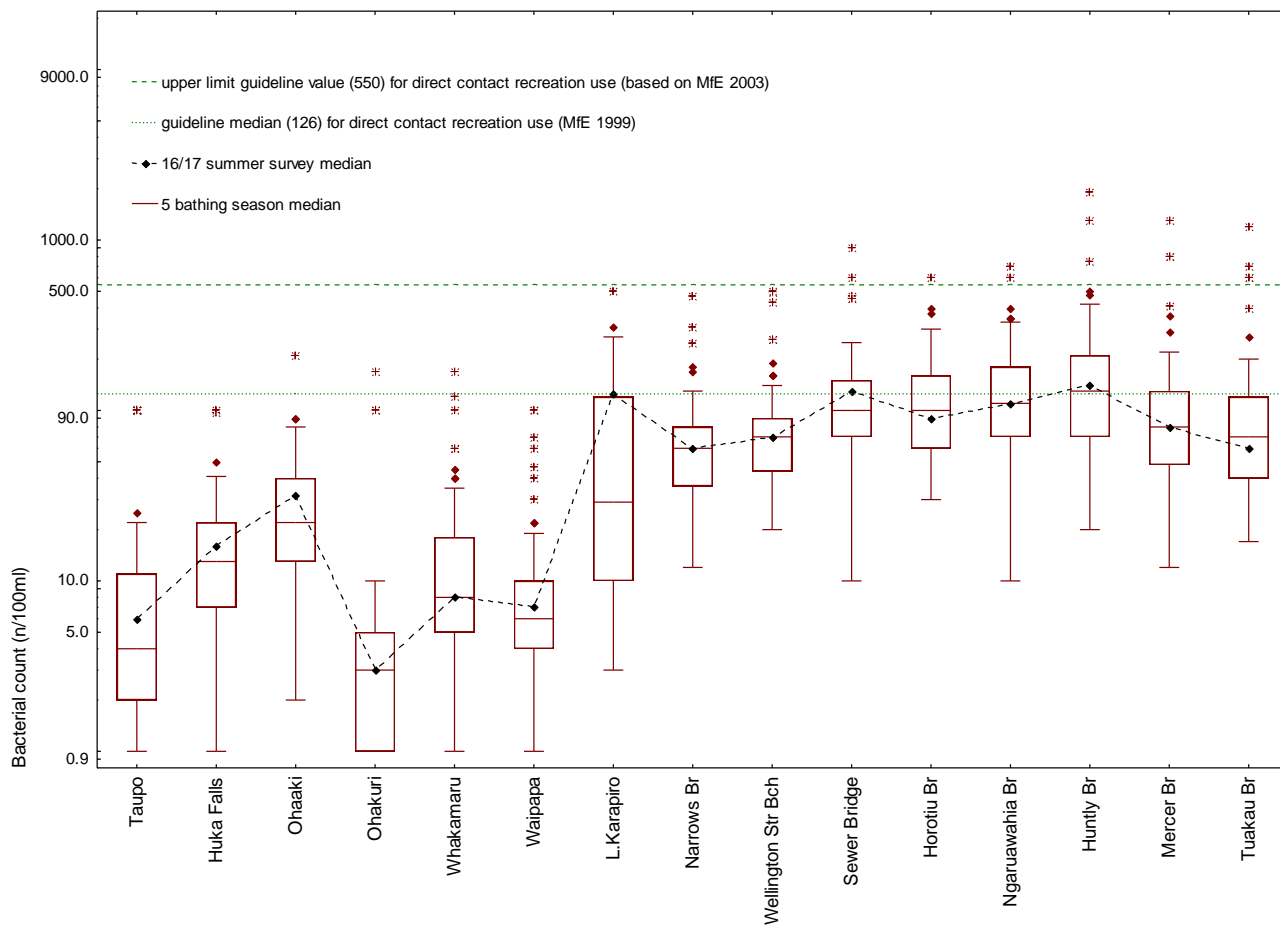

Figure 2: E. coli - five years of bathing season data

References

- Smith P 2006. Waikato River water quality monitoring programme data report 2005. Environment Waikato Technical Report 2006/34. Hamilton, Waikato Regional Council (Environment Waikato)
- Tulagi A 2016. Waikato River water quality monitoring programme data report 2015. Waikato Regional Council Technical Report 2016/33. Hamilton, Waikato Regional Council
- Tulagi A 2013. Waikato River water quality monitoring programme data report 2012. Waikato Regional Council Technical Report 2013/12. Hamilton, Waikato Regional Council
- Tulagi A 2012. Waikato River water quality monitoring programme data report 2011. Waikato Regional Council Technical Report 2012/22R. Hamilton, Waikato Regional Council
- Vant B 2013. Trends in river water quality in the Waikato region, 1993-2012. Waikato Regional Council Technical Report 2013/20, Hamilton, Waikato Regional Council

Appendix I:

Flow information

Median Flows of the Waikato River and Main Tributaries

Location	DISTANCE	FLOW RATE+ (m ³ /s)										10 YEAR
	km	2007	2008	2009	2010	2011	2012	2013	2014	2015	2016	Median
Taupo	4.2	130	129	134	104	185	194	93	99	104	117	123
Ohakuri	75.8	157	163	162	192	225	229	163	163	184	190	174
Whakamaru	105.0	178	186	196	209	242	232	168	167	189	206	192
Waipapa	126.1	190	211	194	198	250	245	175	171	186	205	196
Hamilton	211.5	219	220	224	205	241	261	177	195	201	228	220
Huntly	246.5	278	273	301	296	339	346	263	260	281	285	283
Mercer	286.3	313	302	334	304	341	358	286	280	302	314	308
Waiotapu Stm	46.6	2.8	3.0	2.7	3.3	3.8	3.5	2.5	2.4	2.6	2.8	3
Waipa River	232.7	34	43	53	41	61	62	47	55	53	59	53

+Rating curve errors mean estimates of flow are ± 8%

*Historical flow data updated due to rating changes from updated data received

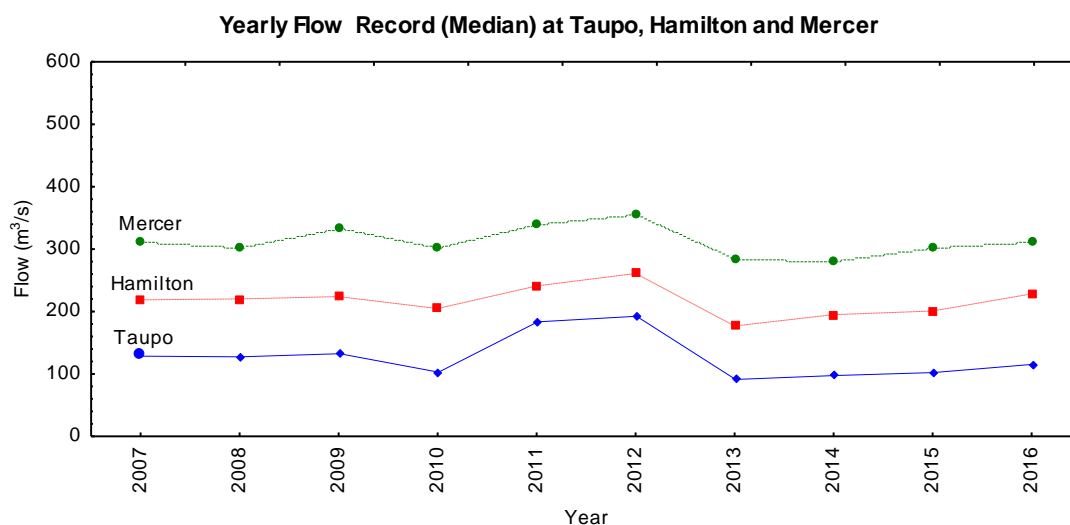
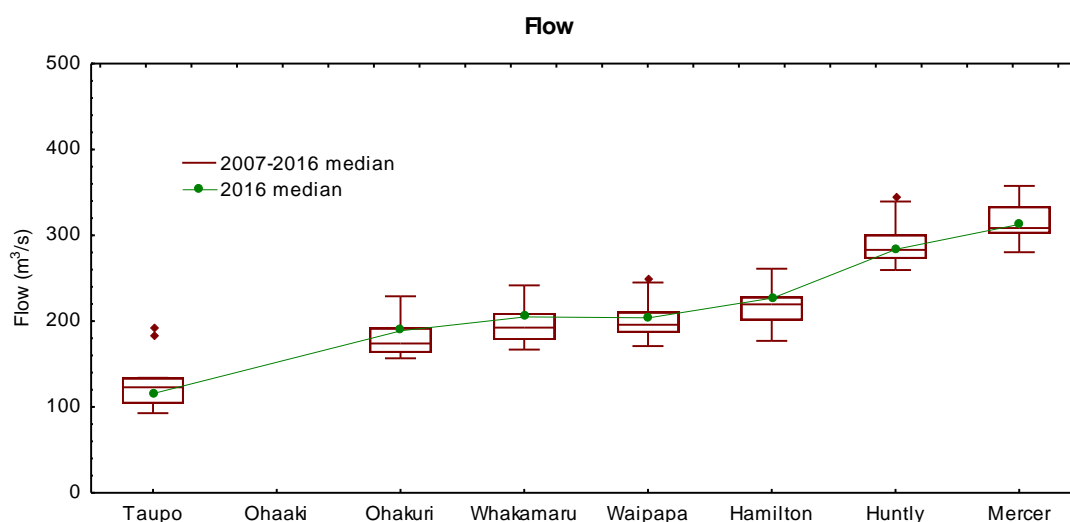

Appendix II

Datasonde deployments

Diurnal variation of selected water quality parameters

Temperature: Upper Waikato (March - May)

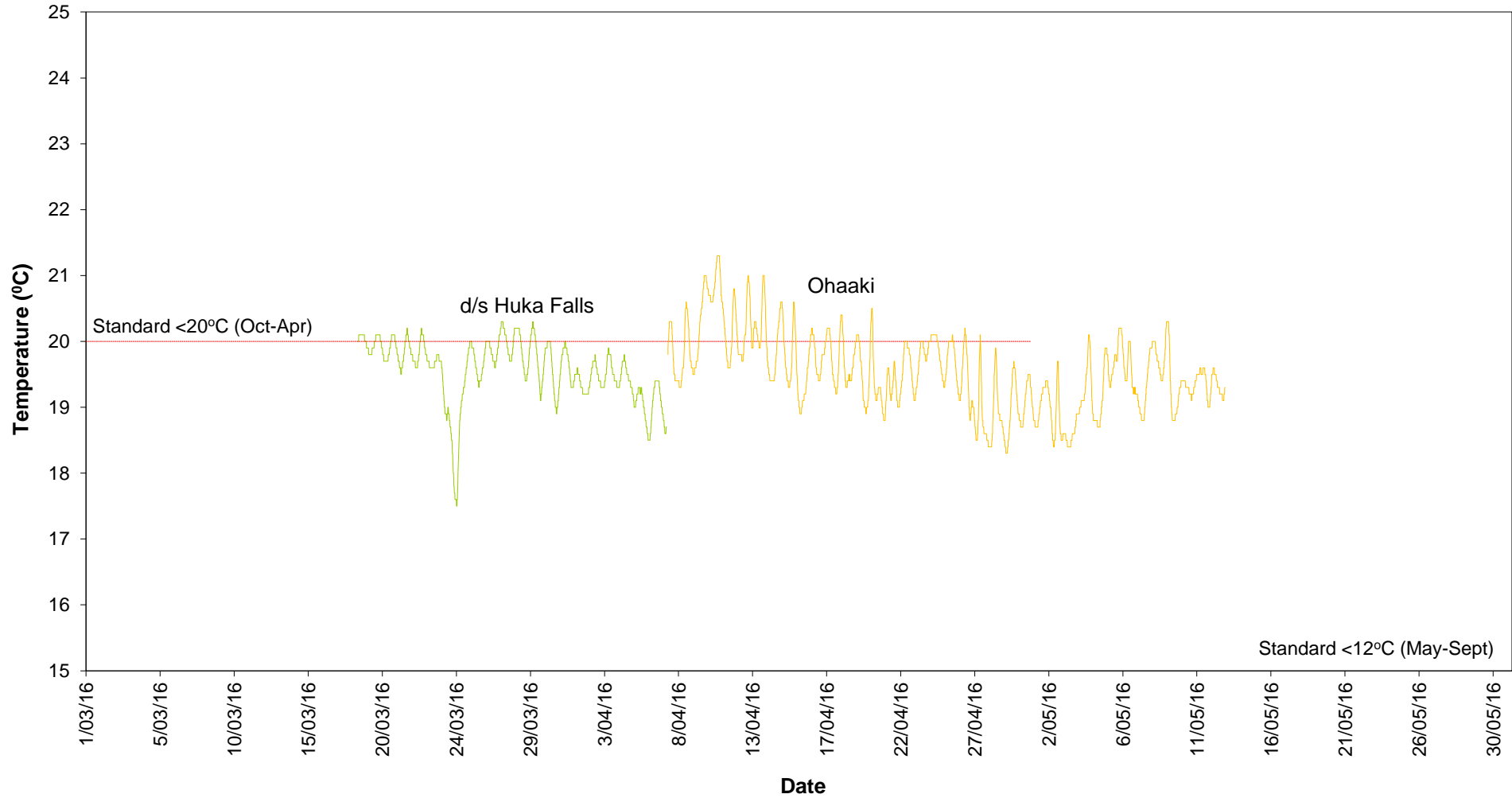

pH: Upper Waikato (March - May)

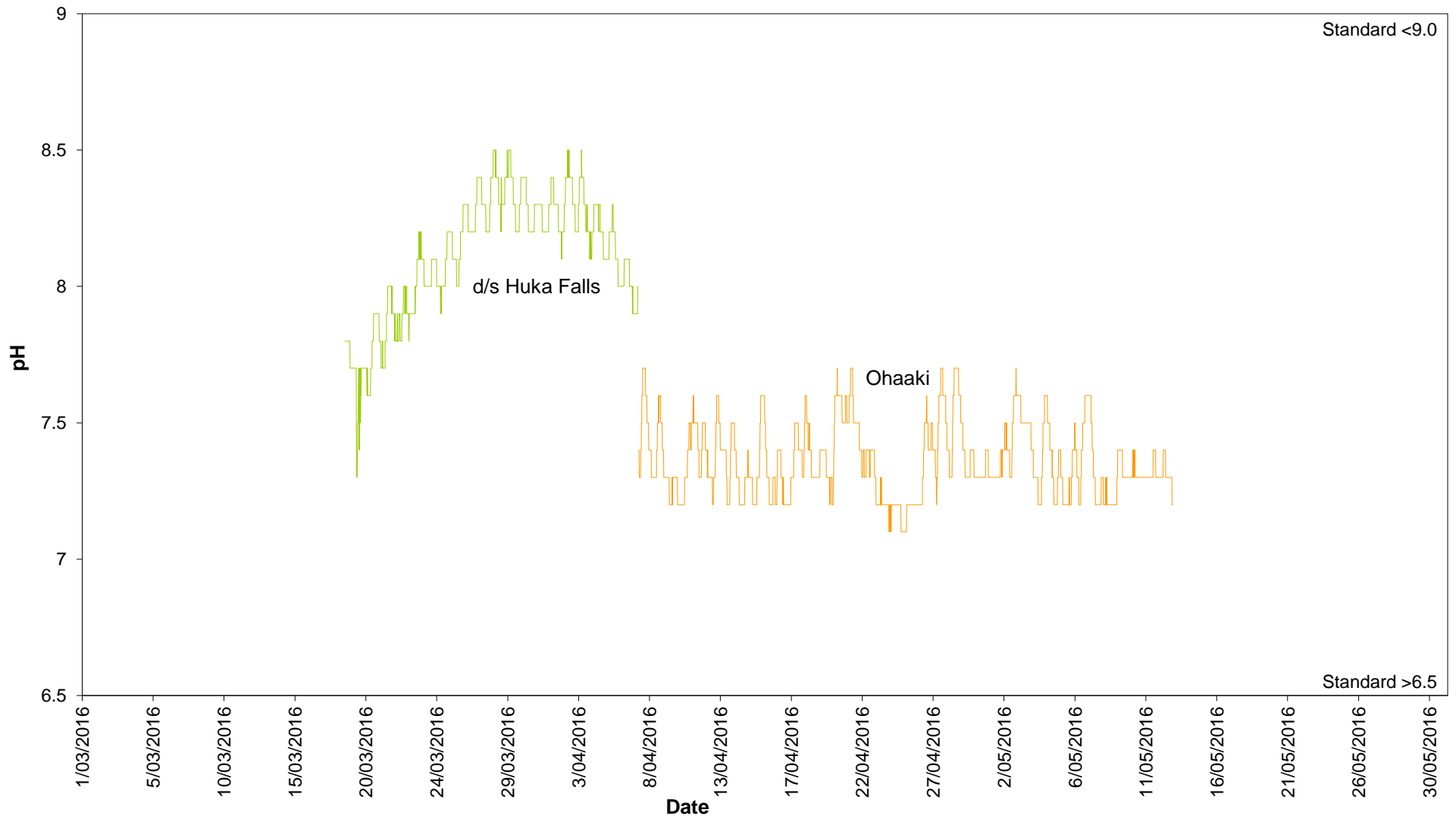

Dissolved Oxygen, % saturation: Upper Waikato (March - May)

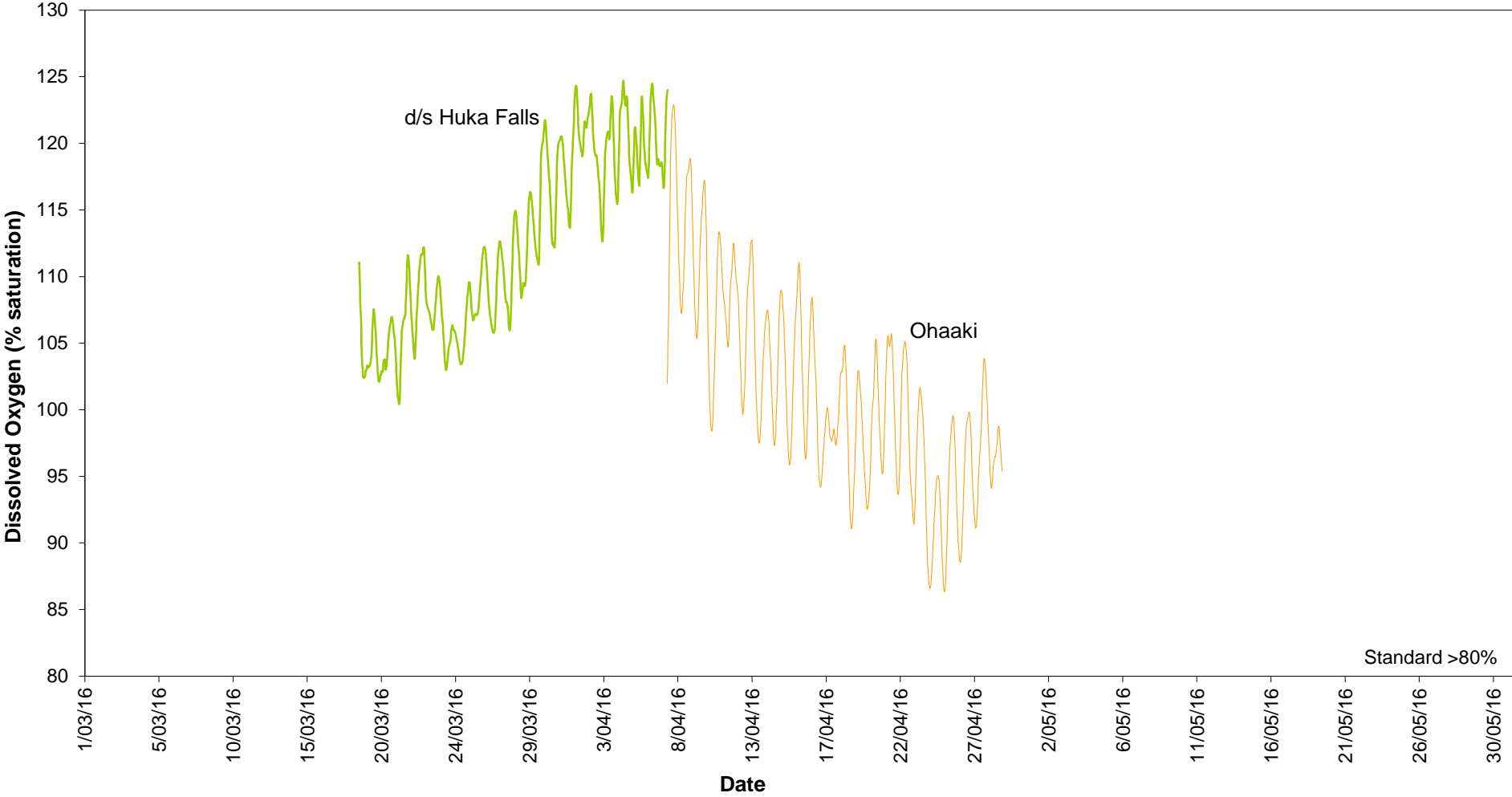

Temperature: Lower Waikato (January - June)

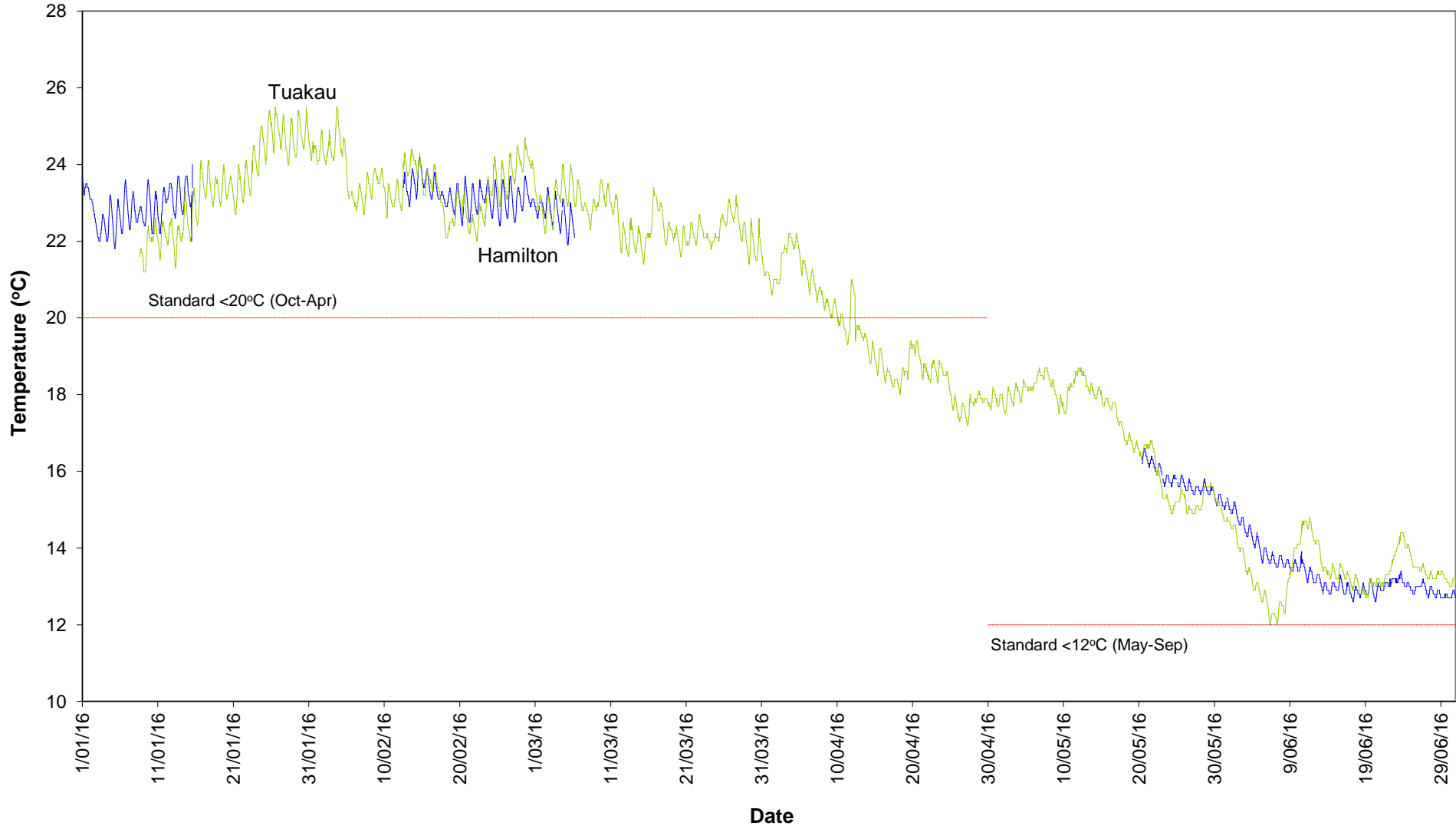

pH: Lower Waikato (January - June)

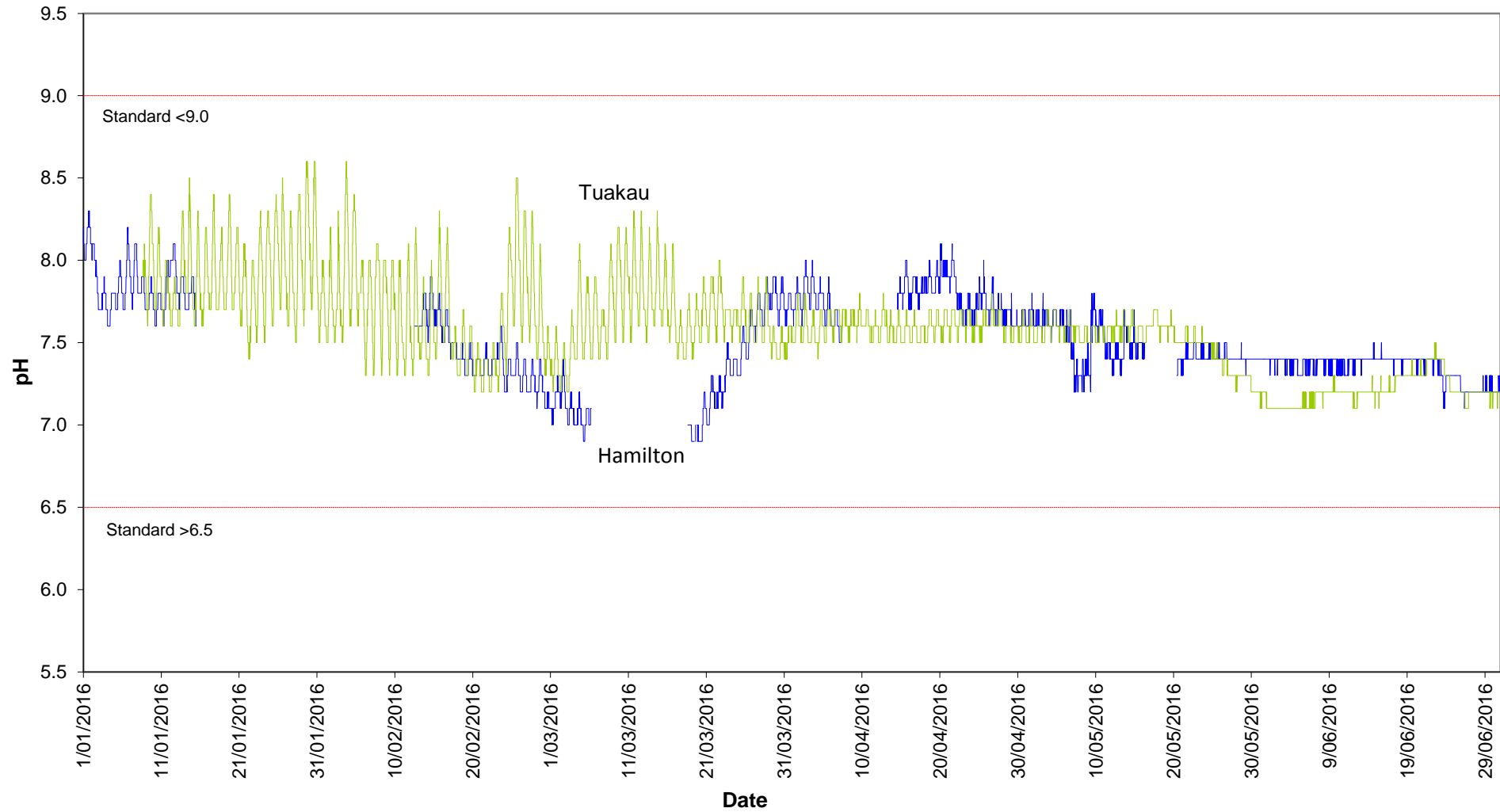

Dissolved Oxygen (% saturation): Lower Waikato (January - June)

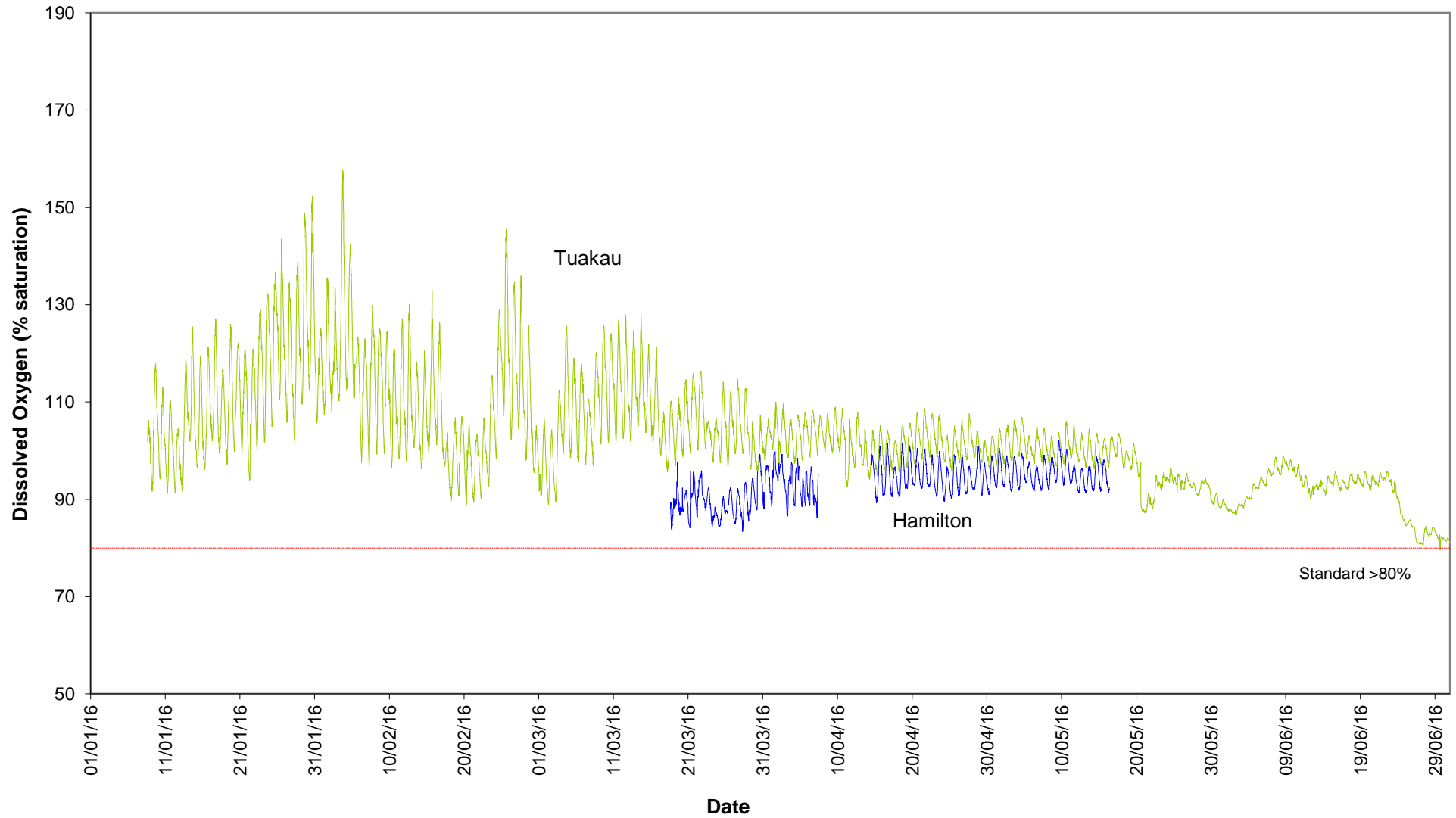

Chlorophyll a: Lower Waikato (January - June)

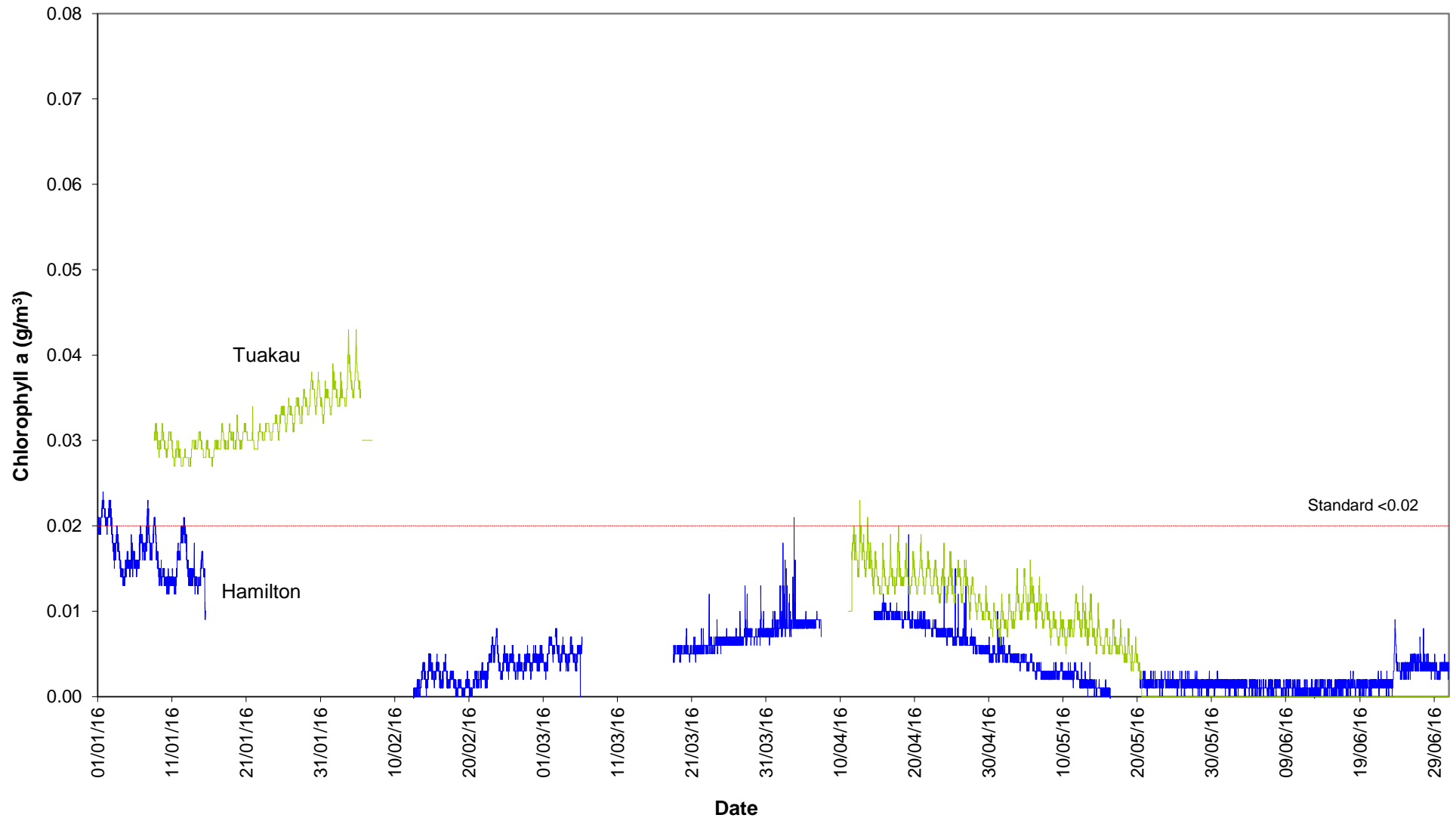

Temperature: Lower Waikato (July - December)

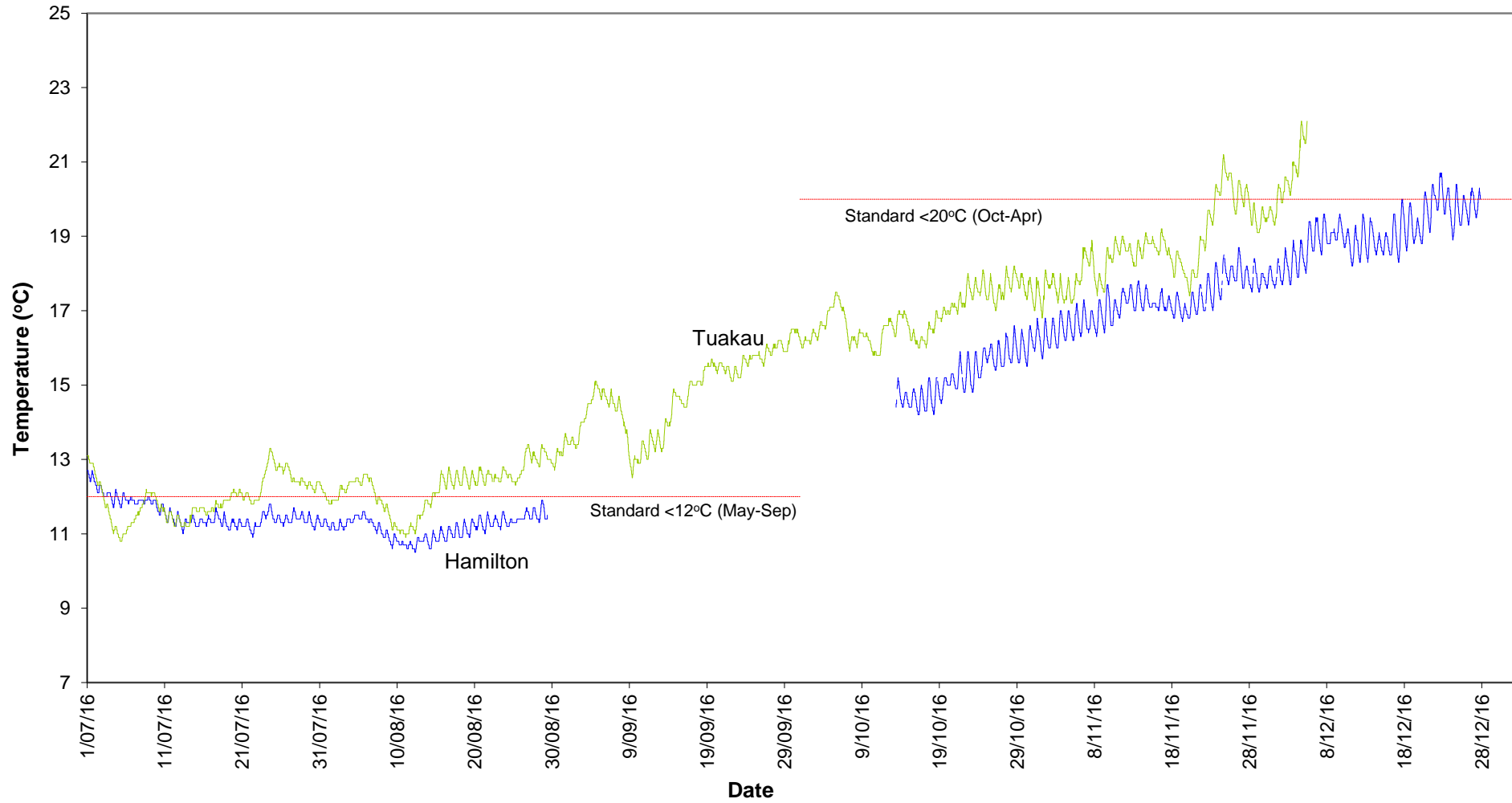

pH: Lower Waikato (July - December)

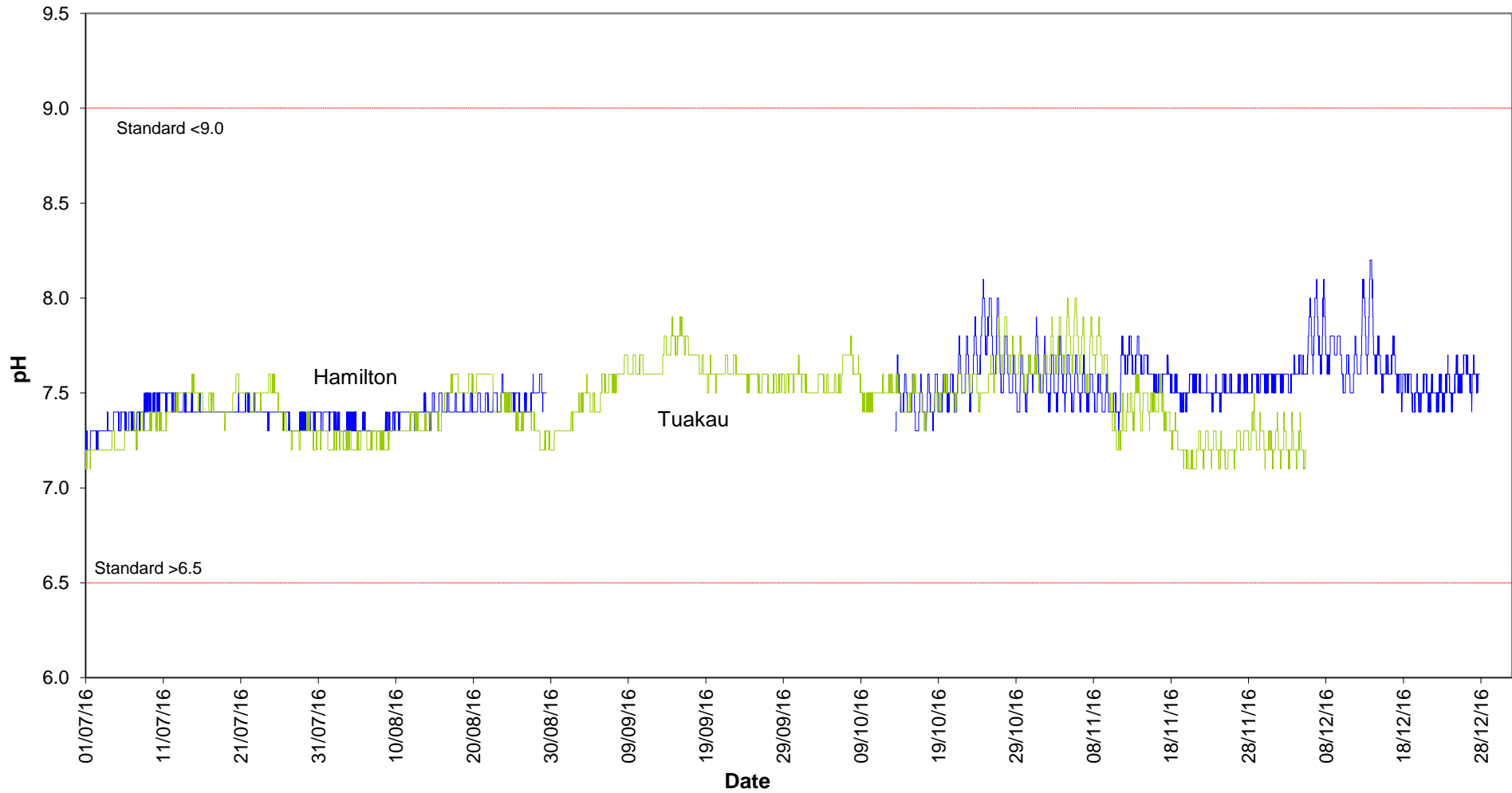

Dissolved Oxygen (% saturation): Lower Waikato (July - December)

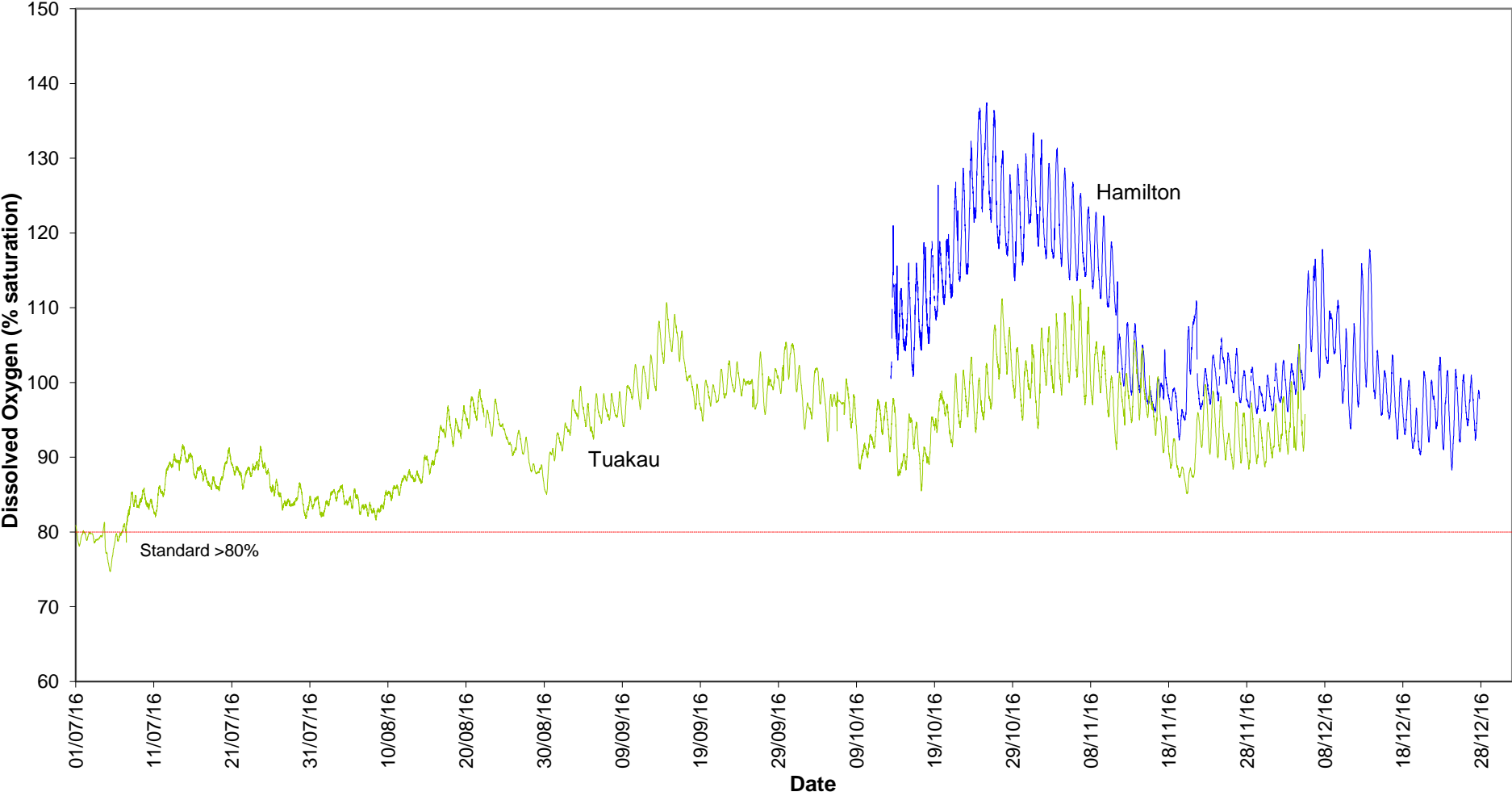

Chlorophyll a: Lower Waikato (July - December)

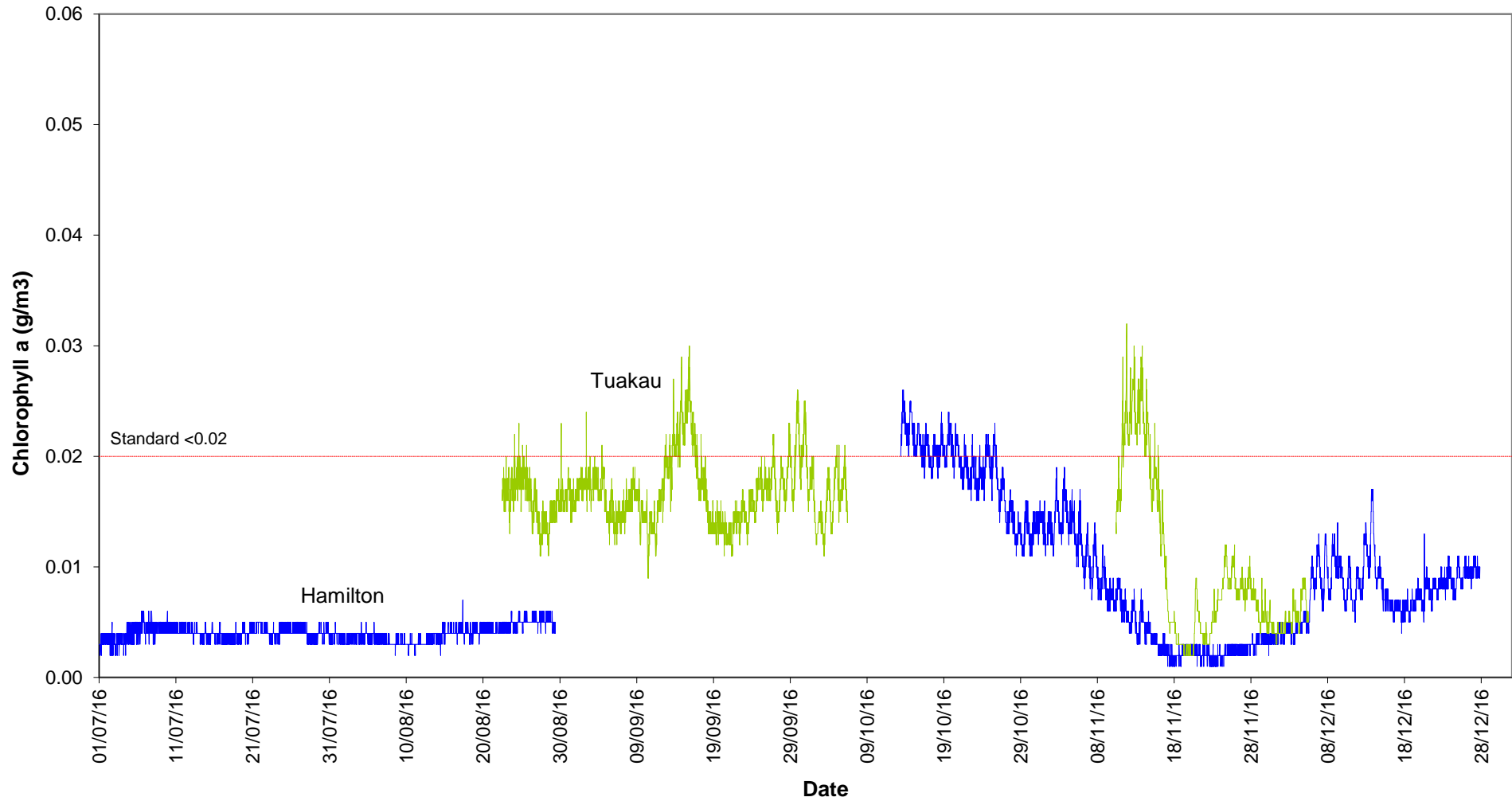

Appendix III:

Water quality parameters

Guidelines and standards

Analytical methods

Waikato River water quality monitoring programme parameters

Water quality parameter	Reason for monitoring	Parameter monitored ¹	Comments ²
Dissolved oxygen	- requirement for aquatic life	DO (conc.)	routine (field)
	- indicator of organic pollution	DO (%sat.)	routine (field)
	- indicator of photosynthesis (plant growth)		
Temperature	- indicator of biological activity	Temperature	routine (field)
	- requirement for aquatic life		
	- mixing processes		
	- modelling studies (e.g. nutrient uptake)		
Conductivity	- indicator of total salts dissolved in water	Conductivity	routine
	- indicator for geothermal input	TDS	routine
pH	- aquatic life protection	pH	routine
	- indicator of industrial discharges, mining		
Clarity - turbidity - black disk (visual clarity)	- aesthetic appearance	Turbidity	routine
	- light availability for excessive plant growth	Black disk	routine (field)
	- aquatic life protection		
	- indicator of catchment condition, land use		
Colour - light absorption	- aesthetic appearance	Munsell colour	routine (field)
	- light availability for excessive plant growth	Absorbance at:	routine
	- indicator of presence of organic matter	340,440,780nm	
Nutrients (N and P) chlorophyll <i>a</i>	- enrichment, excessive plant growth	NO ₃ -N+NO ₂ -N	routine
	- nutrient limitation for plant/algal growth	NH ₄ -N,TKN	
		DRP, TP, Chl <i>a</i>	
Geothermal contaminants	- indicators of geothermal inflows	Cl, Li, B, As	routine
	- aquatic life protection (ecotoxicity)		
	- drinking water (human health aspects)		
Organic carbon	- indicator of organic pollution	BOD ₅	routine
	- catchment characteristics	TOC/DOC	routine
Faecal bacteria - E. coli - enterococci - faecal coliforms	- indicator of pollution with faecal matter	E. Coli	routine
	- disease risk for swimming etc.	ENT	routine
		FC	routine

¹ see the page 49 for the meaning of the abbreviations.

² routine means sampled monthly.

Details of water quality standards and guidelines for “satisfactory” water quality

Parameter	Critical value(s)	Source
Dissolved oxygen	>80% of saturation concentration	RMA Third Schedule, Classes AE, F, and FS.
pH	6.5–9	ANZECC (1992) and Canadian guidelines for freshwater aquatic life (1987).
Turbidity	<5 NTU	Studies of adverse effects on underwater light—and thus on plant and invertebrate production—in certain South Island streams (Davies-Colley 1991).
Ammoniacal-nitrogen	<0.88 g/m ³	USEPA (1998) value for 1-hour exposure at pH 9.
Temperature	<12°C (May – Sep) <20°C (Oct – Apr)	Waikato Regional Council Proposed Regional Plan standards for trout fisheries and trout spawning (1998).
Total phosphorus	<0.04 g/m ³	From upper quartile values for 77 New Zealand rivers in NIWA’s National Water Quality Network (after Smith & Maasdam 1994)—note that the guidelines for “excellent” conditions are the lower quartile concentrations for these rivers.
Total nitrogen	<0.5 g/m ³	From upper quartile values for 77 New Zealand rivers in NIWA’s National Water Quality Network (after Smith & Maasdam 1994)—note that the guidelines for “excellent” conditions are the lower quartile concentrations for these rivers.
Water clarity at baseflow	>1.6 m	“Baseflow” defined as flows less than the upper decile flow. Guideline from Ministry for the Environment (1994).
Escherichia coli	<550/100 mL	Ministry for the Environment (2003) guidelines for the management of recreational and marine shellfish-gathering waters.
Median Escherichia coli	<126/100 mL	Ministry for the Environment (1999) guidelines for the management of recreational and marine shellfish-gathering waters.
Enterococci	<77/100 mL	Department of Health (1992) guidelines for “moderate” level of recreational use.
Chlorophyll <i>a</i>	<0.02 g/m ³	Ministry for the Environment (1992).
Arsenic	<0.01 g/m ³	Ministry of Health (2001).
Boron	<1.4 g/m ³	Ministry of Health (2001).

Waikato River monitoring programme - water quality parameters and analytical methods

Id ¹	Parameter	Method
A340F	Absorbance @ 340 nm filtered	Spectrophotometer, 1 cm path length, APHA method 5910B
A440F	Absorbance @ 440 nm filtered	Spectrophotometer, 1 cm path length, APHA method 5910B
A780F	Absorbance @ 780 nm filtered	Spectrophotometer, 1 cm path length, APHA method 5910B
As	Arsenic total	Nitric acid digestion, ICP-MS, APHA method 3125 B / USEPA 200B
B	Boron	ICP-MS, APHA method 3125 B
BDISK	Black disk	Field measurement, horizontal water transparency (20mm, 60mm, 100mm, 200mm disk) in river
BOD ₅	Biochemical oxygen Demand (5 day)	Incubation 5 days at 20°C, DO-meter, No nitrification inhibitor added, unseeded, APHA method 5210 B
CHLA	Chlorophyll a	Acetone extraction. Spectroscopy. APHA method 10200 H (modified)
Cl	Chloride	Filtered sample. Ferric thiocyanate colorimetry, Discrete analyser. APHA method 4500 Cl ⁻ E (modified)
COLOUR	Colour	Field measurement, Munsell colour patches
COND	Conductivity	Lab Meter @ 25°C. APHA method 2510B
DO	Dissolved oxygen	Field measurement (Hach DO meter, model HQ 30d)
DO (% Sat)	Dissolved oxygen (percent saturation)	Field measurement (Hach DO meter, model HQ 30d)
DOC	Dissolved organic Carbon	Filtration, acidification, purging to remove inorganic C, persulphate oxidation, IR detection. APHA method 5310 C (modified)
DRP	Dissolved reactive Phosphorus	Filtration, Molybdenum Blue Colorimetry. Discrete analyser. APHA 4500 PE (modified)
E. coli	Escherichia coli	Membrane Filtration (mFC Agar) confirmation by MUG Agar. APHA method 9222 G
ENT	Enterococci bacteria	Membrane Filtration (mE Agar) confirmation by EIA Agar. APHA method 9230 C
FC	Faecal coliforms	Membrane Filtration (mFC Agar). APHA method 9222 D
Flow	Flow – instantaneous	Calculated from rating curve ± 8%
Li	Lithium	ICP-MS, method APHA 3125 B
NH ₄ -N	Ammoniacal Nitrogen (Total)	Filtration, Phenol/Hypochlorite Colorimetry. Discrete analyser. APHA method 4500-NH ₃ F (modified).
NNN	Nitrite/Nitrate Nitrogen	Automated Cadmium reduction. Flow injection analyser. APHA method 4500 – NO ₃ ⁻ I (modified)
NO ₃ -N	Nitrate nitrogen	Calculation: (Nitrate-N + Nitrite –N) – Nitrite - N
pH	pH	Lab Meter @ 25°C. APHA method 4500-H ⁺ B
TDS	Total dissolved solids	Filtration, gravimetric. APHA 2540 C (modified)
TEMP	Temperature	Field measurement (Hach DO meter, model HQ 30d)
TKN	Total Kjeldahl-Nitrogen	Acid digestion. Phenol/Hypochlorite colorimetry. Discrete analyser. APHA method 4500-N _{org} D (modified), 4500 NH ₃ F (modified)
TOC	Total Organic Carbon	Acidification, purging to remove inorganic C, persulphate oxidation, IR detection. APHA method 5310 C (modified)
TN	Total Nitrogen	Calculated from NNN + TKN (Nitrite/Nitrate Nitrogen + Total Kjeldahl-Nitrogen)
TP	Total Phosphorus	Acid persulphate digestion, Colorimetry. Discrete Analyser. APHA method 4500-P B & E (modified), corrected values to take into account possible interference from arsenic present in the sample.
TURB	Turbidity	Turbidity Meter Hach 2100N. APHA method 2130 B

¹ Water quality parameter identification code refers to Waikato Regional Council's water quality database (WISKI) parameter short name.

APHA = Standards Methods for the Examination of Water and Wastewater, 22nd Edition, 2012, APHA, AWWA, WEF

ICP-MS = Inductively Coupled Plasma – Mass Spectroscopy